

INTEPRO **SYSTEMS**

AFV-P Series

Programmable AC & DC Power Supply

User Manual

Intepro Systems

V 1.05.01

The information in this document is subject to change without notice. Copyright by Intepro Systems. All rights reserved

Legal Notices

The information in this product manual is subject to change without notice.

Intepro Systems makes no warranty of any kind with regard to this user manual, including, but not limited to, the implied warranties of merchantability and fitness for a particular purpose. Intepro Systems shall not be held liable for errors contained herein or direct, indirect, special, incidental or consequential damages in connection with the furnishing, performance, or use of this material.

Copyright Notices. Copyright 2017 Intepro Systems, all rights reserved. Reproduction, adaptation, or translation of this document without prior written per-mission is prohibited, except as allowed under the copyright laws.

Warranty

Intepro's AFV-P series is warranted against defects in material and workmanship for a period of two year after date of shipment. Intepro agrees to repair or replace any assembly or component found to be defective, under normal use during this period. Intepro's obligation under this warranty is limited solely to repairing any such product which in sole Preen's opinion proves to be defective within the scope of the warranty when returned to the factory or to an authorized service center. Transportation to the factory or service center is to be prepaid by the purchaser. Shipment should not be made without prior authorization by Intepro.

This warranty does not apply to any products repaired or altered by persons not authorized by Intepro, or not in accordance with instructions furnished by Intepro. If the product is defective as a result of misuse, improper repair, or abnormal conditions or operations, repairs will be billed at cost.

Intepro assumes no responsibility for its product being used in a hazardous or dangerous manner either alone or in conjunction with other equipment. High voltage used in some products may be dangerous if misused. Special disclaimers apply to these products. Intepro Systems assumes no liability for secondary charges or consequential damages and in any event, Preen's liability for breach of warranty under any contract or otherwise, shall not exceed the purchase price of the specific product shipped and against which a claim is made.

Any recommendations made by Intepro Systems for use of its products are based upon tests believed to be reliable, but Intepro makes no warranty of the results to be obtained. This warranty is in lieu of all other warranties, expressed or implied, and no representative or person is authorized to represent or assume for Intepro any liability in connection with the sale of our products other than set forth herein.

Intepro Systems

USA

14712 Franklin Ave, Tustin, CA, 92780

TEL +1 714 953 2686

UK

9 Lakeside Business Park, Swan Lane, Sandhurst Berkshire GU47 9DN

TEL +44 012 5287 5600

China

No. 828, Block 7, Fourth Industrial Area, Nanyou, Nanshan District, Shenzhen

TEL +0086 755 86500020

SAFETY SUMMARY

The following general safety precautions must be observed during all phases of operation, service, and repair of this product. Failure to comply with these precautions or specific WARNINGS given elsewhere in this manual will violate safety standards of design, manufacture, and intended use of the product.

Intepro Systems assumes no liability for the customer's failure to comply with these requirements.

BEFORE APPLYING POWER

Verify that the product is set to match with the power line input.

PROTECTIVE GROUNDING

Make sure to connect the product to the protective ground to prevent an electric shock before turning on the power.

NECESSITY OF PROTECTIVE GROUNDING

Never cut off the internal or external protective grounding wire, or disconnect the wiring of protective grounding terminal. Doing so will cause a potential shock hazard that may bring injury to a person.

DO NOT OPERATE IN AN EXPLOSIVE ATMOSPHERE

Do not operate the product in the presence of flammable gases or fumes.

DO NOT REMOVE THE COVER OF THE PRODUCT

Personnel who operate the product must not remove the cover of the product. Component replacement and internal adjustment can be done only by qualified service personnel.

WARNING

LETHAL VOLTAGES. The product can supply 440V peak at its output. DEATH on contact may result if either the output terminals or the output circuits connected to the output are touched when the product output is on.

Table of Contents

1 GENERAL INFORMATION	1
1.1 Introduction	1
1.2 Key Features	2
1.3 Specifications	3
1.4 Exterior	5
1.5 Name of Parts	6
2 INSTALLATION	9
2.1 Inspection	9
2.2 User Preparation	9
2.3 Input Connection	9
2.4 Output Connection	10
2.5 Remote Sense Connection	11
2.6 Power-on Procedures	12
2.7 Product Handle Installation	13
2.8 Interface Card Installation	13
2.8.1 RS232/RS485 9-Pin D-Type Connector	14
2.8.2 PLC Remote Input Connector	14
2.8.3 PLC Remote Output Connector	15
3 LOCAL OPERATION	16
3.1 General	16
3.2 Operation via the Touch Screen and the Rotary Knob	16
3.3 MAIN Page	18
3.3.1 Output Voltage Range.....	19
3.4 MENU Page	20
3.5 SETTINGS Page	21
3.5.1 TESTING Subpage (ADVANCED Mode).....	21
3.5.2 TESTING Subpage (BASIC Mode)	32

3.5.3 SYSTEM Subpage.....	39
3.6 COMMUNICATION Page.....	45
3.6.1 ETHERNET Subpage	45
3.6.2 GENERAL Subpage	46
3.6.3 GENERAL Subpage with GPIB interface (optional)	47
3.7 RESULTS Page	48
3.8 WAVE Page.....	49
3.9 METER Page	51
3.10 INFORMATION Page.....	53
3.11 Protection	54
4 CALIBRATION	56
4.1 HI-Range Voltage 310V	58
4.2 LO-Range Voltage 155V	59
4.3 HI-Range Voltage 60V	60
4.4 LO-Range Voltage 60V	61
4.5 HI-Range RMS Current.....	63
4.6 LO-Range RMS Current	64
4.7 Peak Current	65
4.8 Output Socket Current (Specialize for AFV-P-5000).....	67
5 PROGRAMMABLE FEATURES	69
5.1 General	69
5.2 STEP Feature	73
5.3 RAMP Feature	83
5.4 TRANSIENT Feature	85
6 THEORY OF OPERATION.....	88
7 REMOTE OPERATION.....	89
7.1 General	89

7.2 Remote Control Software: General Mode	91
7.3 Remote Control Software: Program Mode	94
7.4 Remote Control Software: Additional Features	96

1 General Information

1.1 Introduction

Preen’s AFV-P series is a programmable AC power supply with DC output and precision measurements. This compact power supply comes in four power levels, 600VA, 1250VA, 2500VA and 5000VA, which provides stable output voltage and output frequency with low distortion. The PWM design of power stage allows for full volt-ampere into loads. The front panel has both touch screen and rotary knob for setting the product output, which provide an easy operation and measurement reading display. Remote control for the product can be accomplished selectively via RS232, RS485, Ethernet, USB or GPIB.

The following figures show the V/I curve according to the AC & DC output of the product, which can be applied to any product model and any output voltage range of the product.

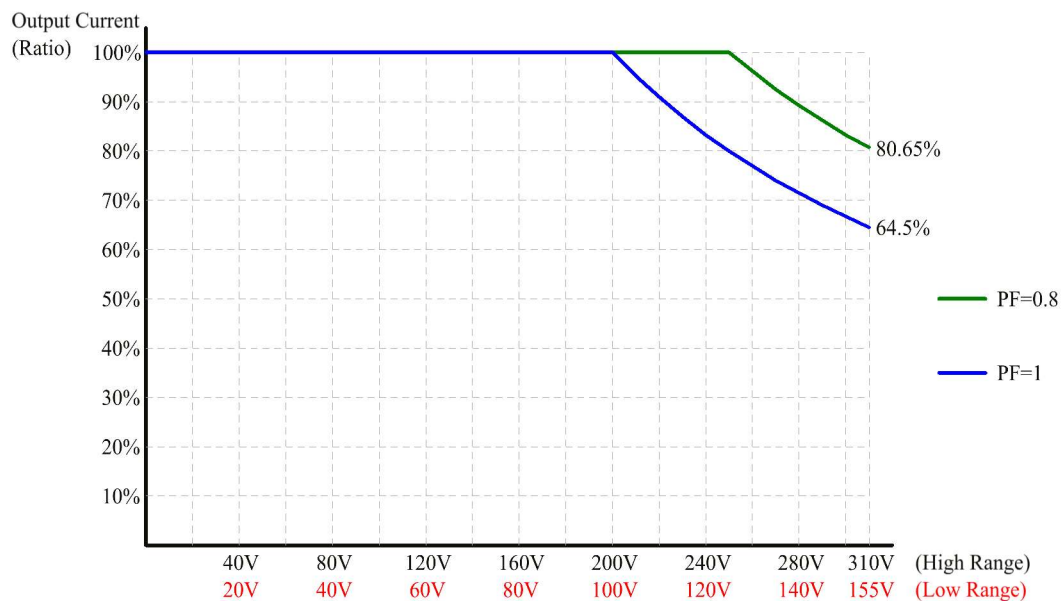

Figure 1.1 V/I curve for the AC output of the product

NOTICE

If the Power Factor (PF) corresponding to the AC output is less than 0.65, 100% output current can be achieved under 0%-100% output voltage, which can be applied to any product model and any output voltage range of the product.

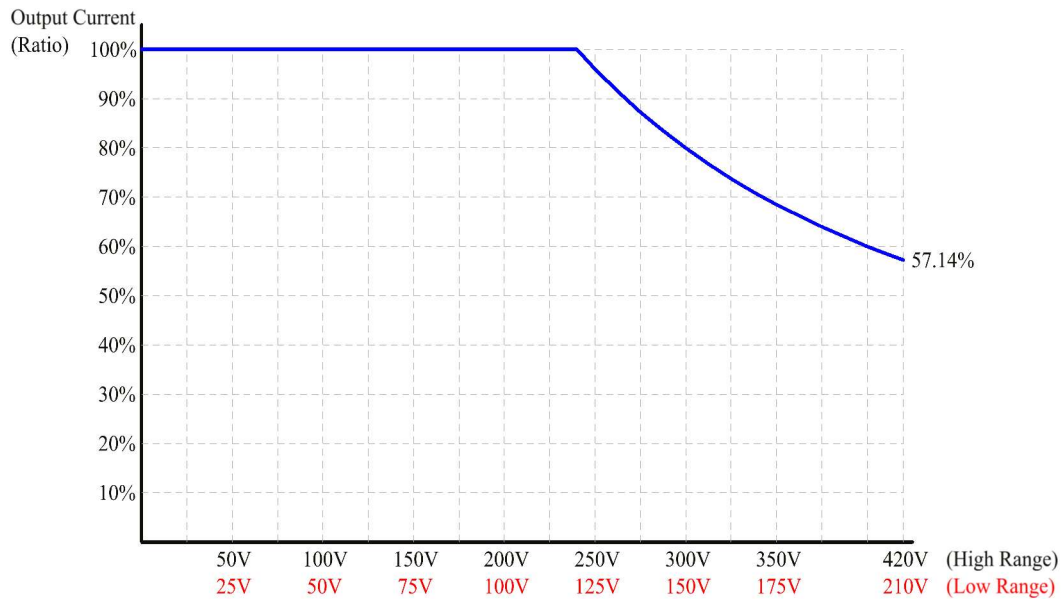

Figure 1.2 V/I curve for the DC output of the product

1.2 Key Features

A. Configuration

1. Local operation via the touch screen and the rotary knob on the front panel.
2. Remote control via RS232, RS485, Ethernet, USB or GPIB.
3. Protection for OVP, LVP, OCP, OPP, OTP, RCP, Fan Fail and AMP Fail.
4. Temperature-controlled fan speed.

B. Input / Output

1. Selective output voltage range with full scale 310V/Auto.
2. Universal input voltage range 98~132V_{AC}/196~264V_{AC}.
3. Wide output voltage from 0 to 310V_{AC} & output frequency from 15 to 1000Hz.
4. Measurement readings of V, I, P, VA, VAR, f , I_{pk} , CF and PF.
5. Output of Synchronized signal.

1.3 Specifications

Technical specifications of product are listed below. All specifications have been tested according to Preen's standard test procedures.

Model	AFV-P-600	AFV-P-1250	AFV-P-2500	AFV-P-5000
AC Input				
Phase	Single			
Input Voltage Range	98-132V _{ac} /196-264V _{ac}		196-264V _{ac} /175-235V _{ac}	
Input Frequency	47~63Hz			
Max. Current	10A	20A	20A	40A
AC Output				
Power (VA)	600VA	1250VA	2500VA	5000VA
Power (W)	500W	1000W	2000W	4000W
Phase	1 ϕ /2 Wire + G			
Voltage Range	0-155V _{rms} /0-310V _{rms}			
Voltage Resolution	0.1V _{rms}			
Frequency	40-500Hz (opt. 15-1000Hz)			
Frequency Resolution	0.1Hz, at 15-100Hz; 1Hz, at 100-1000Hz			
Max. Current (RMS)	5A/2.5A	10A/5A	20A/10A	40A/20A
Max. Current (Peak)	22.5A/11.3A	45A/22.5A	90A/45A	180A/90A
Total Harmonic Distortion (THD)	$\leq 0.3\%$, at 40-100Hz; $\leq 0.5\%$, at 101-500Hz; $\leq 0.8\%$, at 501-1000Hz (Resistive Load)			
Line Regulation	$\pm 0.1V$			
Load Regulation	$\leq 0.07\%$ F.S (Resistive Load)			
Response Time	$\leq 300\mu s$			
Crest Factor	≥ 3			
Inrush Current	≥ 4.5 peak current/RMS current			
DC Output				
Power	300W	600W	1250W	2500W
Voltage Range	0-210V/0-420V			
Max. Current	2.5A/1.25A	5A/2.5A	10A/5A	20A/10A
Ripple & Noise (RMS)	$\leq 0.15\%$			$\leq 0.24\%$
Measurement				
Voltage Range	0-420V			
Voltage Accuracy	$\pm(0.2\%$ of Reading + 5 Counts)			
Voltage Resolution	0.1V			

AFV-P Series User Manual

Frequency Range	15-1000Hz		
Frequency Accuracy	±0.1Hz at 40-500Hz; ±0.2Hz at 501-1000Hz		
Frequency Resolution	0.1Hz		
Current Range	Hi: 1-12A/ Lo: 0.005-1.2A	Hi: 2-24A/ Lo: 0.005-2.4A	Hi: 0.05-48A
Current Accuracy	±(1% of Reading + 5 Counts), at 40-500Hz; ±(1% of Reading + 10 Counts), at 501-1000Hz		
Current Resolution	Hi: 0.01A/Lo: 0.001A		Hi: 0.01A
Peak Current Range	0-45A	0-90A	0-180A
Peak Current Accuracy	±(1% of Reading + 5 Counts), at 40-500Hz; ±(1% of Reading + 10 Counts), at 501-1000Hz		
Peak Current Resolution	0.1A		
Power Range	Hi: 100-1200W/ Lo: 0-120W	Hi: 200-2400W/ Lo: 0-240W	Hi: 0-4800W
Power Accuracy	±(2% of Reading + 10 Counts), at 40-500Hz; ±(2% of Reading + 15 Counts), at 501-1000Hz		
Power Resolution	Hi: 1W/Lo: 0.1W		Hi: 1W
General			
Efficiency	≥77% at Max. Power	≥80% at Max. Power	
Protection	OVP, LVP, OCP, OPP, OTP, RCP, Fan Fail and AMP Fail		
Remote Interface	Standard: RS232/RS485/Ethernet/USB/PLC Remote In & Out; Option: GPIB/Analog Control		
Over Current Foldback	Constant Current (CC) Mode		
Synchronized Signal	ON Mode (5V DC Signal) or EVENT Mode (5V DC Pulse Signal)		
Memories	50 Memory Sets & 1200 Steps (24 Steps/Memory Set)		
Operating Temperature	0-40°C		
Dimensions (H×W×D) (mm ³)	89×442×450	89×442×600	222.5×442×600
Weight	Approx. 16kg	Approx. 20kg	Approx. 31.3kg Approx. 70kg

*All specifications are subject to change without notice

Table 1.1 Technical specifications

1.4 Exterior

Product exterior of the AFV-P series are given as follows,

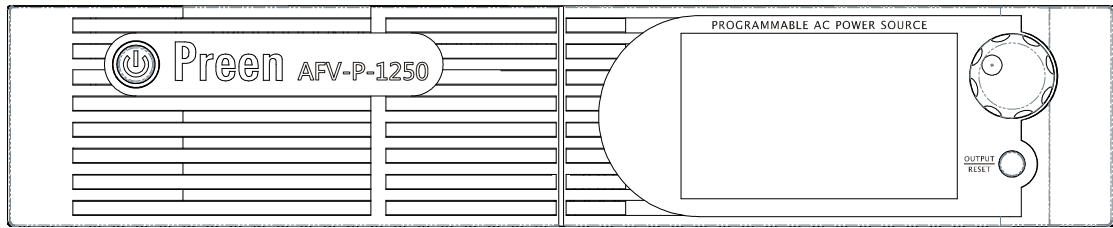

(a) Front-side view of the AFV-P series.

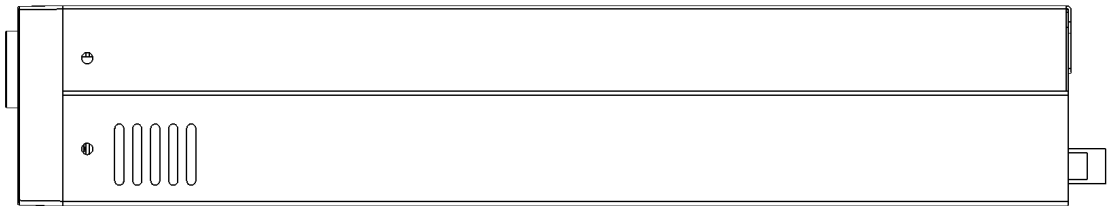

(b) Right-side view of the AFV-P series.

Figure 1.3 Product exterior of the AFV-P series

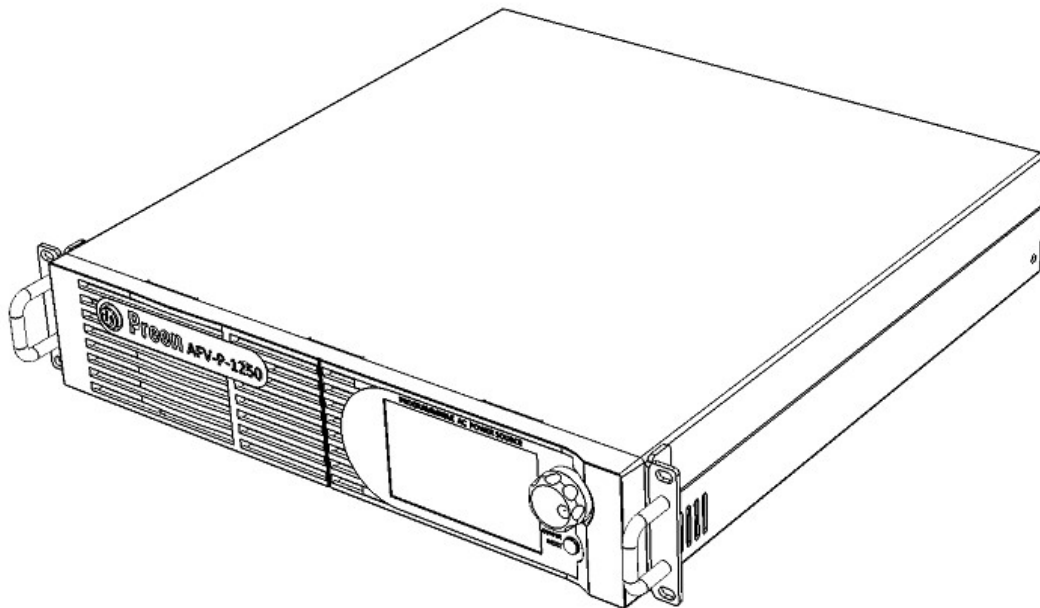

Figure 1.4 Product exterior of the AFV-P series in axis-side view

1.5 Name of Parts

A. Front Panel

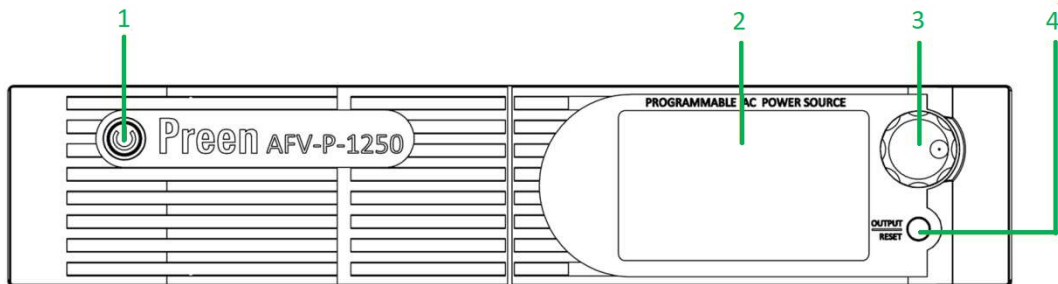

Figure 1.5 Front panel

Item	Name	Description
1	Power Switch	Press this switch to turn on/ turn off the product.
2	Touch Screen	Input programming data or options by manipulating the touch screen to the desired one.
3	Rotary Knob	Input programming data or options by turning the rotary knob to the desired one.
4	Output & Reset Button	Press this button to enable/disable the product output.

B. Rear Panel

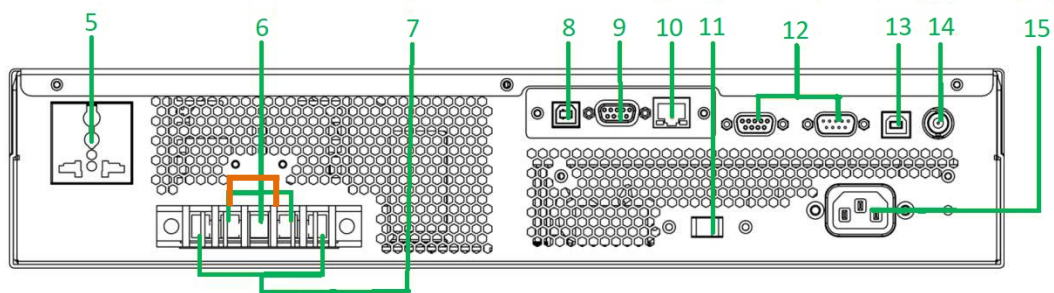

Figure 1.6 Rear panel (for the product model of AFV-P-600)

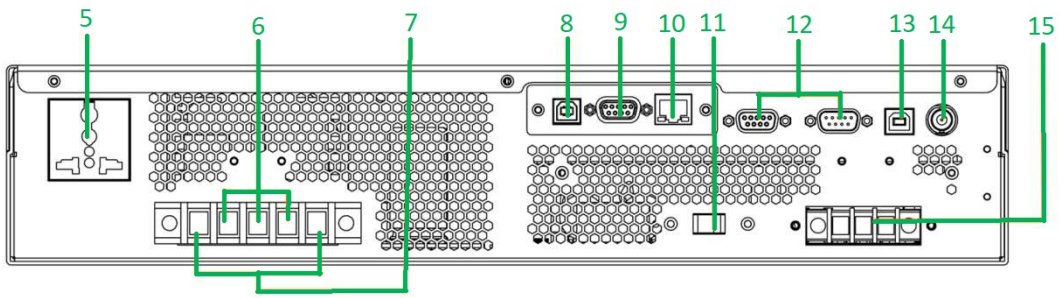

Figure 1.7 Rear panel (for the product models of AFV-P-1250)

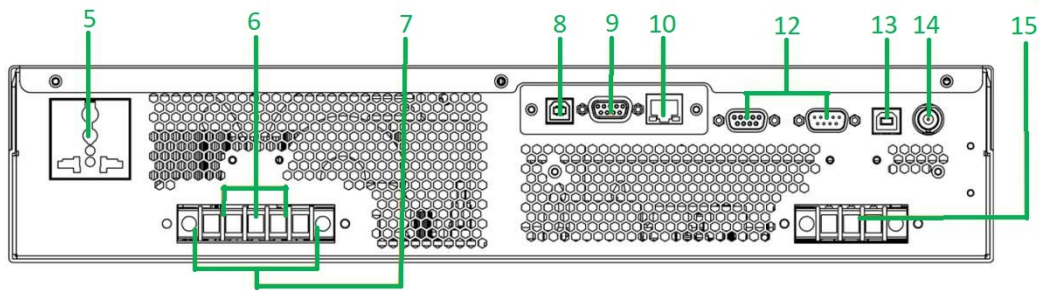

Figure 1.8 Rear panel (for the product models of AFV-P-2500)

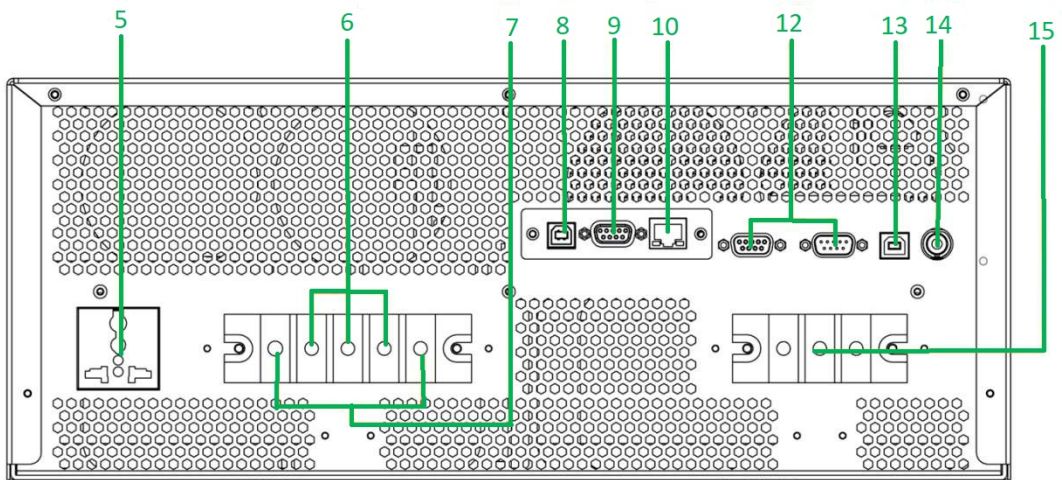

Figure 1.9 Rear panel (for the product model of AFV-P-5000)

Item	Name	Description
5	AC Output Socket	This socket is used to output AC power to the load.
6	Output Terminals	These terminals can output AC & DC power to the load.
7	Remote Sense Connector	<p>This connector senses directly at the terminals of the load to compensate any voltage drop on the connecting cable.</p> <p>NOTICE: Make sure to connect the terminal “S_L” of the remote sense connector to the terminal “L” of the load, and connect the terminal “S_N” of the remote sense connector to the terminal “N” of the load. Notice that reverse polarity is not allowed.</p>
8	USB Interface	This interface is used for remote control via the USB cable.
9	RS232/RS485 Interface	This interface is used for remote control via the RS232/RS485 cable
10	Ethernet Interface	This interface is used for remote control via the Ethernet cable.
11	Input Voltage Selector	<p>Verify this selector is switching to the position (either 115V or 230V) matching the input voltage.</p> <p>NOTICE: This selector is specialized for the product models of AFV-P-600 and AFV-P-1250.</p>
12	PLC Remote In & Out	These interfaces are used for remote control via the PLC programming cable.
13	USB Interface	The interface is used for firmware update via the USB cable.
14	Synchronized Signal I/O	This I/O is used to output synchronized signal via the BNC cable.
15	Input Terminals (AC Inlet)	<p>These terminals are used to connect the product with the power line input.</p> <p>NOTICE: These terminals are replaced by the AC inlet for the product model of AFV-P-600.</p>

2 Installation

2.1 Inspection

After unpacking the product, please inspect any damage that may have occurred during the shipment. Save all packing materials in case the product has to be re-turned one day.

If any damage is found, please file a claim with the carrier immediately. Do not return the product to the factory without obtaining the prior Return Merchandise Authorization (RMA) acceptance from Intepro Systems.

2.2 User Preparation

In the beginning, the product must be connected to an appropriate power line input. Then, since fans intelligently cool it, it must be installed in sufficient space for circulation of air. It should be used in an area where the ambient temperature does not exceed 40°C.

2.3 Input Connection

The input terminals are located on the rear panel of the product (see Figure 2.1). The input power cord must be rated at least for 85°C. The input power cord must have rated current which is greater than or equal to the maximum input rated current of the product.

See Figure 2.1 and do the following procedures step by step:

1. Remove the safety cover from the rear panel of the product.
2. Screw the power cord to the input terminals of the product as follows,
 - 2.1 green or yellow wire to the terminal "G" of the input terminals;
 - 2.2 white or blue wire to the terminal "N" of the input terminals; and
 - 2.3 black or brown wire to the terminal "L" of the input terminals.
3. Slip the safety cover over the input terminals, and secure the cover with two screws.

WARNING

***Protective Grounding.* To protect users, the wire connected to terminal "G" (that is GND) must be connected to the earth ground. Under no circumstances shall this product operated without an adequate protective grounding connection.**

Installation of the power cord to the product must be done by a professional and in accordance with local electrical codes.

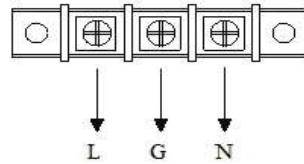

Figure 2.1 Input terminals

2.4 Output Connection

The output terminals are located on the rear panel of the product (see Figure 2.2). The terminals “N” and “L” of the output terminals are connected to the load. To match the safety requirements, the safety cover for the output terminals must be fastened. The wires to the load must be sufficiently large gauges, so they will not overheat while carrying the output current.

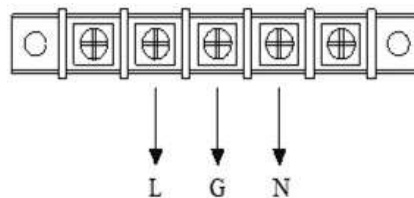

Figure 2.2 Output terminals

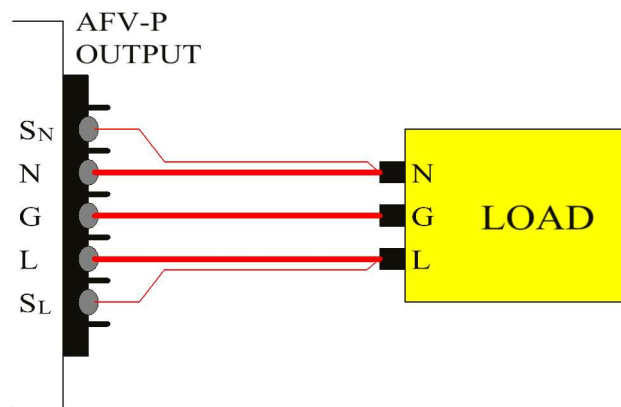

Figure 2.3 Output terminals to the load

NOTICE

When output voltage contains DC composition, Terminal “L” of the output terminals indicates the “+” terminal; terminal “N” of the output terminals indicates the “-” terminal.

2.5 Remote Sense Connection

The product supports remote sense function, which monitors the voltage at the load instead of the output terminal of the product. It ensures the delivery of accurate voltage as programmed at the load by automatically compensating the output voltage drop over the connecting cable.

Remove the iron chip from the terminals “S_N” and “S_L” of the remote sense connector, and connect the terminals of the remote sense connector to the corresponding terminal of the load. Because the sensing leads carry only a few millamperes, the sensing leads are much lighter than the load leads. The sensing leads are part of the feedback path of the product, so they must be kept at a low resistance in order to maintain the best performance. The sensing leads must be connected to the load carefully, so that they will not be open-circuited. If the sensing leads are left unconnected or become open-circuited during operation, the product will disable the output. The sensing leads must be a twisted pair to minimize the pickup of external noise. The sensing leads need to be connected to the load as close as possible.

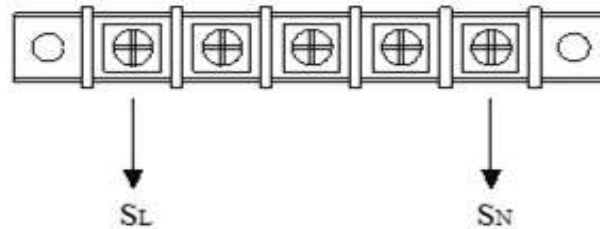

Figure 2.4 Remote sense connector

2.6 Power-on Procedures

WARNING

Before turning on the product, all protective grounding terminals, extension cords, and devices connected to the product must be connected to a protective ground. Any interruption of the protective ground will cause a potential shock hazard that could result in personal injury.

Apply power and press the power switch to turn on the product, then the touch screen located on the front panel will light up and display the POWER-ON page shown as below,



Figure 2.5 POWER-ON page

After displaying the POWER-ON page, the MAIN page is continuously shown on the touch screen as follows, and then users can input programming data or options by either manipulating the touch screen or turning the rotary knob.



Figure 2.6 MAIN page

2.7 Product Handle Installation

To install the handles to the right-side and the left-side of the product, please refer to the Figure 2.7 to fix the handles to the product with eight screws.

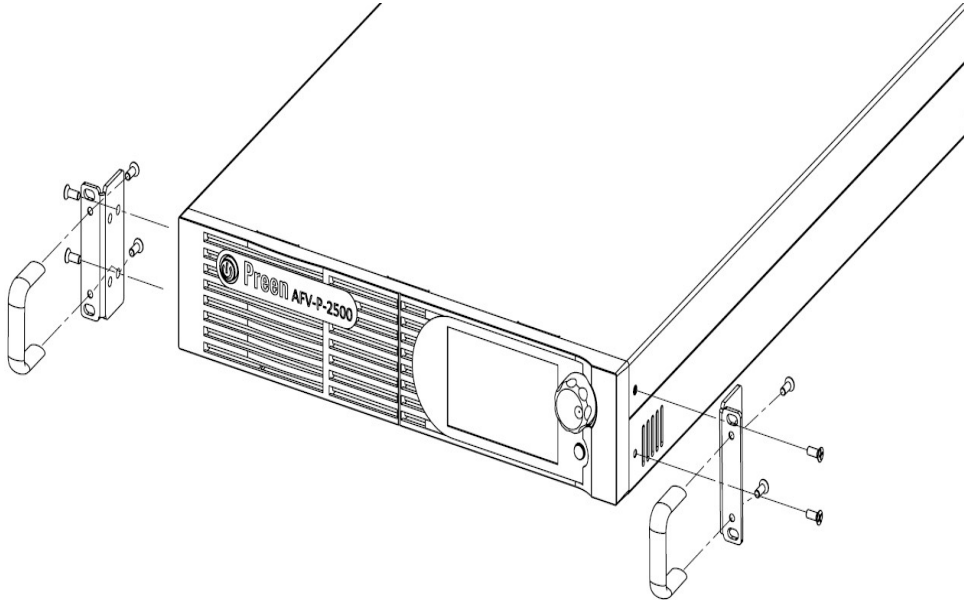

Figure 2.7 Product handle

2.8 Interface Card Installation

To install the interface card or replace the standard interface card with optional interface card, please refer to the Figure 2.8 to install or replace the interface card with two screws.

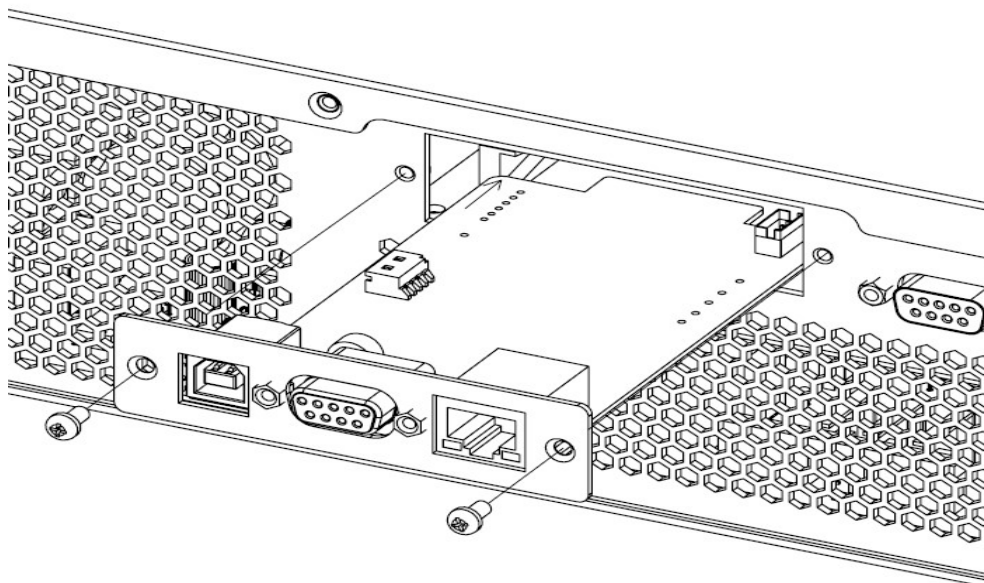

Figure 2.8 Interface Card

2.8.1 RS232/RS485 9-Pin D-Type Connector

To remotely control the product output via the interface RS232 or RS485, please connect a computer with the product via the RS232/RS485 9-pin D-type connector according to the following instructions.

The definition for the pins of the RS232/RS485 9-pin D-type female connector is given as follows:

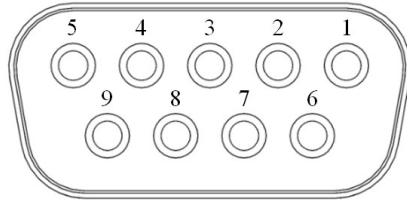

Figure 2.9 RS232/RS485 9-Pin D-Type female connector

Pin NO.	Definition
1	No Connection
2	RS232 TX
3	RS232 RX
4	No Connection
5	GND
6	No Connection
7	RS485 D+
8	RS485 D-
9	No Connection

2.8.2 PLC Remote Input Connector

AFV-P series provides PLC remote input interface for user to control the power supply output and select Memory Set #1 to #7. Please follow the tables provided below.

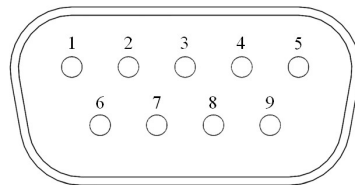
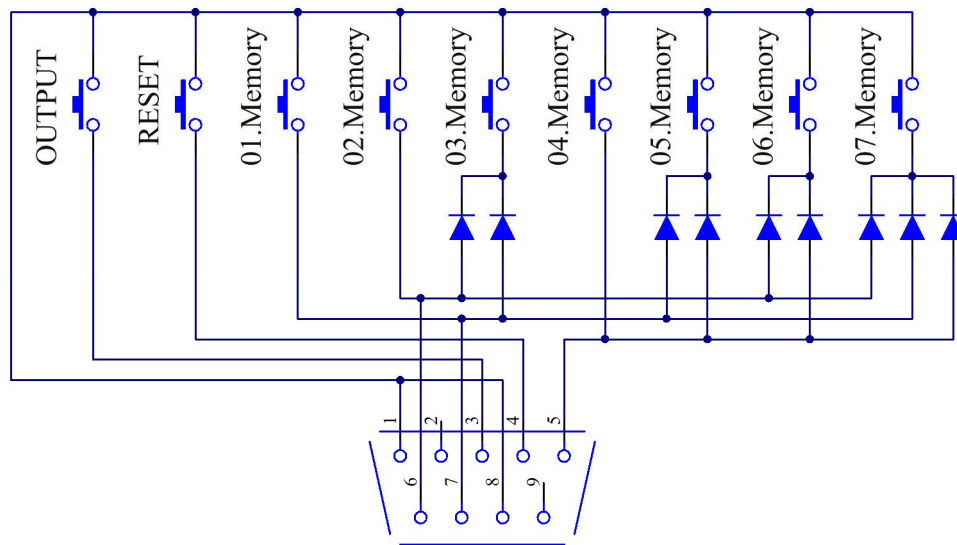

Figure 2.10 PLC remote input male connector

Condition	Pins	Relay State
Output ON	Connection between Pin3 and Pin8	Momentary contact closure
Reset/ Output OFF	Connection between Pin4 and Pin8	Momentary contact closure

Memory Set #	Pin5	Pin6	Pin7
Memory Set #1	OFF	OFF	ON
Memory Set #2	OFF	ON	OFF
Memory Set #3	OFF	ON	ON
Memory Set #4	ON	OFF	OFF
Memory Set #5	ON	OFF	ON
Memory Set #6	ON	ON	OFF
Memory Set #7	ON	ON	ON



2.8.3 PLC Remote Output Connector

AFV-P series provides PLC remote output interface for user to monitor the power supply's status via Pass, Fail, and Running conditions. Relays for the remote output are Normally Open, and the pins' specifications are AC 250V 1.0 Amp / DC 30V 0.5 Amp. The table below provides the conditions of pins and the relay states.

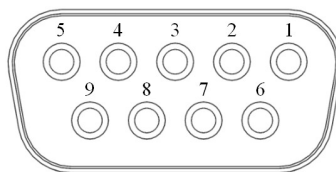

Figure 2.11 PLC remote output female connector

Condition	Pins	Relay State
Pass	Connection between Pin1 and Pin2	Closes on Pass and opens when executes Output ON or Reset/Output OFF

Fail	Connection between Pin3 and Pin4	Closes on Fail and opens when executes Output ON or Reset/Output OFF
Running	Connection between Pin5 and Pin6	Closes when output is on and closes when output is off

3 Local Operation

3.1 General

The product can support local operation or remote operation. The remote operation enabled via complete communication interfaces, such as RS232, RS485, Ethernet, USB or GPIB will be described in Chapter 8. In this section, the local operation enabled via the touch screen and the rotary knob on the front panel will be described. The product is configured for local operation when it is turned on.

3.2 Operation via the Touch Screen and the Rotary Knob

The product provides the user-friendly programming interface using the touch screen and rotary knob on the front panel for users. Each display of the touch screen on the product represents an operational page.

Before describing each operational page, the followings show how to use touch screen and rotary knob to input programming data or options. When the power-on procedures are finished (refer to Subsection 2.6), the touch screen will display the MAIN page subsequently.

A. Touch Screen

Press the item shown on the touch screen directly, so as to choose the desired item (see Figure 3.1). Use the virtual numeric and decimal keys to set value, and then

press the icon  on the touch screen to confirm. After setting value, users can



revise value by pressing the icon , or press the icon  to return to the previous page.



Figure 3.1 Press the desired item on the touch screen



Figure 3.2 Virtual numeric and decimal keys

B. Rotary Knob

Turn the rotary knob on the front panel to move the cursor shown on the touch screen, and press the rotary knob to choose the desired item. After choosing the desired item, continue to turn the rotary knob to set value, and then press the rotary knob to confirm.

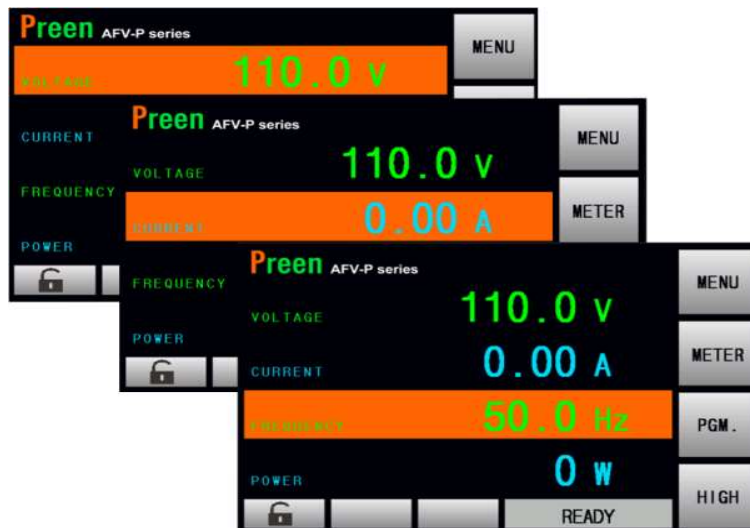

Figure 3.3 Move the cursor on the touch screen by turning the rotary knob

3.3 MAIN Page

When users turn on the product, the touch screen shows the MAIN page after the power-on procedures. The MAIN page shows the output settings and the measurement readings of the product output. Users can set output value by using the touch screen or the rotary knob (refer to Subsection 3.2), and then press the output & reset button on the front panel to enable the output of the product. Please see the following figures:















Figure 3.4 MAIN page when the product output is off





Figure 3.5 MAIN page when the product output is on

The description for the items and the icons on the MAIN page are given as follows:

- 1)  : Press to set the output voltage.
- 2)  : Press to set the maximum rated current.
- 3)  : Press to set the output frequency.
- 4)  : Press to set the maximum rated power.
- 5)  : Press to enter into the MENU page.

- 6)  : Press to enter into the METER page.
- 7)  : Press to enter into the PROGRAMMABLE page.
- 8)  /  : Press to set the output voltage range, with two options of HIGH and AUTO.
- 9)  /  : Shown the status of the output or the error code.
- 10)  : Press to lock/unlock the operation of the touch screen, and only allow pages to switch between the MAIN page and the METER page when the operation of the touch screen is locked.
- 11)  : Press to enter into the WAVE page.

NOTICE

When the product output is off, the upper-right side of the MAIN page will be the icon ; when the product output is on, the upper-right side of the MAIN page will be the icon .

3.3.1 Output Voltage Range

The product supplies full output voltage range with two options of HIGH and AUTO.



Users can press the icon  /  to set output voltage range at the MAIN page. HIGH indicates that the maximum output voltage will be 310V; AUTO indicates that the maximum output voltage switches automatically between 155V and 310V as required.



Figure 3.6 Set the output voltage range from HIGH to AUTO

3.4 MENU Page

If the MAIN page is shown on the touch screen, users can press the icon  to enter into the MENU page. Please see the following figures,

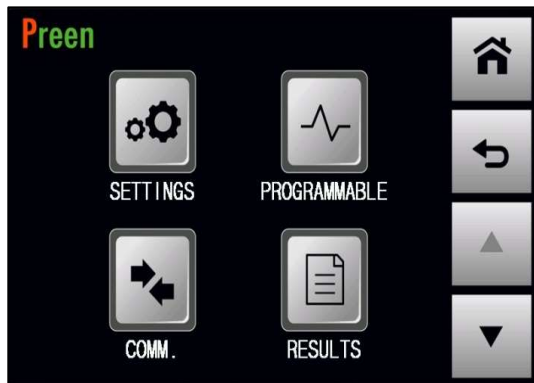

Figure 3.7 MENU page 1

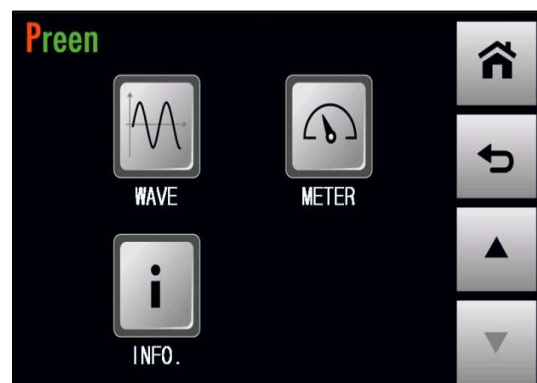













Figure 3.8 MENU page 2

The description for the icons at the MENU page is given as follows:

- 1)  : Press to enter into the SETTINGS page.
- 2)  : Press to enter into the PROGRAMMABLE page.
- 3)  : Press to enter into the COMMUNICATION page.
- 4)  : Press to enter into the RESULTS page.
- 5)  : Press to enter into the WAVE page.

- 6)  : Press to enter into the METER page.
- 7)  : Press to enter into the INFORMATION page.
- 8)  : Press to return to the MAIN page.
- 9)  : Press to return to the previous page.
- 10)  : Press to move to the previous page of the MENU page.
- 11)  : Press to move to the next page of the MENU page.

3.5 SETTINGS Page

If the MENU page is shown on the touch screen, users can press the icon  to enter into the SETTINGS page, and the SETTINGS page includes two subpages: the TESTING subpage and the SYSTEM subpage.

3.5.1 TESTING Subpage (ADVANCED Mode)

After pressing the icon  to enter into the SETTINGS page, the TESTING subpage at the ADVANCED mode will be shown on the touch screen in advance, and the ADVANCED mode is the default operational mode. Please see the following figures:

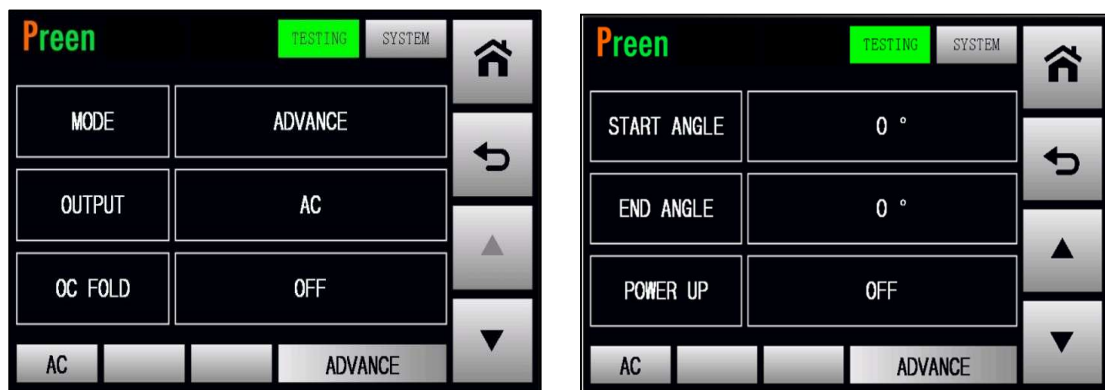

Figure 3.9 TESTING subpages 1 & 2 (ADVANCED mode)



Figure 3.10 TESTING subpage 3 & 4 (ADVANCED mode)

The description for the items and the icons at the TESTING subpage (ADVANCED mode) are given as follows:

- 1)

MODE	ADVANCE
------	---------

 : Press to set the operational mode, with two options of ADVANCE and BASIC.
- 2)

OUTPUT	AC
--------	----

 : Press to set the output mode, with two options of AC and DC.
- 3)

OC FOLD	OFF
---------	-----

 : Press to enable/disable the over current foldback, with two options of OFF and ON.
- 4)

START ANGLE	0 °
-------------	-----

 : Press to set the start angle, with options from 0° to 359°.
- 5)

END ANGLE	0 °
-----------	-----

 : Press to set the end angle, with options from 0° to 359°.
- 6)

POWER UP	OFF
----------	-----

 : Press to set the power-on status, with three options of OFF, ON and LAST.
- 7)







VOLTAGE SENSE	INT
---------------	-----

 : Press to set the voltmeter point, with two options of INT and EXT.
- 8)





FAIL STOP	OFF
-----------	-----

 : Press to enable/disable the fail stop feature, with two options of OFF and ON.

AFV-P Series User Manual

- 9)   : Press to enable/disable the consecutive step feature, with two options of ON and OFF.
- 10)   : Press to enable/disable the synchronized signal, with three options of EVENT, OFF and ON.
- 11)  : Press to move to the previous page of the TESTING subpage.
- 12)  : Press to move to the next page of the TESTING subpage.

NOTICE

The present operational mode can be seen on the lower-left side of the touch screen (that is, the icon  / ). Users can set the operational mode from the default **ADVANCED** mode to the **BASIC** mode by pressing the icon   twice at the **TESTING** subpage 1 on the touch screen. The detailed description of the **BASIC** mode will be given in Section 3.5.2.

3.5.1.1 Output Mode (AC or DC)

At the **TESTING** subpage 1 (**ADVANCED** mode), users are allowed to set the output mode with two options of **AC** and **DC**, so as to fit their application. Then, the **MAIN** page will change correspondingly according to the output mode.





Figure 3.11 MAIN page when the output mode is AC



Figure 3.12 MAIN page when the output mode is DC

The procedures of setting the output mode from AC to DC are given as below:

1. Press the item  twice to set the output mode from AC to DC.
2. Press the icon  to confirm.

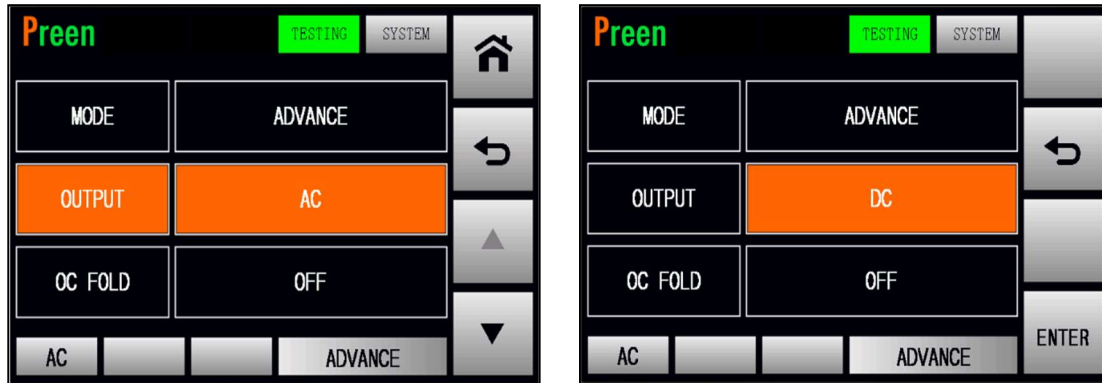



Figure 3.13 Set the output mode from AC to DC (ADVANCED mode)

3.5.1.2 Over Current Foldback

At the TESTING subpage 1 (ADVANCED mode), users are allowed to enable the over current foldback. When the output current exceeds the maximum rated current, and the over current foldback is enabled, the product can automatically control the output voltage to maintain the output current at the maximum rated current.

The procedures of enabling the over current foldback are given as below:

1. Press the item  twice to switch the icon status from OFF to ON.
2. Press the icon  to confirm and enable the over current foldback.

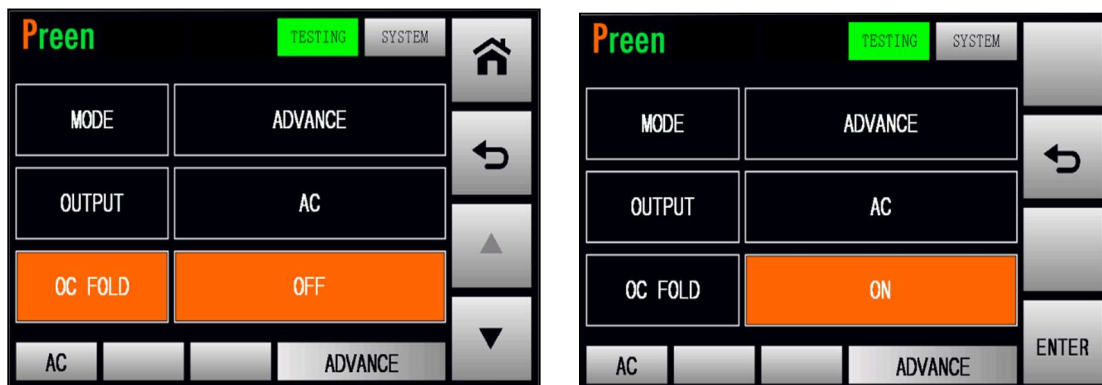

Figure 3.14 Enable the over current foldback (ADVANCED mode)

3.5.1.3 Output Phase Angle

At the TESTING subpage 2 (ADVANCED mode), users are allowed to set the output phase angel with options from 0° to 359° by using the touch screen and the rotary knob (refer to Subsection 3.2). In other words, the product can control the output phase angle (that is, the start angle and the end angle) of the output waveform.

Firstly, the procedures of setting the start angle from 0° to 90° by using the virtual numeric keys are given as below:





1. Press the item  to use the virtual numeric keys to set the value of 90.
2. Press the icon  to confirm.



Figure 3.15 Set the start angle from 0° to 90° (ADVANCED mode)

Secondly, the procedures of setting the end angle from 0° to 270° by using the virtual numeric keys are given as below:

1. Press the item  to use the virtual numeric keys to set the value of 270.
2. Press the icon  to confirm.

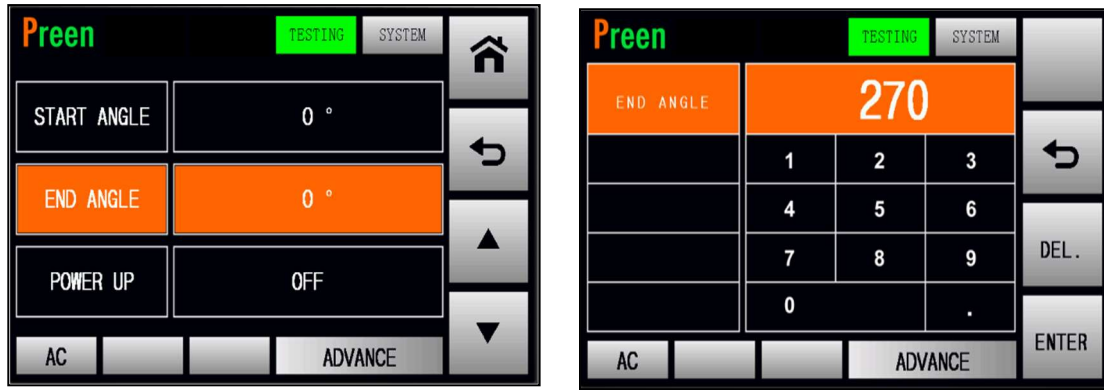



Figure 3.16 Set the end angle from 0° to 270° (ADVANCED mode)

3.5.1.4 Power-on Status

At the TESTING subpage 2 (ADVANCED mode), users are allowed to set the power-on status with three options of OFF, ON and LAST. OFF indicates that the output is off after turning on the product; ON indicates that the output is on after turning on the product; LAST indicates that if the output remains on while turning off the product previously, the output is on after turning on the product currently, otherwise, the output is off after turning on the product currently.

The procedures of setting the power-on status are given as below:

1. Press the item  repeatedly to switch the icon status from OFF to either ON or LAST.
2. Press the icon  to confirm.

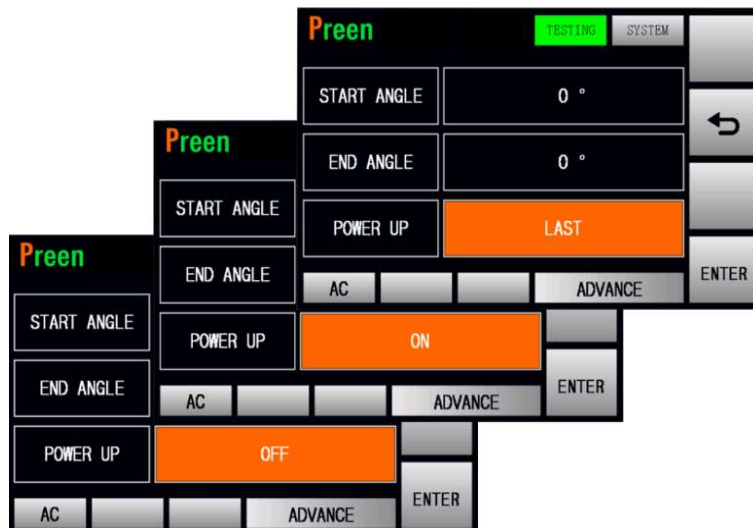

Figure 3.17 Three options of the power-on status (ADVANCED mode)

3.5.1.5 Synchronized Signal

At the TESTING subpage 4 (ADVANCED mode), users are allowed to enable the synchronized signal. There are three options of the synchronized signal: EVENT, OFF, and ON, and the default option is EVENT. EVENT indicates that the product outputs a 5V DC pulse signal when the product output changes; OFF indicates that the synchronized signal is disabled; ON indicates that the product continuously outputs a 5V DC signal when the product output is on, and stop the 5V DC signal when the product output is off.





Figure 3.18 Three options of the synchronized signal (ADVANCED mode)

3.5.1.6 Voltage Sense

There are two options for users to set the voltmeter point: INT and EXT, and the default option is INT. INT indicates that the voltmeter point is located at the terminals “N” and “L” of the output terminals of the product; EXT indicates that the voltmeter point is located at the terminals “S_N” and “S_L” of the output terminals.

The procedures of setting the voltmeter point from INT to EXT are given as below:

1. Press the item  twice to switch the icon status from INT to EXT.
2. Press the icon  to confirm.

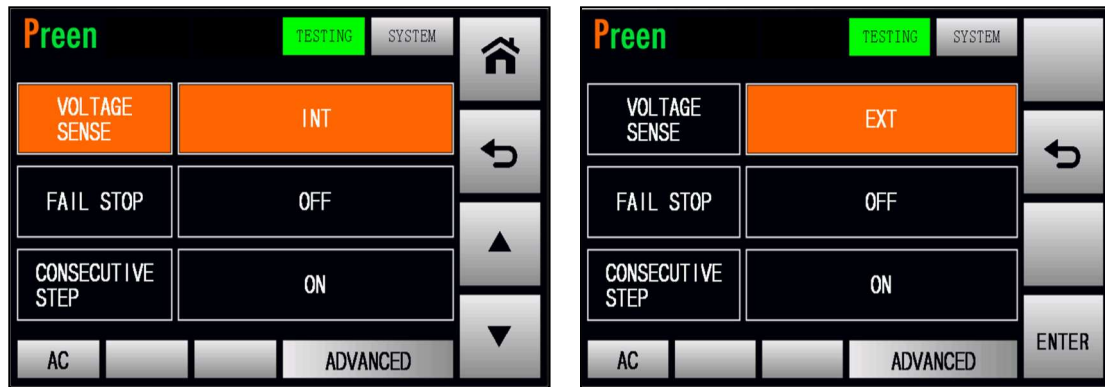

Figure 3.19 Set the voltmeter point from INT to EXT (ADVANCED mode)

NOTICE

When the voltmeter point is set to be EXT, but the terminals “S_L” and “S_N” are not connected to the load, the Low Voltage Protection (LVP) will be triggered after the output is on.

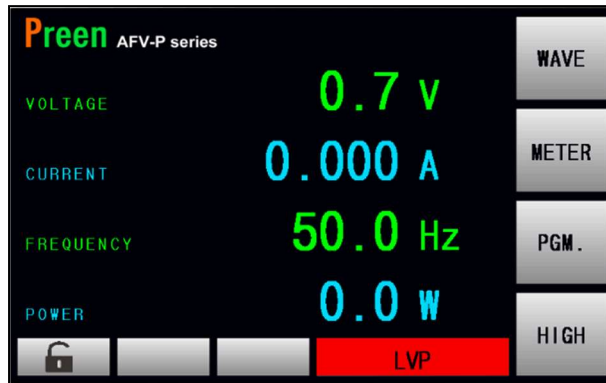

Figure 3.20 The MAIN page when LVP is triggered

3.5.1.7 Other Settings

At the TESTING subpage 3 (ADVANCED mode), users are allowed to enable the fail stop feature and the consecutive step feature.

A. Fail Stop Feature

There are two options of the fail stop feature: OFF and ON, and the default option is OFF. OFF indicates that the product will continue the output when the measurement readings exceed the rated values; ON indicates that the product will stop the output when the measurement readings exceed the rated values.

The procedures of enabling the fail stop are given as below:

1. Press the item  twice to switch the icon status from OFF to ON.

2. Press the icon  to confirm and enable the fail stop feature.



Figure 3.21 Enable the fail stop feature (ADVANCED mode)

B. Consecutive Step Feature

There are two options of the consecutive step feature: ON and OFF, and the default option is ON. ON indicates that each Step and Memory Set will be continuously performed without any HINT page when the PROGRAMMABLE feature is performed; OFF indicates that the HINT page will be displayed between each Step of the Memory Set for users to confirm when the PROGRAMMABLE feature is performed.

The procedures of disabling the consecutive step are given as below:

1. Press the item  twice to switch the icon status from ON to OFF.

2. Press the icon  to confirm and disable the consecutive step feature.



Figure 3.22 Disable the consecutive step feature (ADVANCED mode)



Figure 3.23 HINT page

3.5.2 TESTING Subpage (BASIC Mode)

If the operational mode is set to be the BASIC mode, the TESTING subpage at the BASIC mode will be shown on the touch screen after entering into the SETTINGS page. The manner of setting the operational mode can be referred to Section 3.5.1. Please see the following figures,



Figure 3.24 TESTING subpages 1 & 2 (BASIC mode)



Figure 3.25 TESTING subpages 3 & 4 (BASIC mode)

The description for the items and the icons at the TESTING subpage (BASIC mode) are given as follows,

- 1)

MODE	BASIC
------	-------

 : Press to set the operational mode, with two options of ADVANCE and BASIC.
- 2)

OUTPUT	AC
--------	----

 : Press to set the output mode, with two options of AC and DC.
- 3)

OC FOLD	OFF
---------	-----

 : Press to enable/disable the over current foldback, with two options of OFF and ON.
- 4)

START ANGLE	0 °
-------------	-----

 : Press to set the start angle, with options from 0° to 359°.

AFV-P Series User Manual

- 5)

END ANGLE	0 °
-----------	-----

 : Press to set the end angle, with options from 0° to 359°.
- 6)

POWER UP	OFF
----------	-----

 : Press to set the power-on status, with three options of OFF, ON and LAST.
- 7)

VOLTAGE SENSE	INT
---------------	-----

 : Press to set the voltmeter point, with two options of INT and EXT.
- 8)

VOLTAGE HI LIMIT	310.0 V
------------------	---------

 : Press to set the maximum rated voltage, with options from 0V to 310V.
- 9)

VOLTAGE LO LIMIT	0.0 V
------------------	-------

 : Press to set the minimum rated voltage, with options from 0V to 310V.
- 10)

SYNCHRONOUS SIGNAL	EVENT
--------------------	-------

 : Press to enable/disable the synchronized signal, with three options of EVENT, OFF and ON.
- 11)

FREQUENCY HI LIMIT	1000 Hz
--------------------	---------

 : Press to set the maximum rated frequency, with options from 40Hz to 500Hz (opt. from 15Hz to 1000Hz).
- 12)

FREQUENCY LO LIMIT	15.0 Hz
--------------------	---------

 : Press to set the minimum rated frequency, with options from 40Hz to 500Hz (opt. from 15Hz to 1000Hz).
- 13)

▲

 : Press to move to the previous page of the TESTING subpage.
- 14)

▼

 : Press to move to the next page of the TESTING subpage.

3.5.2.1 Output Mode (AC or DC)

There are two output mode of the product: AC and DC. Users can set the output mode at the TESTING subpage 1 (BASIC mode) to fit the product application. Then, the MAIN page will change correspondingly according to the output mode (see Figure 3.26).

The procedures of setting the output mode from AC to DC are given as below:



1. Press the item  twice to set the output mode from AC to DC.
2. Press the icon  to confirm.





Figure 3.26 Set the output mode from AC to DC (BASIC mode)

3.5.2.2 Over Current Foldback

At the TESTING subpage 1 (BASIC mode), users are allowed to enable the over current foldback. When the output current exceeds the maximum rated current, and the over current foldback is enabled, the product can automatically control the output voltage to maintain the output current at the maximum rated current.

The procedures of enabling the over current foldback are given as below:

1. Press the item  twice to switch the icon status from OFF to ON.
2. Press the icon  to confirm and enable the over current foldback.

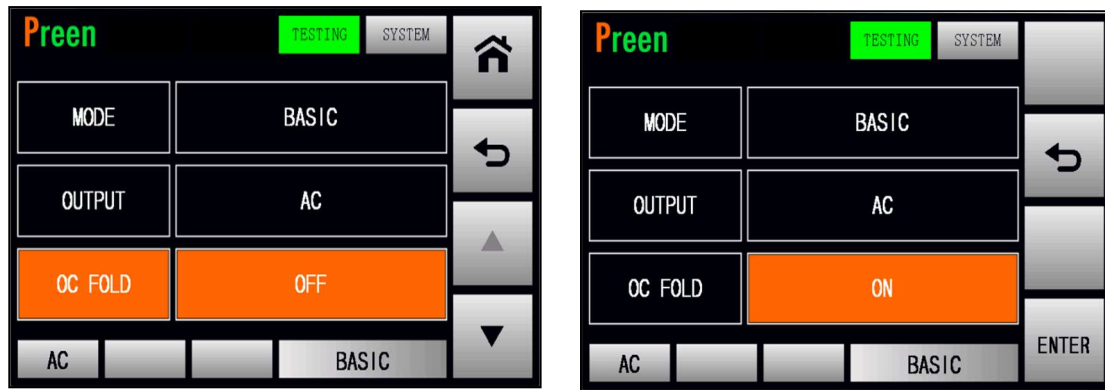

Figure 3.27 Enable the over current foldback (BASIC mode)

3.5.2.3 Output Phase Angle

At the TESTING subpage 2 (BASIC mode), users are allowed to set the output phase angle with options from 0° to 359° by using the touch screen and the rotary knob (refer to Subsection 3.2). The product can control the output phase angle (that is, the start angle and the end angle) of the output waveform.

Firstly, the procedures of setting the start angle from 0° to 90° by using the virtual numeric keys are given as below:



1. Press the item  to use the virtual numeric keys to set the value of 90.
2. Press the icon  to confirm.



Figure 3.28 Set the start angle from 0° to 90° (BASIC mode)

Secondly, the procedures of setting the end angle from 0° to 270° by using the virtual numeric keys are given as below:

1. Press the item  to use the virtual numeric keys to set

the value of 270.

2. Press the icon  to confirm.





Figure 3.29 Set the end angle from 0° to 270° (BASIC mode)

3.5.2.4 Power-on Status

At the TESTING subpage 2 (BASIC mode), users are allowed to set the power-on status with three options of OFF, ON and LAST. OFF indicates that the output is off after turning on the product; ON indicates that the output is on after turning on the product; LAST indicates that if the output remains on while turning off the product previously, the output is on after turning on the product currently, otherwise, the output is off after turning on the product currently.

The procedures of setting the power-on status are given as below:

1. Press the item   repeatedly to switch the icon status from OFF to either ON or LAST.
2. Press the icon  to confirm.

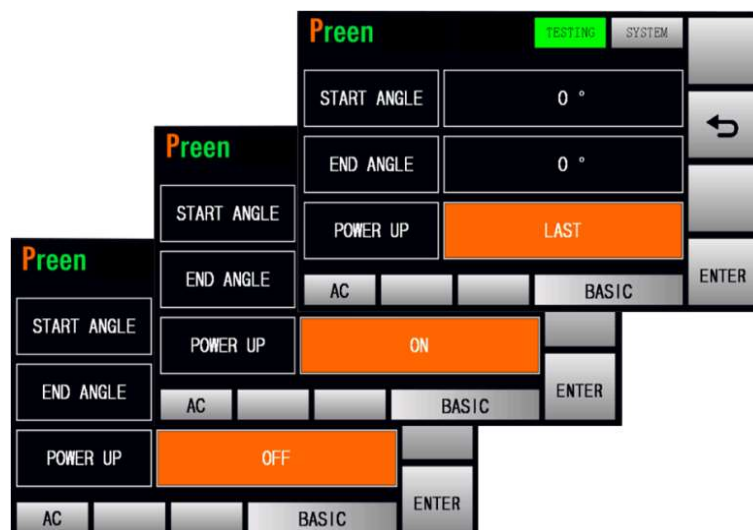

Figure 3.30 Three options of the power-on status (BASIC mode)

3.5.2.5 Rated Voltage

At the TESTING subpage 3 (BASIC mode), users are allowed to set the rated voltage with options from 0V to 310V by using the touch screen and the rotary knob (refer to Subsection 3.2). When users set value of the output voltage exceeding the rated voltage (that is, the maximum rated voltage and the minimum rated voltage), the product can automatically control the setting value of the output voltage to maintain the output voltage at the rated voltage.

3.5.2.6 Rated Frequency

At the TESTING subpage 4 (BASIC mode), users are allowed to set the rated frequency with options from 40Hz to 500Hz (opt. from 15Hz to 1000Hz) by using the touch screen and the rotary knob (refer to Subsection 3.2). When users set value of the output frequency exceeding the rated frequency (that is, the maximum rated frequency and the minimum rated frequency), the product can automatically control the setting value of the output frequency to maintain the output frequency at the rated frequency.

3.5.2.7 Synchronized Signal

At the TESTING subpage 4 (BASIC mode), users are allowed to enable the synchronized signal with three options of EVENT, OFF and ON, and the default option is EVENT. EVENT indicates that the product outputs a 5V DC pulse signal when the product output changes; OFF indicates that the synchronized signal is disabled; ON indicates that the product continuously outputs a 5V DC signal when the product output is on, and stop the 5V DC signal when the product output is off.



Figure 3.31 Three options of the synchronized signal (BASIC mode)

3.5.2.8 Voltage Sense

At the TESTING subpage 3 (BASIC mode), users are allowed to set the voltmeter point with two options of INT and EXT, and the default option is INT. INT indicates that the voltmeter point is located at the terminals “N” and “L” of the output terminals of the product; EXT indicates that the voltmeter point is located at the terminals “S_N” and “S_L” of the output terminals.

The procedures of setting the voltmeter point from INT to EXT are given as below:

1. Press the item  twice to switch the icon status from INT to EXT.

2. Press the icon  to confirm.

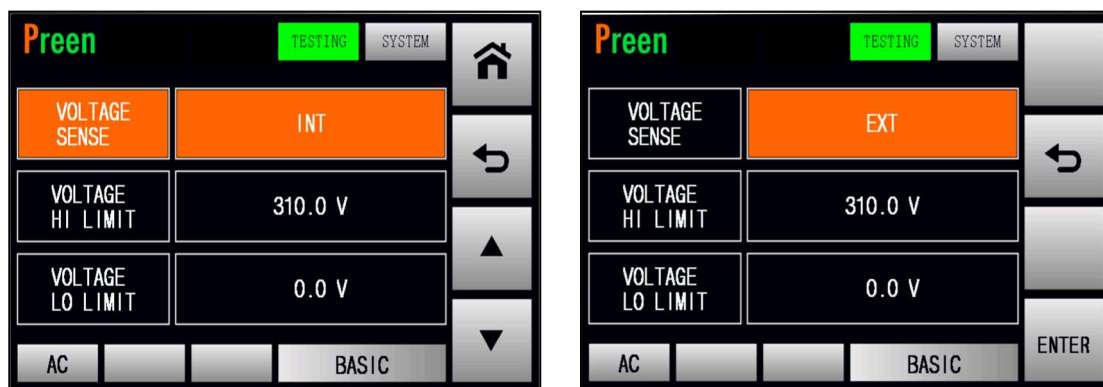

Figure 3.32 Set the voltmeter point from INT to EXT (BASIC mode)

NOTICE

When the voltmeter point is set to be EXT, but the terminals “S_L” and “S_N” are not connected to the load, the Low Voltage Protection (LVP) will be triggered after the output is on.

3.5.3 SYSTEM Subpage



After pressing the icon  to enter into the SETTINGS page, the TESTING subpage will be shown on the touch screen, and users can press the icon  on the upper-right side of the touch screen to enter into the SYSTEM subpage. Please see the following figures,









Figure 3.33 SYSTEM subpages 1 & 2





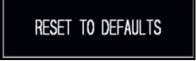
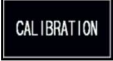





Figure 3.34 SYSTEM subpage 3

The description for the items and the icons at the SYSTEM subpage are given as follows,

- 1)   : Press to set the operational language, with four options of ENGLISH, 繁體中文, 简体中文 and 日本語.
- 2)   : Press to set the alarm volume, with options from 0 to 9.
- 3)   : Press to set the backlight level of the touch screen, with options from 0 to 9.

AFV-P Series User Manual

- 4)   : Press to set the RESULTS feature, with three options of LAST, ALL and P/F.
- 5)   : Press to unlock/lock the PROGRAMMABLE feature, with two options of OFF and ON.
- 6)   : Press to reset the product to the default settings.
- 7)   : Press to enter into the CALIBRATION page (refer to Section 4).
- 8)  : Press to move to the previous page of the SYSTEM subpage.
- 9)  : Press to move to the next page of the SYSTEM subpage.

3.5.3.1 Operational Language

At the SYSTEM subpage 1, users are allowed to set the operational language with four options of ENGLISH, 繁體中文, 简体中文 and 日本語, and the default operational language is ENGLISH. ENGLISH indicates English; 繁體中文 indicates Traditional Chinese; 简体中文 indicates Simplified Chinese; 日本語 indicates Japanese. The procedures of setting the operational language are given as below:

1. Press the item

LANGUAGE	ENGLISH
----------	---------

 repeatedly to switch the icon status to the desired language.
2. Press the icon

ENTER

 to confirm.



Figure 3.35 Four options of the operational language

3.5.3.2 Alarm Volume

At the SYSTEM subpage 1, users are allowed to set the alarm volume with options from 0 to 9 by using the touch screen and the rotary knob (refer to Subsection 3.2), and the default alarm volume is 5. The bigger the number is, the higher the alarm volume is.

The procedures of setting the alarm volume from 5 to 9 by using the touch screen are given as below:

1. Press the item

ALARM	5
-------	---

 to use the virtual numeric keys to set the value of 9.
2. Press the icon

ENTER

 to confirm.



Figure 3.36 Set the alarm volume from 5 to 9

3.5.3.3 Backlight Level

At the SYSTEM subpage 1, users are allowed to set the backlight level of the touch screen with options from 0 to 9 by using the touch screen and the rotary knob (refer to Subsection 3.2), and the default backlight level is 9. The bigger the number is, the brighter the touch screen is.

The procedures of setting the backlight level from 9 to 5 by using the touch screen are given as below:

1. Press the item

BACKLIGHT	9
-----------	---

 to use the virtual numeric keys to set the value of 5.
2. Press the icon

ENTER

 to confirm.



Figure 3.37 Set the backlight level from 9 to 5

3.5.3.4 RESULTS Feature

At the SYSTEM subpage 2, users are allowed to set the RESULTS feature with three options of LAST, ALL and P/F, and the default option is LAST. LAST indicates that the product will only display the result of the last Step Loop at the RESULTS page after performing the PROGRAMMABLE feature; ALL indicates that the product will display each Step Loop at the RESULTS page after performing the PROGRAMMABLE feature;

P/F indicates that the product will display whether each Step Loop is pass the output test or not at the RESULTS page after performing the PROGRAMMABLE feature (refer to Subsection 3.5.5).

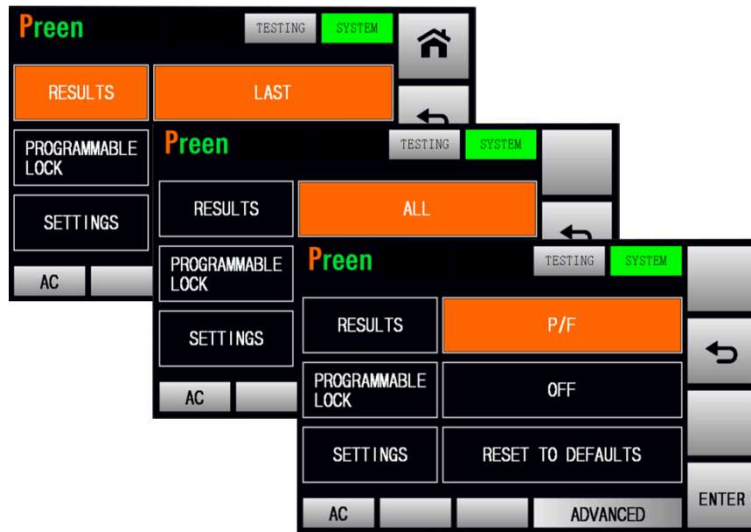

Figure 3.38 Three options of the RESULTS feature.

3.5.3.5 Other Settings

A. Unlock/Lock the PROGRAMMABLE Feature

At the SYSTEM subpage 2, users are allowed to unlock/lock the PROGRAMMABLE feature of the product with two options of OFF and ON, and the default option is OFF. The procedures of locking the PROGRAMMABLE feature are given as below:

1. Press the item  twice to switch the icon status from OFF to ON.

2. Press the icon  to confirm and lock the PROGRAMMABLE feature.



Figure 3.39 Lock the PROGRAMMABLE feature.

B. Reset to the Default Settings

At the SYSTEM subpage 2, users are allowed to reset the product to the default settings. The procedures of resetting the product to the default setting are given as below:

1. Press the item  twice to switch the icon status to YES.



2. Press the icon  to confirm and reset the product.



Figure 3.40 Reset the product to the default settings

3.6 COMMUNICATION Page

If the MENU page is shown on the touch screen, users can press the icon  to enter into the COMMUNICATION page, and the COMMUNICATION page includes two subpages: the ETHERNET subpage and the GENERAL subpage.

3.6.1 ETHERNET Subpage



After pressing the icon  to enter into the COMMUNICATION page, the ETHERNET subpage will be shown on the touch screen in advance. Please see the following figures,



Figure 3.41 ETHERNET subpages 1 & 2

The description for the items and the icons at the ETHERNET subpage are given as follows,

- 1)  : Press to set the IP mode with two options of AUTO mode and MANUAL mode.
- 2)  : Press to set the IP address under the MANUAL mode.
- 3)  : Press to set the subnet mask under the MANUAL mode.
- 4)  : Press to set the default gateway under the MANUAL mode.

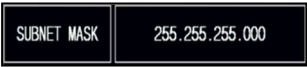
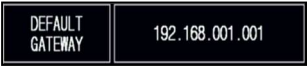
- 5)

MAC ADDRESS	D8-FC-94-25-87
-------------	----------------

 : Press to set the MAC address under the MANUAL mode.
- 6)

PORT	1300
------	------

 : Press to set the Ethernet port under the MANUAL mode.
- 7)

▲

 : Press to move to the previous page of the ETHERNET subpage.
- 8)

▼

 : Press to move to the next page of the ETHERNET subpage.

3.6.2 GENERAL Subpage

After pressing the icon  to enter into the COMMUNICATION page, the ETHERNET subpage will be shown on the touch screen in advance, and users can press the icon

GENERAL

 on the upper-right side of the touch screen to enter into the GENERAL subpage. Please see the following figures,



Figure 3.42 GENERAL subpages 1 & 2

The description for the items and the icons at the GENERAL subpage are given as follows,

- 1)

PLC REMOTE	OFF
------------	-----

 : Press to enable/disable the PLC remote feature.
- 2)

COMMAND FORMAT	SCPI
----------------	------

 : Press to set the command format, with two options of MODBUS and SCPI.
- 3)

MODBUS ID	1
-----------	---

 : Press to set the Modbus ID, with options from 1 to

255.

- 4)

BAUD RATE	115200bps
-----------	-----------

 : Press to set the Baud rate, with five options of 9600bps, 19200bps, 38400bps, 57600bps and 115200bps.

- 5)

▲

 : Press to move to the previous page of the GENERAL subpage.

- 6)

▼

 : Press to move to the next page of the GENERAL subpage.

3.6.3 GENERAL Subpage with GPIB interface (optional)

After replacing the standard interface card with the optional GPIB interface card (refer to Subsection 2.8), the GENERAL subpage with the GPIB interface will be shown on the touch screen. Please see the following figure,



Figure 3.43 GENERAL subpage with the GPIB interface

The description for the items at the GENERAL subpage with GPIB interface are given as follows,

- 1)

PLC REMOTE	OFF
------------	-----

 : Press to enable/disable the PLC remote feature.

- 2)

GPIB ADDRESS	5
--------------	---

 : Press to set the GPIB address.

3.7 RESULTS Page

If the MENU page is shown on the touch screen, users can press the icon  to enter into the RESULTS page. Please see the following figures,

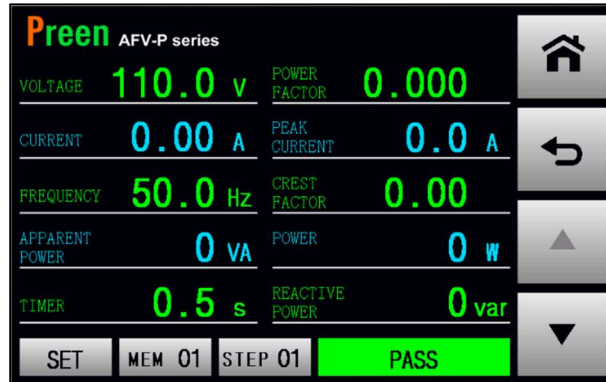



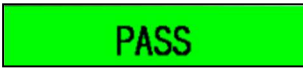





Figure 3.44 RESULTS page

The description for the icons at the RESULTS page are given as follows,

- 1)  : Press to see the settings of the desired Step of the Memory Set.
- 2)  : Show the label number of the current Memory Set.
- 3)  : Show the label number of the current Step.
- 4)  : Show whether the desired Step of the Memory Set is pass the output test or not.
- 5)  : Press to select the previous Step of the Memory Set.
- 6)  : Press to select the next Step of the Memory Set.

3.8 WAVE Page

If the MENU page is shown on the touch screen, users can press the icon  to enter into the WAVE page. Please see the following figures,

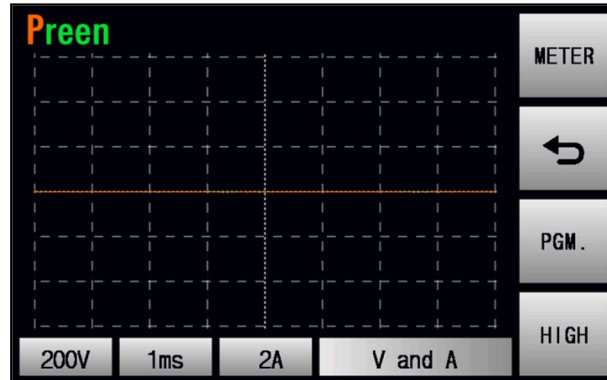

Figure 3.45 WAVE page when the product output is off

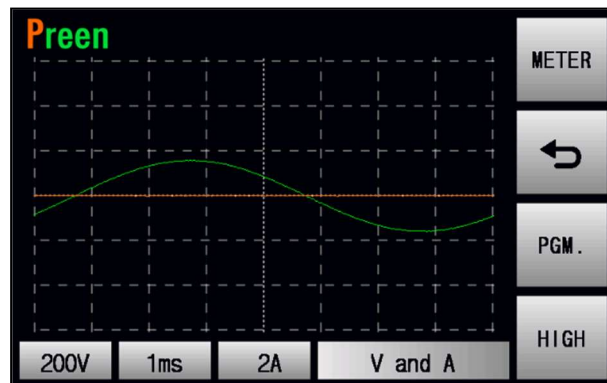

Figure 3.46 WAVE page when the product output is on





Additionally, when the product output is on, users can also press the icon  located the upper-right side of the MAIN page to enter into the WAVE page.



Figure 3.47 MAIN page when the product output is on

The description for the icons at the WAVE page are given as follows,

- 1)  : Press to set the displaying scale of the output voltage, with two options of 40V and 200V per division.
- 2)  : Press to set the display scale of the time, with six options of 1ms, 2ms, 4ms, 10ms, 100 μ s, 200 μ s and 400 μ s per division.
- 3)  : Press to set the display scale of the output current, with two options of 2A and 20A per division for the product models of AFV-P-600 and AFV-P-1250; 4A and 40A per division for the product model of AFV-P-2500; 8A and 80A per division for the product model of AFV-P-5000.
- 4)  : Press to set the waveform displayed at the WAVE page, with options of merely displaying the output voltage, merely displaying the output current and displaying both of the above. The waveform of the output voltage is shown in green; the waveform of the output current is shown in orange.

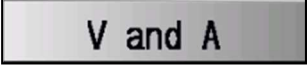
3.9 METER Page

If the MENU page is shown on the touch screen, users can press the icon  to enter into the METER page. Please see the following figures,



Figure 3.48 METER page when the product output is on

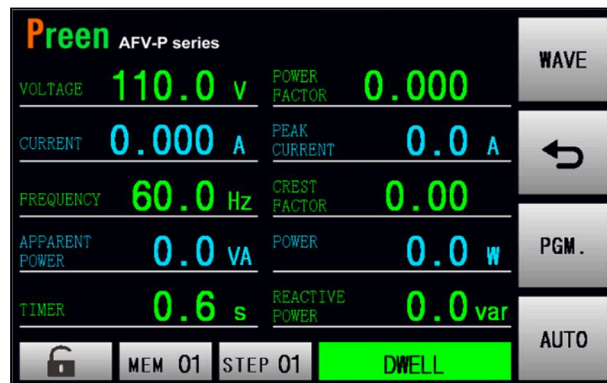

Figure 3.49 METER page when the PROGRAMMABLE feature is performed

Additionally, when the MAIN page is shown on the touch screen, users can also press













the icon  at the MAIN page to enter into the METER page.

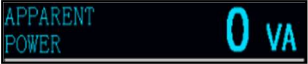

Figure 3.50 MAIN page

The description for the items and the icons at the METER page are given as follows,

- 1)  : Show the measurement reading of the output voltage.
- 2)  : Show the measurement reading of the output current.
- 3)  : Show the measurement reading of the output frequency.
- 4)  : Show the measurement reading of the apparent power.
- 5)  : Show the measurement reading of the power factor.
- 6)  : Show the measurement reading of the peak current.
- 7)  : Show the measurement reading of the crest factor.
- 8)  : Show the measurement reading of the output power.
- 9)  : Show the measurement reading of the reactive power.
- 10)  : Show the elapsed time of the product output.
- 11)  : Show the label number of the current Memory Set.
- 12)  : Show the label number of the current Step.

3.10 INFORMATION Page









If the MENU page is shown on the touch screen, users can press the icon  to enter into the INFORMATION page. Please see the following figures:



Figure 3.51 INFORMATION page

The description for the items at the INFORMATION page are given as follows:

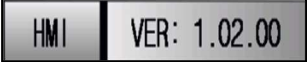
- 1)  : Show the producer of the product.
- 2)  : Show the product model.
- 3)  : Show the serial number of the product.
- 4)  : Show the firmware version of the product
- 5)  : Show the firmware version of the Ethernet card.
- 6)  : Show the HMI firmware version of the product.
- 7)  : Press to move to the previous page of the INFORMATION page.
- 8)  : Press to move to the next page of the INFORMATION page.

3.11 Protection

The product provides complete protection for OVP, LVP, OCP, OPP, OTP, RCP, Fan Fail and AMP Fail. When the protection is triggered, the product will immediately stop the product output, and show the error code corresponding to the protection condition on the touch screen.

Please notice that if any protection is triggered, users shall eliminate the cause of the protection condition according to the Table 3-11-1 before resuming the product output. After eliminating the cause of the protection condition, users can press the output & reset button on the front panel to unlock the protection, so as to resume the product output.

Error code, possible causes and solution corresponding to the protection condition are listed as below:

Error Code	Protection Condition	Possible Cause	Possible Solution
OVP	Over Voltage Protection	<ol style="list-style-type: none"> 1. Load oscillation. 2. Problem of the voltage feedbacking from the load to the inverter circuitries. 3. Fault of the inverter control circuitries. 	<ol style="list-style-type: none"> 1. Remove the load to inspect the output voltage. 2. Seek the technical assistance.
LVP	Low Voltage Protection	<ol style="list-style-type: none"> 1. Load oscillation. 2. Incorrect wiring of the terminals S_L and S_N when setting voltmeter point to EXT. 3. Fault of the inverter control circuitries. 	<ol style="list-style-type: none"> 1. Remove the load to inspect the output voltage. 2. Inspect the wiring of the terminals S_L and S_N. 3. Seek the technical assistance.
OCP	Over Current Protection	When the output current exceeds the maximum rated current.	<ol style="list-style-type: none"> 1. Decrease the output voltage to fit the maximum rated current 2. Remove the load to inspect the output current
OPP	Over Power Protection	When the output power exceed the maximum rated power.	<ol style="list-style-type: none"> 1. Decrease the output voltage to fit the maximum rated power. 2. Remove the load to inspect the output power.
OTP	Over Temperature	1. Poor ventilation.	1. Provide adequate space

	Protection	2. High environmental temperature.	for product ventilation 2. Use the vacuum cleaner to clean the air inlet 3. Install the product on the place with environmental temperature not exceeding 40°C.
RCP	Reverse Current Protection	Problems of the current feedbacking from the load to the inverter circuitries.	Remove the load to inspect the output voltage.
Fan Fail	Fan Failure	Fault of the fan.	Seek the technical assistance.
AMP Fail	Inverter Failure	1. Load oscillation 2. Problems of the voltage feedbacking to the inverter circuitries 3. Fault of the inverter circuitries.	1. Remove the load to inspect the output voltage. 2. Seek the technical assistance.

Table 3.1 Troubleshooting Table

4 Calibration

The product provides a simple way to calibrate the product output and measurement accuracy without opening cover. Users can perform the calibration according to the procedures given as follows step by step. A voltage meter, a current meter and suitable load are needed while performing the calibration procedures. Connections for the instruments mentioned above please refer to Figure 4.1.

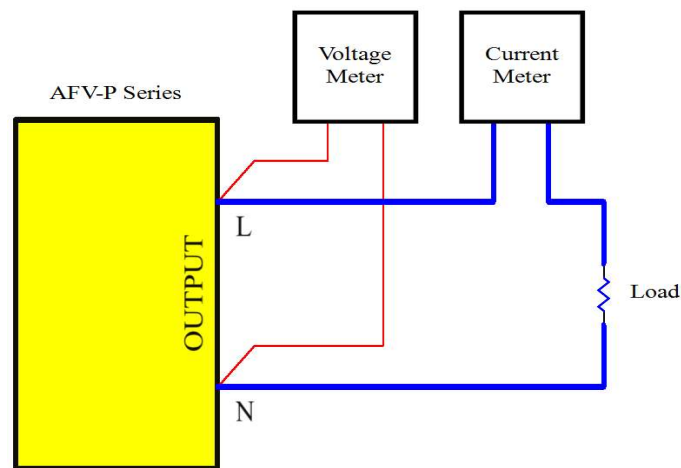

Figure 4.1 Instrument connection for calibration

At the SYSTEM subpage 3 of the SETTINGS page, users can press the item

CALIBRATION	****
-------------	------

, and then use the virtual numeric keys to set the value of 8888, so as to enter into the CALIBRATION page. Please see the following figures,



Figure 4.2 Enter into the CALIBRATION page from the SYSTEM subpage 3



Figure 4.3 CALIBRATION pages 1 & 2

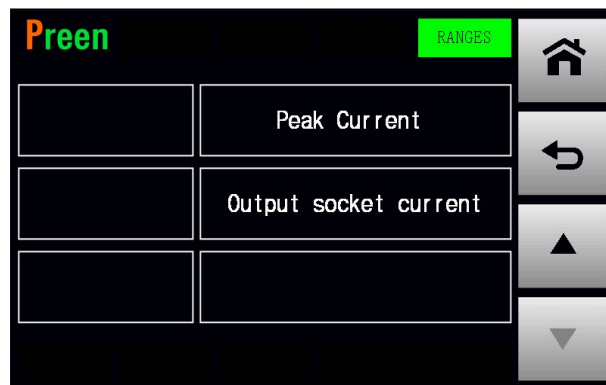





Figure 4.4 CALIBRATION page 3

The description for the items at the CALIBRATION page are given as follows,

- 1) HI-Range voltage 310V : Press to enter into the page which calibrates the HI-Range voltage 310V.
- 2) LO-Range voltage 155V : Press to enter into the page which calibrates the LO-Range voltage 155V.
- 3) HI-Range voltage 60V : Press to enter into the page which calibrates the HI-Range voltage 60V.
- 4) LO-Range voltage 60V : Press to enter into the page which calibrates the LO-Range voltage 60V.
- 5) HI-Range RMS current : Press to enter into the page which calibrates the HI-Range RMS current.
- 6) LO-Range RMS current : Press to enter into the page which calibrates the

LO-Range RMS current.

- 7)  : Press to enter into the page which calibrates the peak current.
- 8)  : Press to enter into the page which calibrate the output socket current (specialize for the product model of AFV-P-5000).
- 9)  : Press to move to the previous page of the CALIBRATION page.
- 10)  : Press to move to the next page of the CALIBRATION page.

4.1 HI-Range Voltage 310V

At the CALIBRATION page 1, users are allowed to enter into the page which calibrates the HI-Range voltage 310V. The procedures of calibrating the HI-Range voltage 310V are given as below:

1. Press the item  repeatedly to enter into the page which calibrates the HI-Range voltage 310V (refer to Figure 4.5).
2. Connect the product with the voltage meter (refer to Figure 4.1).
3. Press the output & reset button on the front panel to enable the calibration of the HI-Range voltage 310V (refer to Figure 4.6), and then the product will start to output the voltage which is closed to 310V.
4. Use the rotary knob to adjust the product output until the measurement reading of the output voltage shown on the touch screen is closed to the measurement reading shown on the voltage meter.
5. Press the rotary knob to confirm and finish the calibration.

NOTICE

Before calibrating the HI-Range voltage 310V, the load shall be temporarily removed from the product to avoid a potential electric shock.

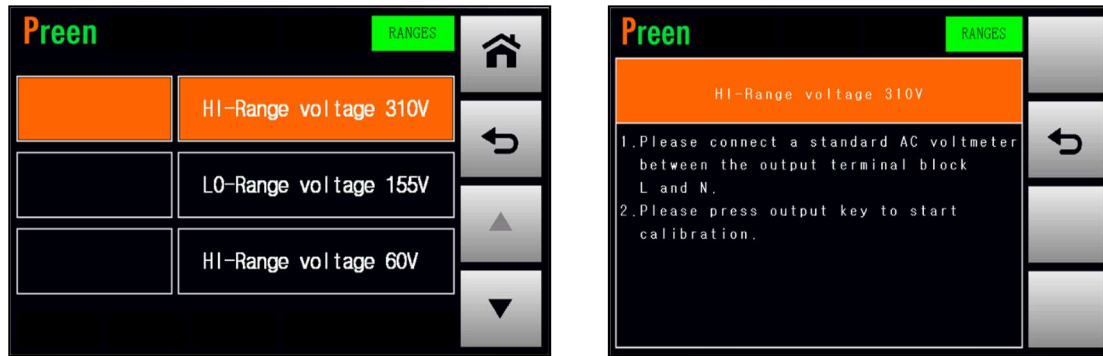

Figure 4.5 Enter into the page which calibrates the HI-Range voltage 310V



Figure 4.6 Enable the calibration of the HI-Range voltage 310V

4.2 LO-Range Voltage 155V

At the CALIBRATION page 1, users are allowed to enter into the page which calibrates the LO-Range voltage 155V. The procedures of calibrating the LO-Range voltage 155V are given as below:

1. Press the item LO-Range voltage 155V repeatedly to enter into the page which calibrates the LO-Range voltage 155V (refer to Figure 4.7).
2. Connect the product with the voltage meter (refer to Figure 4.1).
3. Press the output & reset button on the front panel to enable the calibration of the LO-Range voltage 155V (refer to Figure 4.8), and then the product will start to output the voltage which is closed to 155V.
4. Use the rotary knob to adjust the product output until the measurement reading of the output voltage shown on the touch screen is closed to the measurement reading shown on the voltage meter.
5. Press the rotary knob to confirm and finish the calibration.

NOTICE

Before calibrating the LO-Range voltage 155V, the load shall be temporarily removed from the product to avoid a potential electric shock.



Figure 4.7 Enter into the page which calibrates the LO-Range voltage 155V

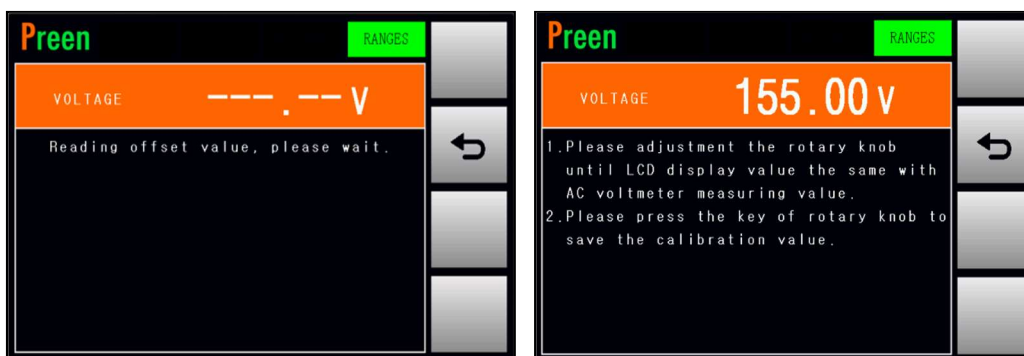

Figure 4.8 Enable the calibration of the LO-Range voltage 155V

4.3 HI-Range Voltage 60V

At the CALIBRATION page 1, users are allowed to enter into the page which calibrates the HI-Range voltage 60V. The procedures of calibrating the HI-Range voltage 60V are given as below:

1. Press the item HI-Range voltage 60V repeatedly to enter into the page which calibrates the HI-Range voltage 60V (refer to Figure 4.9).
2. Connect the product with the voltage meter (refer to Figure 4.1)
3. Press the output & reset button on the front panel to enable the calibration of the HI-Range voltage 60V (refer to Figure 4.10), and then the product will start to output the voltage which is closed to 60V.
4. Use the rotary knob to adjust the product output until the measurement reading of the output voltage shown on the touch screen is closed to the measurement reading shown on the voltage meter.
5. Press the rotary knob to confirm and finish the calibration.

NOTICE

Before calibrating the HI-Range voltage 60V, the load shall be temporarily removed from the product to avoid a potential electric shock.



Figure 4.9 Enter into the page which calibrates the HI-Range voltage 60V



Figure 4.10 Enable the calibration of the HI-Range voltage 60V

4.4 LO-Range Voltage 60V

At the CALIBRATION page 2, users are allowed to enter into the page which calibrates the LO-Range voltage 60V. The procedures of calibrating the LO-Range voltage 60V are given as below:

1. Press the item LO-Range voltage 60V repeatedly to enter into the page which calibrates the LO-Range voltage 60V (refer to Figure 4.11).
2. Connect the product with the voltage meter (refer to Figure 4.1)
3. Press the output & reset button on the front panel to enable the calibration of the LO-Range voltage 60V (refer to Figure 4.12), and then the product will start to output the voltage which is closed to 60V.
4. Use the rotary knob to adjust the product output until the measurement reading of the output voltage shown on the touch screen is closed to the measurement reading shown on the voltage meter.
5. Press the rotary knob to confirm and finish the calibration.

NOTICE

Before calibrating the LO-Range voltage 60V, the load shall be temporarily removed from the product to avoid a potential electric shock.



Figure 4.11 Enter into the page which calibrates the LO-Range voltage 60V

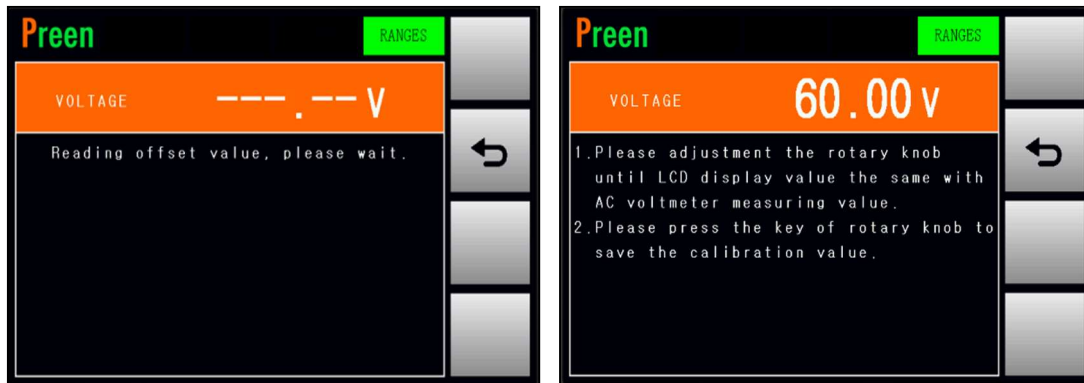

Figure 4.12 Enable the calibration of the LO-Range voltage 60V

4.5 HI-Range RMS Current

At the CALIBRATION page 2, users are allowed to enter into the page which calibrates the HI-Range RMS current. The procedures of calibrating the HI-Range RMS current are given as below:

HI-Range RMS current

1. Press the item HI-Range RMS current repeatedly to enter into the page which calibrates the HI-Range RMS current (refer to Figure 4.13).
2. Connect the product with the current meter and suitable load (refer to Figure 4.1).
3. Press the output & reset button on the front panel to enable the calibration of the HI-Range RMS current (refer to Figure 4.14), and then the product will start to output the voltage which is closed to 100V.
4. Use the rotary knob to adjust the product output until the measurement reading of the output current shown on the touch screen is closed to the measurement reading shown on the current meter.
5. Press the rotary knob to confirm and finish the calibration.

NOTICE		
<p>The definition of the suitable load for calibrating the HI-Range RMS current are given as follows, and the suitable load shall be resistive load.</p>		
Model	Resistive Value	Rated Power
AFV-P-600	20Ω	500W
AFV-P-1250	10Ω	1000W
AFV-P-2500	5Ω	2000W
AFV-P-5000	2.5Ω	4000W

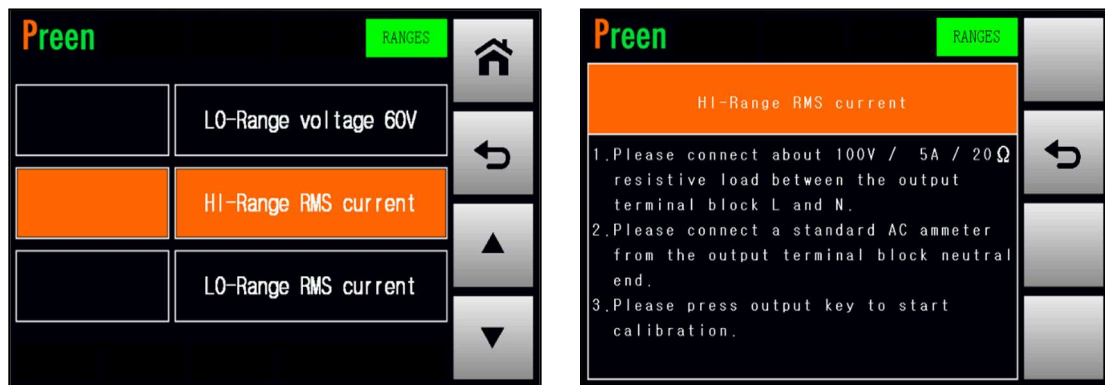

Figure 4.13 Enter into the page which calibrates the HI-Range RMS current

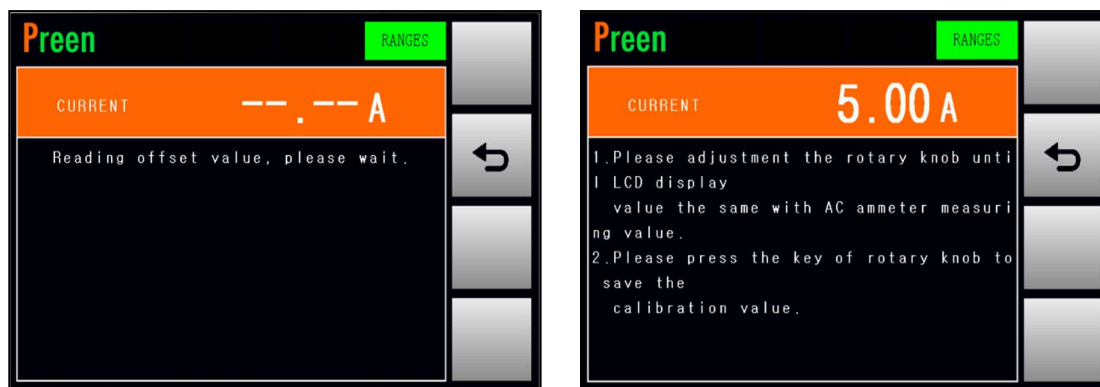

Figure 4.14 Enable the calibration of the HI-Range RMS current

4.6 LO-Range RMS Current

At the CALIBRATION page 2, users are allowed to enter into the page which calibrates the LO-Range RMS current. The procedures of calibrating the LO-Range RMS current are given as below:

HI-Range RMS current

1. Press the item HI-Range RMS current repeatedly to enter into the page which calibrates the LO-Range RMS current (refer to Figure 4.15).
2. Connect the product with the current meter and suitable load (refer to Figure 4.1).
3. Press the output & reset button on the front panel to enable the calibration of the LO-Range RMS current (refer to Figure 4.16), and then the product will start to output the voltage which is closed to 100V.
4. Use the rotary knob to adjust the product output until the measurement reading of the output current shown on the touch screen is closed to the measurement reading shown on the current meter.
5. Press the rotary knob to confirm and finish the calibration.

NOTICE

The definition of the suitable load for calibrating the LO-Range RMS current are given as follows, and the suitable load shall be resistive load.

Model	Resistive Value	Rated Power
AFV-P-600	200Ω	50W
AFV-P-1250	100Ω	100W
AFV-P-2500	50Ω	200W
AFV-P-5000	25Ω	400W

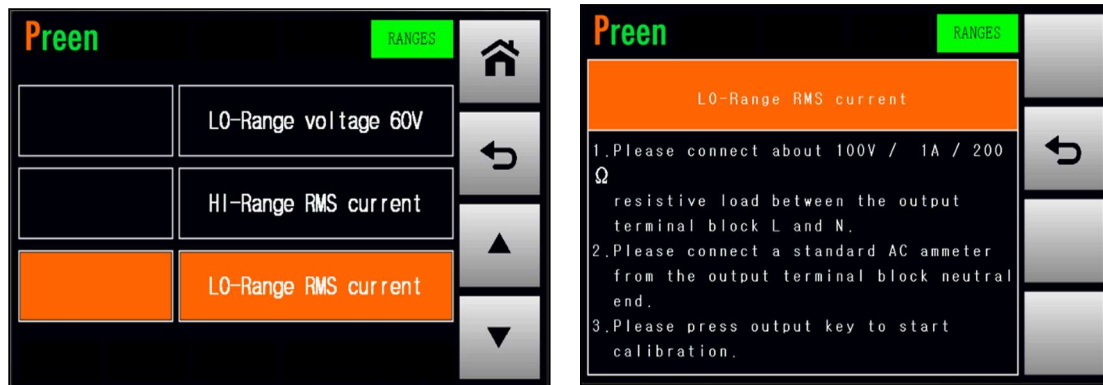

Figure 4.15 Enter into the page which calibrates the LO-Range RMS current

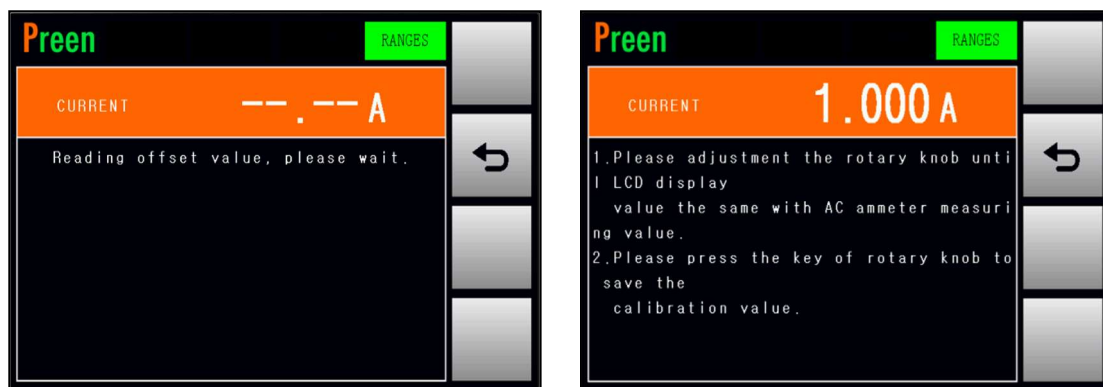

Figure 4.16 Enable the calibration of the LO-Range RMS current

4.7 Peak Current

At the CALIBRATION page 3, users are allowed to enter into the page which calibrates the peak current. The procedures of calibrating the peak current are given as below:

Peak Current

1. Press the item Peak Current repeatedly to enter into the page which calibrates the peak current (refer to Figure 4.17).
2. Connect the product with the current meter and suitable load (refer to Figure 4.1).
3. Press the output & reset button on the front panel to enable the calibration of the peak current (refer to Figure 4.18), and then the product will start to output the voltage which is closed to 100V.
4. Use the rotary knob to adjust the product output until the measurement reading of the peak current shown on the touch screen is closed to the measurement reading shown on the current meter.
5. Press the rotary knob to confirm and finish the calibration.

NOTICE		
The definition of the suitable load for calibrating the peak current are given as follows, and the suitable load shall be resistive load.		
Model	Resistive Value	Rated Power
AFV-P-600	20Ω	500W
AFV-P-1250	10Ω	1000W
AFV-P-2500	5Ω	2000W
AFV-P-5000	2.5Ω	4000W

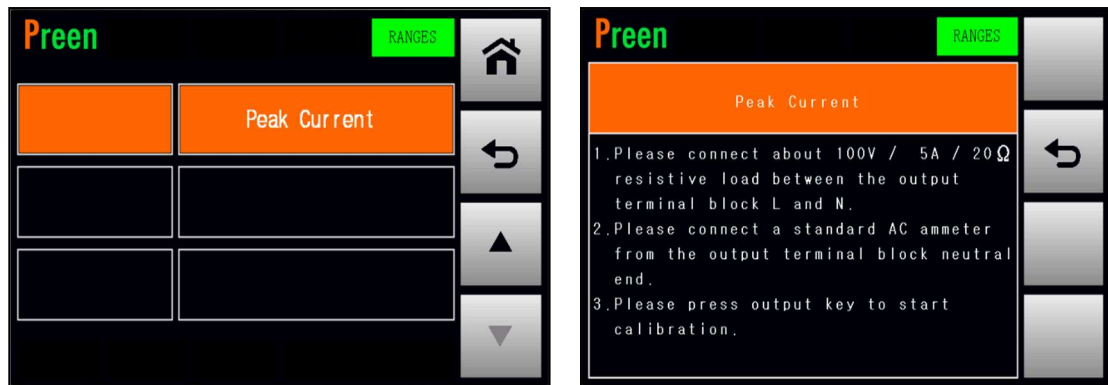

Figure 4.17 Enter into the page which calibrates the peak current

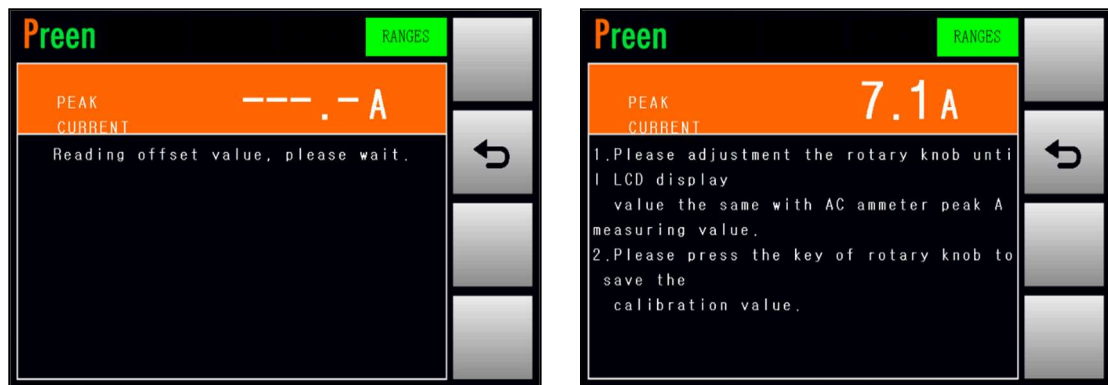

Figure 4.18 Enable the calibration of the peak current

4.8 Output Socket Current (Specialize for AFV-P-5000)

At the CALIBRATION page 3, users are allowed to enter into the page which calibrates the output socket current. Since the maximum output current corresponding to the product model of AFV-P-5000 is 40A, which exceeds the maximum rated current of the AC output socket (that is, 20A), the calibration of the output socket current is necessary to protect the AC output socket from over current damage.

The procedures of calibrating the output socket current are given as below:

1. Press the item Output socket current repeatedly to enter into the page which calibrates the output socket current (refer to Figure 4.19).
2. Connect the product with the current meter and the load with 5Ω and the rated power exceeding 2000W (refer to Figure 4.1).
3. Press the output & reset button on the front panel to enable the calibration of the output socket current (refer to Figure 4.20), and then the product will start to output the voltage which is closed to 100V.
4. Use the rotary knob to adjust the product output until the measurement reading of the output current shown on the touch screen is closed to the measurement reading shown on the current meter.
5. Press the rotary knob to confirm and finish the calibration.

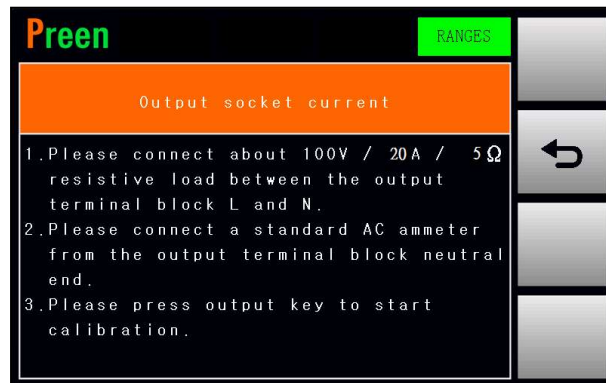

Figure 4.19 Enter into the page which calibrates the output socket current



Figure 4.20 Enable the calibration of the output socket current

5 PROGRAMMABLE Features

5.1 General

The product can not only provide the steady output voltage and output frequency, but also provide several powerful functions to simulate all kinds of power line conditions and disturbance. Users can make the output change according to the setting value step by step via the STEP feature (refer to Subsection 5.2), or make the output change according to the setting slew rate via the RAMP feature (refer to Subsection 5.3), even make the output change according to the setting value for a specific period of time via the TRANSIENT feature (refer to Subsection 5.4).

A. PROGRAMMABLE Page

Two options of entering into the PROGRAMMABLE page are given as below,

1. At the MAIN page, users can press the icon  to enter into the PROGRAMMABLE page.

2. At the MENU page 1, users can press the icon  to enter into the PROGRAMMABLE page.



Figure 5.1 MAIN page

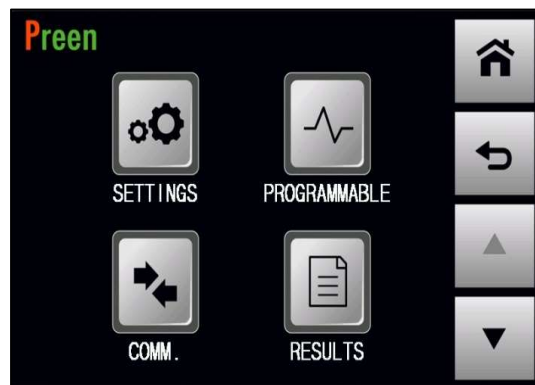

Figure 5.2 MENU page 1

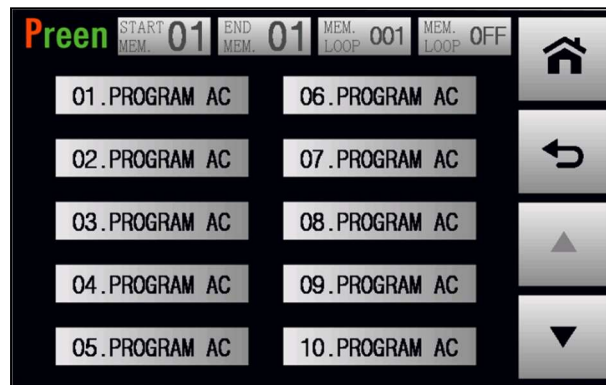

Figure 5.3 PROGRAMMABLE page when the Memory Loop is off

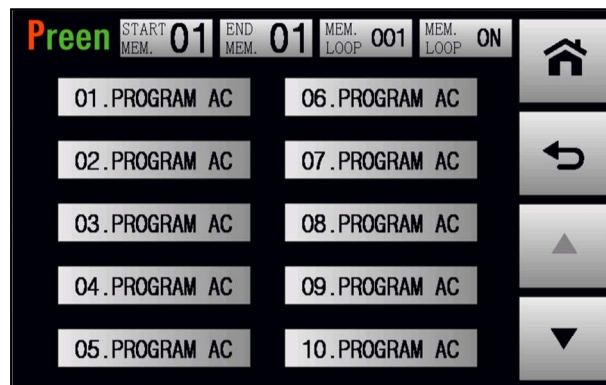

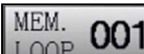







Figure 5.4 PROGRAMMABLE page when the Memory Loop is on

The description for the icons at the PROGRAMMABLE page are given as follows,









- 1)  : Press to set the start number of the Memory Loop, with options from 1 to 50.
- 2)  : Press to set the end number of the Memory Loop, with options from 1 to 50.
- 3)  : Press to set the Memory Loop times, with options from 1 to 999.
- 4)  /  : Press to enable/disable the Memory Loop.
- 5)  : Press to set the desired Memory Set.
- 6)  : Press to move to the previous page of the PROGRAMMABLE page to select the desired Memory Set.

- 7)  : Press to move to the next page of PROGRAMMABLE page to select the desired Memory Set.

B. Memory Loop

At the PROGRAMMABLE page, users are allowed to set the Memory Loop, and 50 Memory Sets are supported for simulating power line conditions and disturbance. For example, when the start number of the Memory Loop is 2, the end number of the Memory Loop is 6, and the Memory Loop times is 5, the Memory Loop will be sequentially performed from the Memory Set 2 to the Memory Set 6 and repeated 5 times.

The procedures of setting the Memory Loop according to the example mentioned above are given as below,

1. Press the icon  /  to enable the Memory Loop.
2. Press the icon  to set the value of 2, and press the icon  to confirm.
3. Press the icon  to set the value of 6, and press the icon  to confirm.
4. Press the icon  to set the value of 5, and press the icon  to confirm.
5. Press the output & reset button, then the Memory Loop is performed.

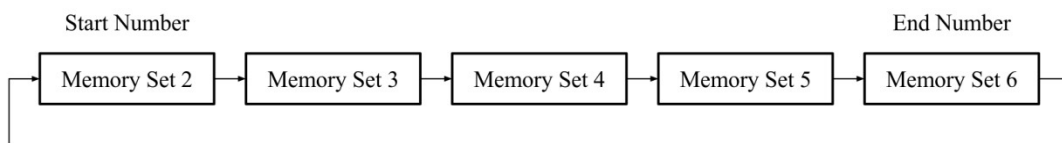

Repeat the Memory Loop 5 Times

When the Memory Loop is performed, the following page will be shown on the touch screen,

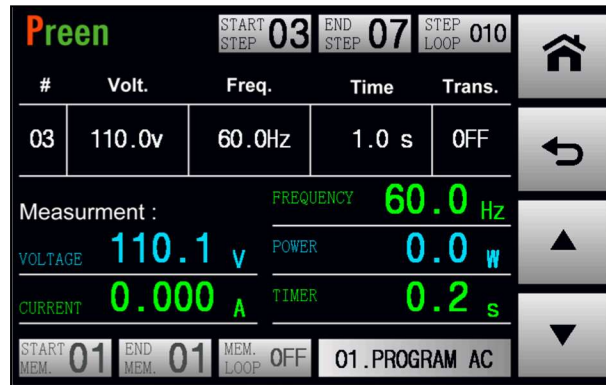

Figure 5.5 PROGRAMMABLE page when the Memory Loop is performed

5.2 STEP Feature

A. STEP Page

At the PROGRAMMABLE page, users are allowed to enable the STEP feature which makes the output change step by step at the STEP page, and 24 STEPs for each Memory Set are supported. To enter into the STEP page of the desired Memory Set, users can press the icon of the desired Memory Set.

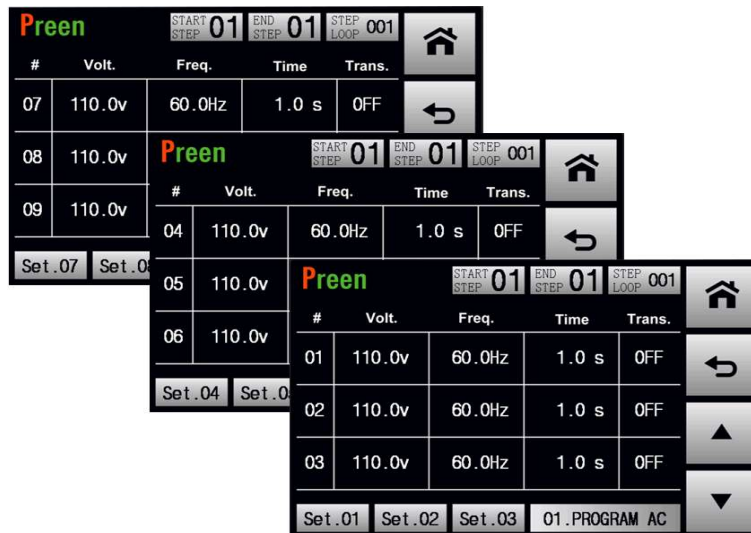

Figure 5.6 STEP page

For example, users can press the icon of the Memory Set 1 to enter into the STEP page of the Memory Set 1.

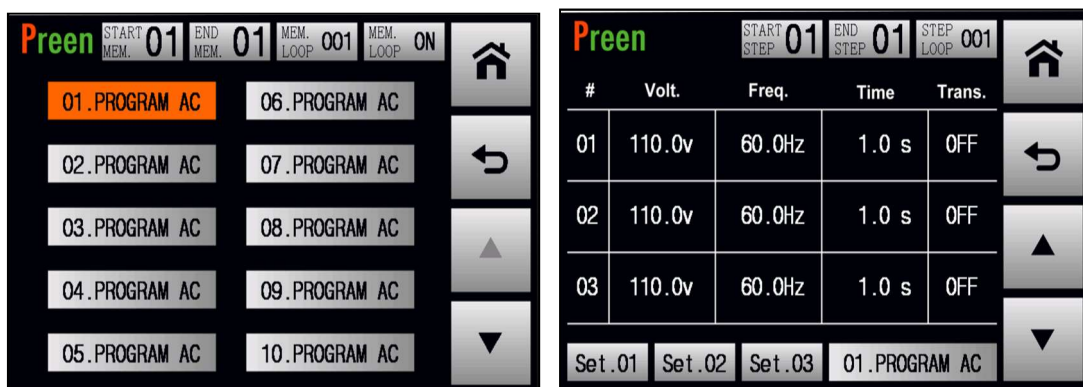





Figure 5.7 Enter into the STEP page of the Memory Set 1



The description for the items and the icons at the STEP page are given as follows,

- 1)  : Press to set the start number of the Step Loop, with options

from 1 to 24.

2)  : Press to set the end number of the Step Loop, with options from 1 to 24.

3)  : Press to set the Step Loop times, with options from 1 to 999.

4)  /  /  : Press to enter into the subpage of the desired Step.

5)  : Show the label number of the current Memory Set.

6)  : Press to enable/disable the desired Step.

7)  : Press to set the output voltage of the desired Step.

8)  : Press to set the output frequency of the desired Step.

9)  : Press to set the dwell time of the desired Step.



10)  : Press to enter into the TRANSIENT page.



11)  : Press to move to the previous page of the STEP page.



12)  : Press to move to the next page of STEP page.

For example, when the start number of the Step Loop is 3, the end number of the Step Loop is 7, and the Step Loop times is 10, but the Step 5 is disabled, the Step Loop will be sequentially performed from the Step 3 to the Step 7 except the Step 5 and repeated 10 times.

The procedures of set the Step Loop according to the example mentioned above are given as below,

1. Press the icon  to set the value of 3, and press the icon  to confirm.

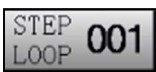
2. Press the icon  to set the value of 7, and press the icon  to confirm.

3. Press the icon  to set the value of 10, and press the icon  to confirm.

4. Press the item  of the Step 5 to disable the Step 5.

5. Press the output & reset button, then the Step Loop is performed.

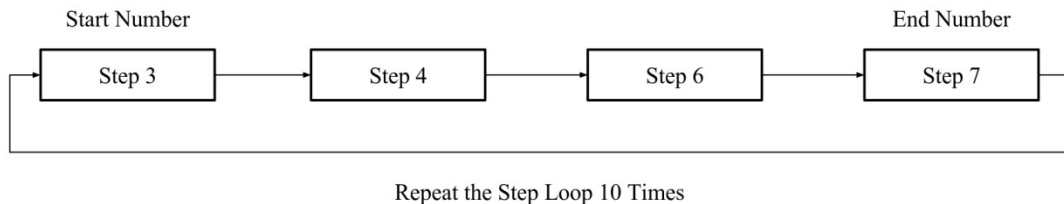

When the Step Loop is performed, the following page will be shown on the touch screen,

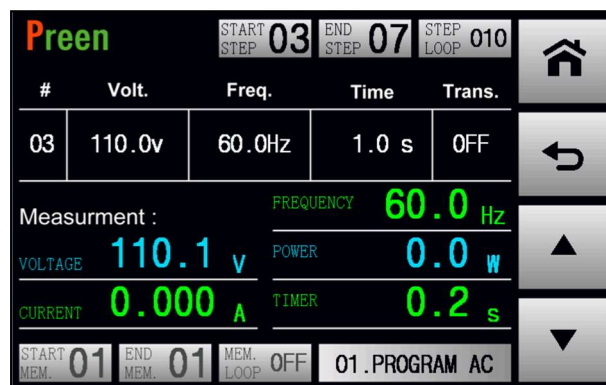

Figure 5.8 STEP page when the Step Loop is performed

B. STEP Feature Example

To illustrate the STEP feature, the figures shown below are the example of setting the STEP feature for the Step 1 & 2 & 3 and the output waveform corresponding to this example.

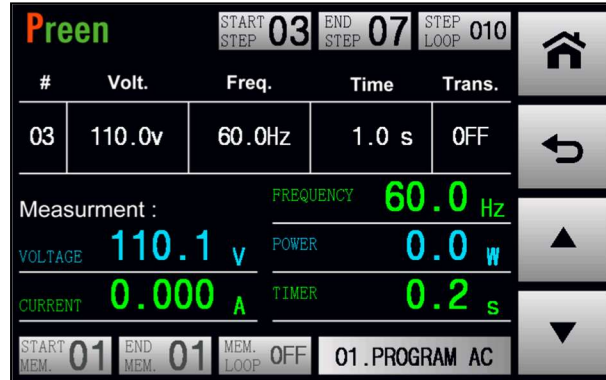

Figure 5.9 Example of setting the STEP feature for the Step 1 & 2 & 3

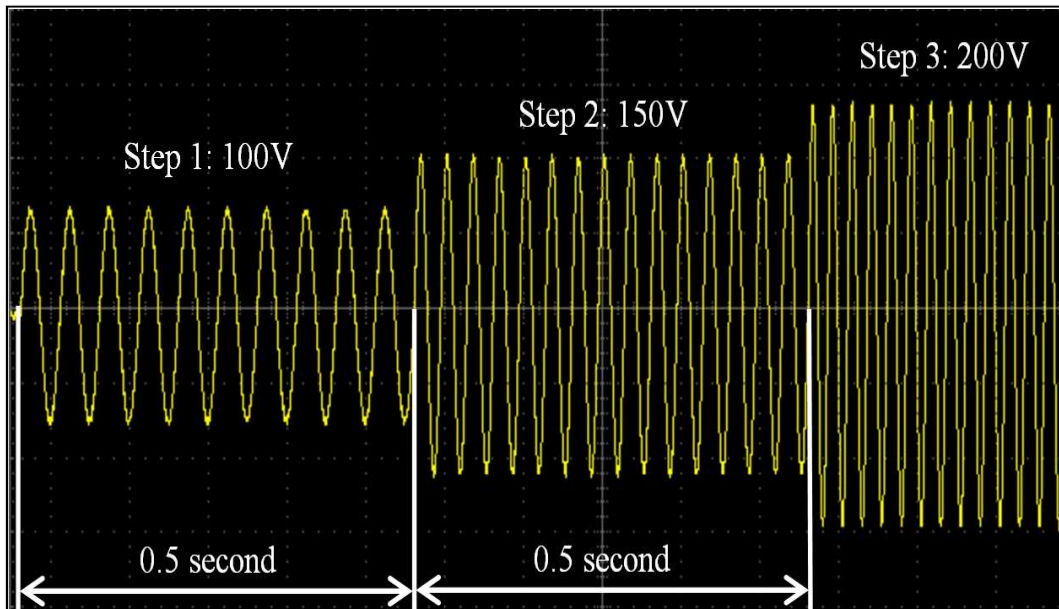

Figure 5.10 Output Waveform corresponding to the example above

C. GENERAL Subpage

When the STEP page is shown on the touch screen, users can press the icon



to enter into the subpages of the Step 1. Similarly, users can press the



icon to enter into the subpages of the Step 2, and so on.

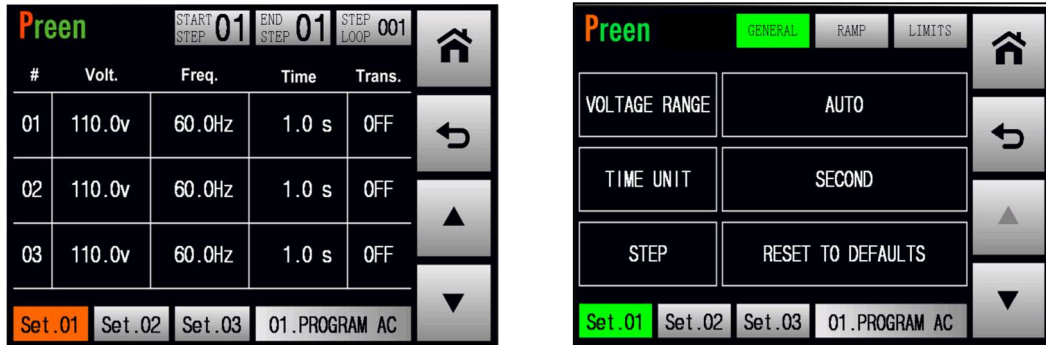

Figure 5.11 Enter into the GENERAL subpage

These subpages include the GENERAL subpage, RAMP subpage and LIMITS subpage, and the GENERAL subpage will be shown on the touch screen in advance after

pressing the icon . Please see the following figures,

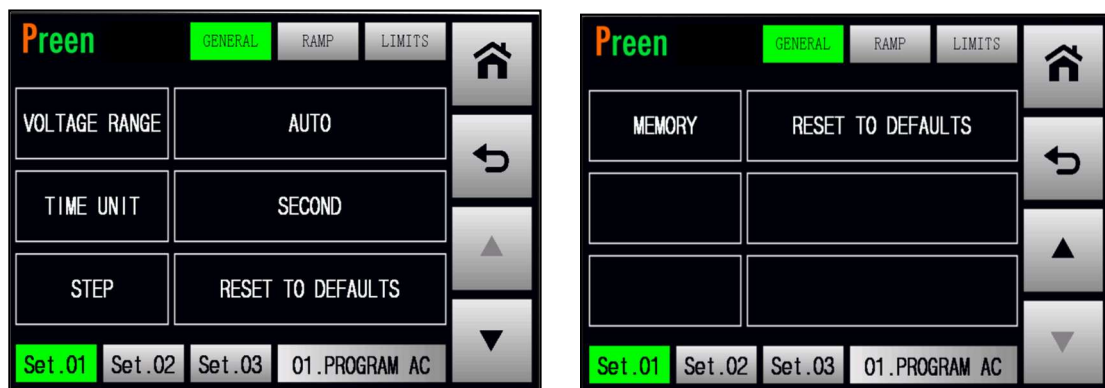









Figure 5.12 GENERAL subpage 1 & 2



The description for the items and the icons at the GENERAL subpage are given as follows,

- 1) : Press to set the output voltage range, with two options HIGH and AUTO.
- 2) : Press to set the time unit for the dwell time of the

desired Step, with three options from SECOND, MINUTE and HOUR.

- 3)   : Press to reset the desired Step to the default settings.
- 4)   : Press to reset all Steps of the desired Memory Set to the default settings.
- 5)  : Press to enter into the RAMP subpage (refer to Subsection 5.3).
- 6)  : Press to enter into the LIMITS subpage.
- 7)  : Press to move to the previous page of the GENERAL subpage.
- 8)  : Press to move to the next page of GENERAL subpage.

D. RAMP Subpage

After pressing the icon  at the STEP page, the GENERAL subpage will be shown on the touch screen in advance, and users can press the icon  to enter into the RAMP subpage. For detail description of the RAMP subpage, please refer to Subsection 5.2.

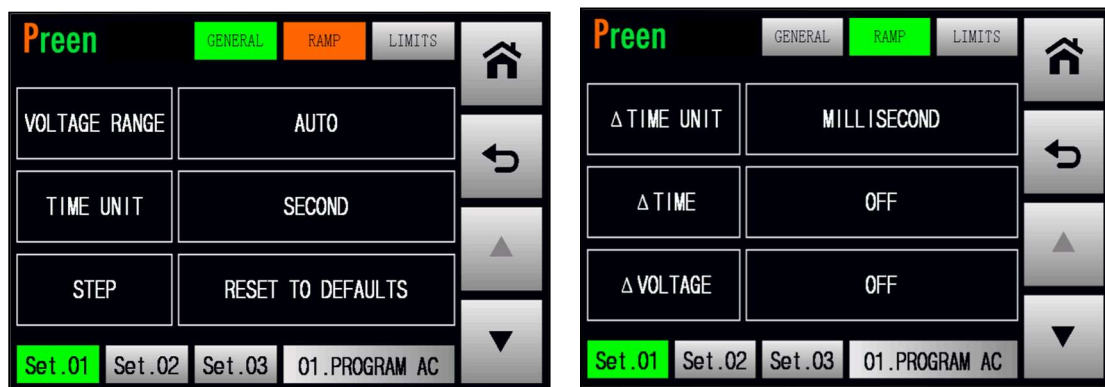

Figure 5.13 Enter into the RAMP subpage

E. LIMITS Subpage



After pressing the icon  at the STEP page, the GENERAL subpage will be shown on the touch screen in advance. Then users can press the icon  to enter into the LIMITS subpage, and enable the LIMITS feature to perform the output test for the desired Step. Please see the following figures,



Figure 5.14 Enter into the LIMITS subpage



Figure 5.15 LIMITS subpage 1 & 2

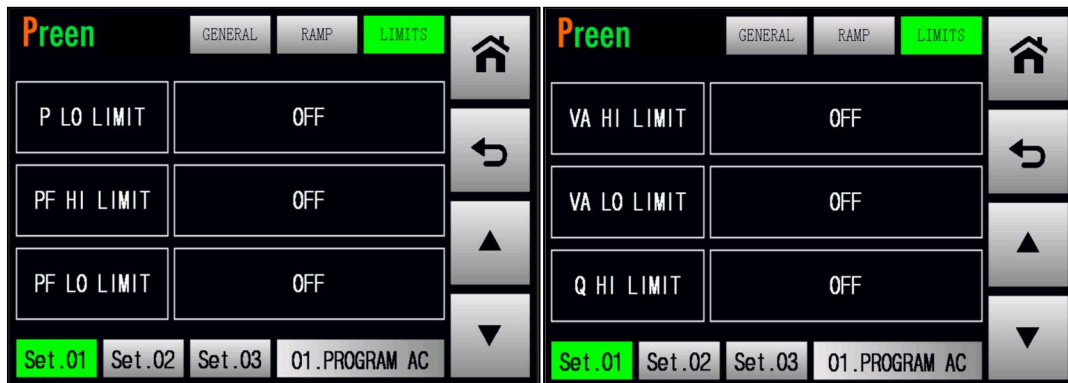

Figure 5.16 LIMITS subpage 3 & 4



Figure 5.17 LIMITS subpage 5

The description for the items and the icons at the GENERAL subpage of the Step 1 are given as follows,

- 1)

DELAY TIME	0.5 s
------------	-------

 : Press to set the delay time to perform the LIMITS feature, with options from 0.5s to 999.9s, and the default option is 0.5s. While setting the delay time less than 0.5s, the feature of the delay time will be disabled, and this icon status will be OFF.
- 2)

A HI LIMIT	OFF
------------	-----

 : Press to set the maximum rated current for the desired Step, with options from 0.01A to 5A for the product model of AFV-P-600; from 0.01A to 10A for the product model of AFV-P-1250; from 0.01A to 20A for the product model of AFV-P-2500; from 0.01A to 40A for the product model of AFV-P-5000. While setting the maximum rated current less than 0.01A, the output test of the maximum rated current will be disabled, and this icon status will be OFF.
- 3)

A LO LIMIT	OFF
------------	-----

 : Press to set the minimum rated current for the desired Step, with options which are similar to that of the maximum rated current.
- 4)

AP HI LIMIT	OFF
-------------	-----

 : Press to set the maximum rated peak current for the desired Step, with options from 0.1A to 23A for AFV-P-600; from 0.1A to 45A for AFV-P-1250; from 0.1A to 90A for AFV-P-2500; from 0.1A to 180A for AFV-P-5000. While setting the maximum rated peak current less than 0.1A, the output test of the maximum rated peak current will be disabled, and this icon status will be OFF.
- 5)

AP LO LIMIT	OFF
-------------	-----

 : Press to set the minimum rated peak current for the

desired Step, with options which are similar to that of the maximum rated peak current.

- 6)

P HI LIMIT	OFF
------------	-----

 : Press to set the maximum rated power for the desired Step, with options from 1W to 500W for AFV-P-600; from 1W to 1000W for AFV-P-1250; from 1W to 2000W for AFV-P-2500; from 1W to 4000W for AFV-P-5000. While setting the maximum rated power less than 1W, the output test of the maximum rated power will be disabled, and this icon status will be OFF.

- 7)

P LO LIMIT	OFF
------------	-----

 : Press to set the minimum rated power for the desired Step, with options which are similar to that of the maximum rated power.

- 8)

PF HI LIMIT	OFF
-------------	-----

 : Press to set the maximum rated power factor for the desired Step, with options from 0.001 to 1. While setting the maximum rated power factor less than 0.001, the output of the maximum rated power factor will be disabled, and this icon status will be OFF.

- 9)

PF LO LIMIT	OFF
-------------	-----

 : Press to set the minimum rated power factor for the desired Step, with options which are similar to that of the maximum rated power factor.

- 10)

VA HI LIMIT	OFF
-------------	-----

 : Press to set the maximum rated apparent power for the desired Step, with options from 1VA to 600VA for AFV-P-600; from 1VA to 1250VA for AFV-P-1250; from 1VA to 2500VA for AFV-P-2500; from 1VA to 5000VA for AFV-P-5000. While setting the maximum rated apparent power less than 1VA, the output test of the maximum rated apparent power will be disabled, and this icon status will be OFF.

- 11)

VA LO LIMIT	OFF
-------------	-----



 : Press to set the minimum rated apparent power for the desired Step, with options which are similar to that of the maximum rated apparent power.

- 12)



Q HI LIMIT	OFF
------------	-----

 : Press to set the maximum rated reactive power for the desired Step, with options from 1VAR to 600VAR for AFV-P-600; from 1VAR to 1250VAR for AFV-P-1250; from 1VAR to 2500VAR for AFV-P-2500; from 1VAR to 5000VAR for AFV-P-5000. While setting the maximum rated

reactive power less than 1VAR, the output of the maximum rated reactive power will be disabled, and this icon status will be OFF.

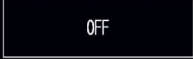
- 13)   : Press to set the minimum rated reactive power for the desired Step, with options which are similar to that of the maximum rated reactive power.

- 14)   : Press to set the maximum rated crest factor for the desired Step, with options from 0.01 to 10. While setting the maximum rated crest factor less than 0.01, the output test of the maximum rated crest factor will be disabled, and this icon status will be OFF.

- 15)   : Press to set the minimum rated crest factor for the desired Step, with options which are similar to that of the maximum rated crest factor.

- 16)  : Press to move to the previous page of the LIMITS subpage.

- 17)  : Press to move to the next page of LIMITS subpage.

NOTICE

The LIMITS feature can be performed with the STEP feature simultaneously, so as to perform the output test for the STEP feature. However, when either the RAMP feature or the TRANSIENT feature is enabled, the LIMITS feature will not be disabled.

5.3 RAMP Feature

A. RAMP Page

At the RAMP subpage, users are allowed to enable the RAMP feature which makes the output change according to the setting slew rate. Please see the following figures,

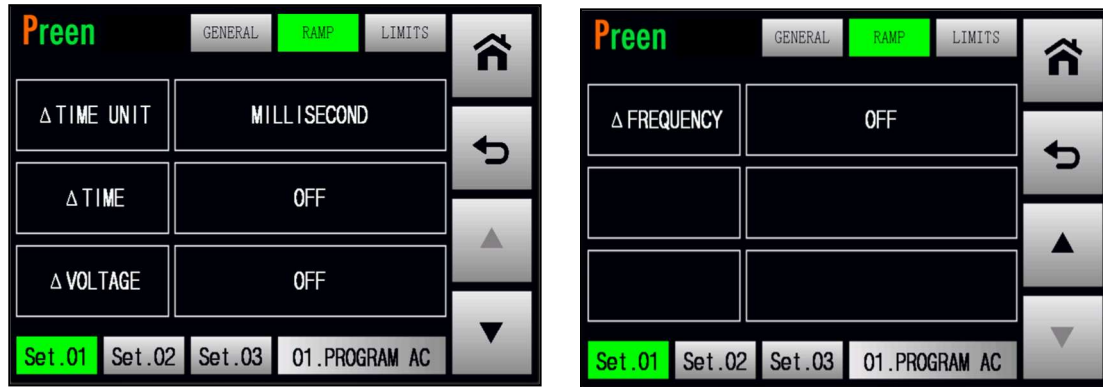

Figure 5.18 RAMP subpage 1 & 2

The description for the items at the RAMP subpage are given as follows,

- 1)

Δ TIME UNIT	MILLISECOND
-------------	-------------

 : Press to set the Ramp time unit, with three options of MILLISECOND, SECOND and CYCLE.
- 2)

Δ TIME	OFF
--------	-----

 : Press to set the Ramp time per unit, with options from 1 to 9999. While setting the Ramp time per unit less than a default value (for Ramp time unit SECOND and CYCLE, this constant value is 1; for Ramp time unit MILLISECOND, this constant value is 10), the setting of the Ramp time per unit is disabled, and this icon status will be OFF.
- 3)

Δ VOLTAGE	OFF
-----------	-----

 : Press to set the Ramp voltage per unit, with options from 0.1V to 310V. While setting the Ramp voltage per unit less than 0.1V, the setting of the Ramp voltage per unit is disabled, and this icon status will be OFF.
- 4)

Δ FREQUENCY	OFF
-------------	-----

 : Press to set the Ramp frequency per unit, with options from 0.1Hz to 500Hz. While setting the Ramp frequency per unit less than 0.1Hz, the setting of the Ramp frequency per unit is disabled, and this icon status will be OFF.

5)  : Press to move to the previous page of the RAMP subpage.

6)  : Press to move to the next page of RAMP subpage.

B. RAMP Feature Example

To illustrate the RAMP feature, the figures shown below are the example of setting the RAMP feature for the Step 1 and the output waveform corresponding to this example.

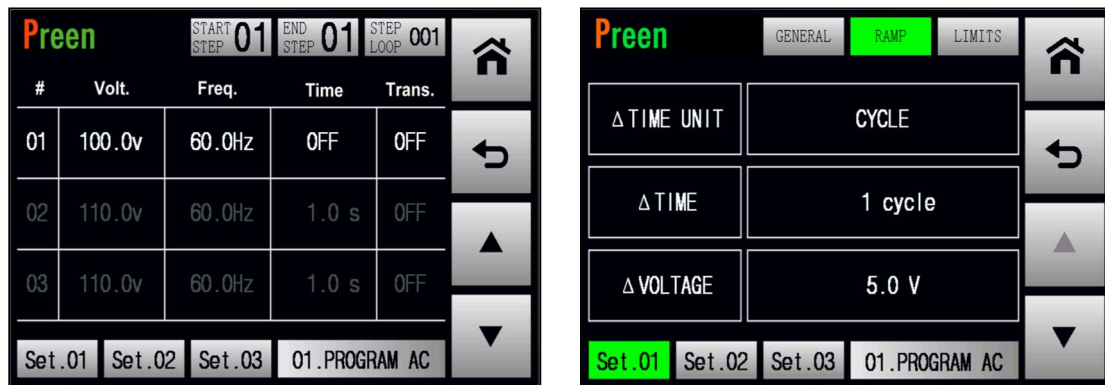

Figure 5.19 Example of setting the RAMP feature for the Step 1

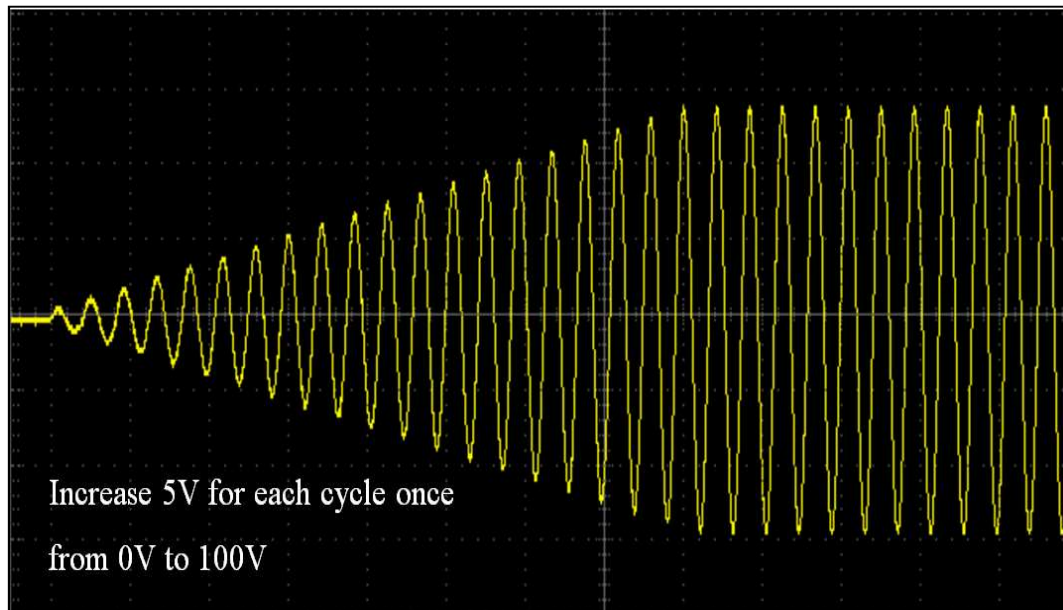
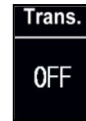
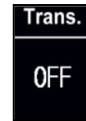

Figure 5.20 Output waveform corresponding to the example above

5.4 TRANSIENT Feature

A. TRANSIENT Page



If the STEP page is shown on the touch screen, users can press the item  to enter into the TRANSIENT page, and users are allowed to enable the TRANSIENT feature which makes the output change for a specific period of time at the TRANSIENT page. Please see the following figures,

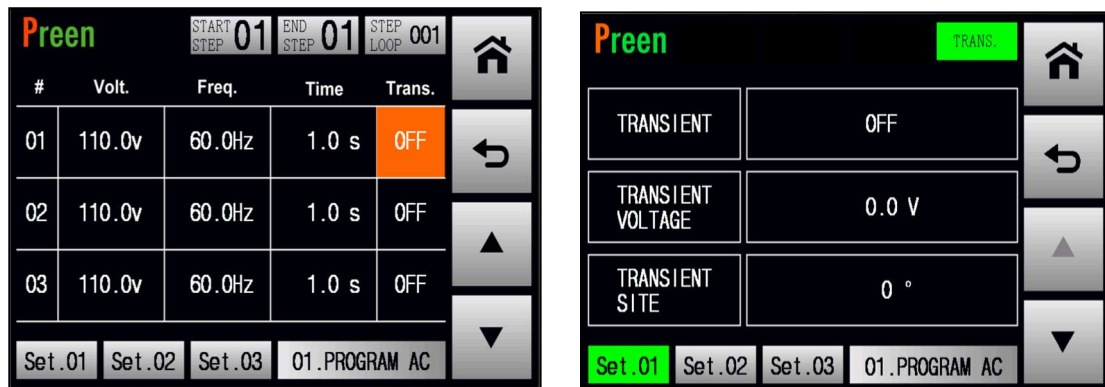

Figure 5.21 Enter into the TRANSIENT page

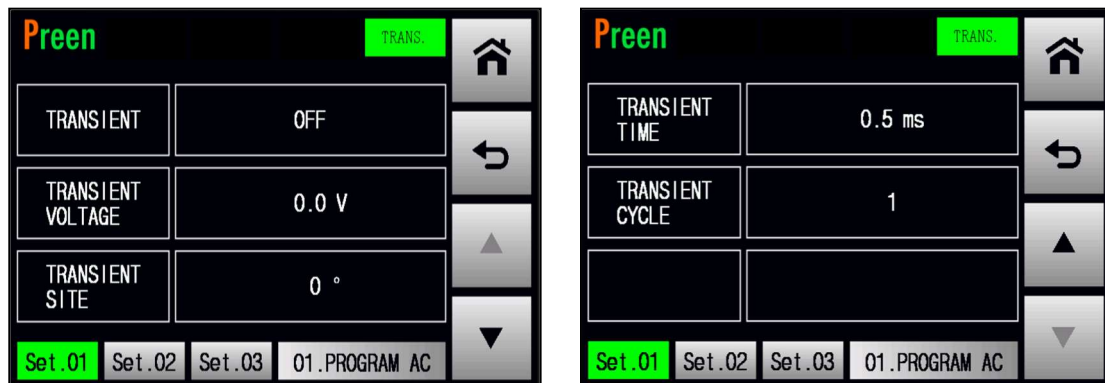







Figure 5.22 TRANSIENT page 1 & 2

The description for the items at the TRANSIENT page are given as follows,

- 1)  : Press to enable/disable the TRANSIENT feature.
- 2)  : Press to set the Transient voltage, with options from 0.1V to 310V. While setting the Transient voltage less than 0.1V, the Transient voltage will be automatically set to 0V.
- 3)  : Press to set the Transient site, with options from 0°

to 359°.

- 4)  : Press to set the Transient dwell time, with options from 0.5ms to 999.9ms.

- 5)  : Press to set the Transient cycle times, with options from 1 to 9999. While setting the Transient cycle times to 0, the Transient feature will be performed every cycle once.

- 6)  : Press to move to the previous page of the TRANSIENT page.

- 7)  : Press to move to the next page of TRANSIENT page.

B. TRANSIENT Feature Example

To illustrate the TRANSIENT feature, the figures shown below are the example of setting the TRANSIENT feature for the Step 1 and the output waveform corresponding to this example.

Preen					START STEP 01	END STEP 01	STEP LOOP 001	Home
#	Volt.	Freq.	Time	Trans.				
01	100.0v	60.0Hz	OFF	ON				
02	110.0v	60.0Hz	1.0 s	OFF				
03	110.0v	60.0Hz	1.0 s	OFF				
Set .01		Set .02		Set .03		01 .PROGRAM AC		Down Arrow

Figure 5.23 Example of setting the TRANSIENT feature for the Step 1

Preen		TRANS	Home
TRANSIENT	ON		Up Arrow
TRANSIENT VOLTAGE	150.0 V		Down Arrow
TRANSIENT SITE	90 °		Home
Set .01		Set .02	Set .03
01 .PROGRAM AC			

Preen		TRANS	Home
TRANSIENT TIME	0.5 ms		Up Arrow
TRANSIENT CYCLE	1		Down Arrow
Set .01		Set .02	Set .03
01 .PROGRAM AC			

Figure 5.24 Example of setting the TRANSIENT feature for the Step 1

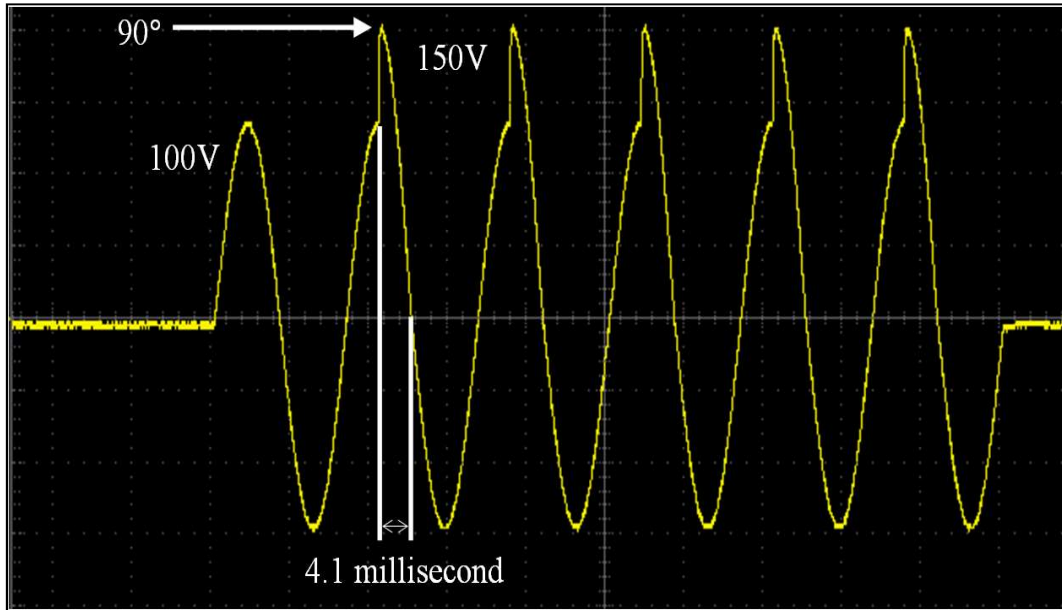

Figure 5.25 Output waveform corresponding to the example above

6 Theory of Operation

The product mainly consists of 8 function blocks, and each of the function blocks has its own specific function. The function blocks of the product are given as below,

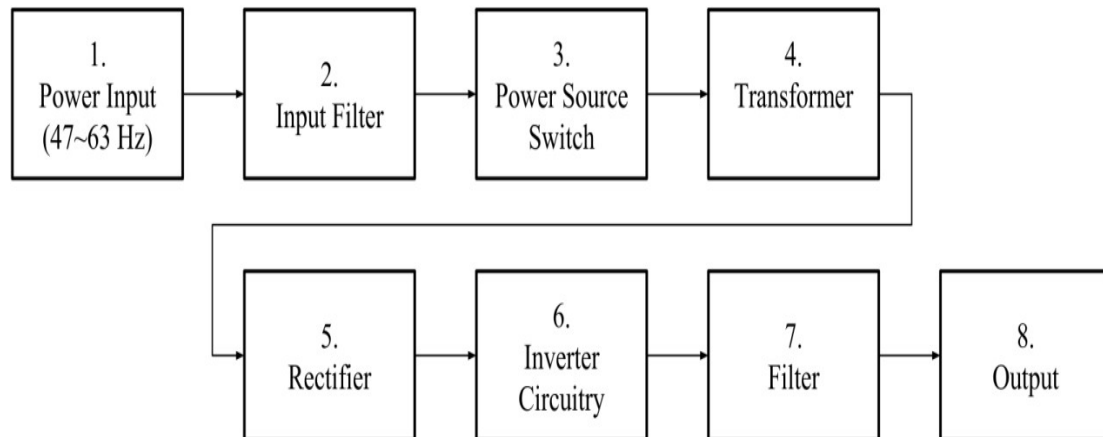

Figure 6.1 Function block of the product

7 Remote Operation

For remotely control the product via the remote control software released by Intepro Systems, please refer to the file “READ ME” in the attached CD-ROM which is encased with the product, so as to install the corresponding remote control software and device driver. For SCPI command list, please refer to the file “READ ME” to find the SCPI program-ming manual.

7.1 General

With the complete communication interfaces, the product can be controlled remotely via RS232, RS485 or USB. Additionally, the product provides the specialized remote control software that allows users to easily setup the remote control for the product without further need of programming. Please see the following figures,

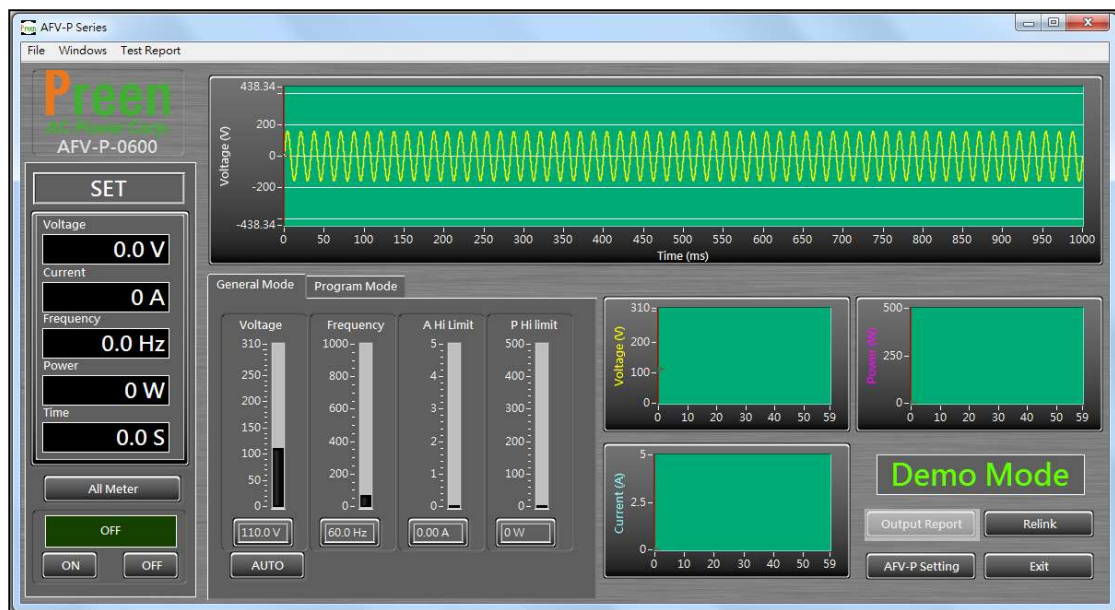

Figure 7.1 User interface of the remote control software when the product output is off

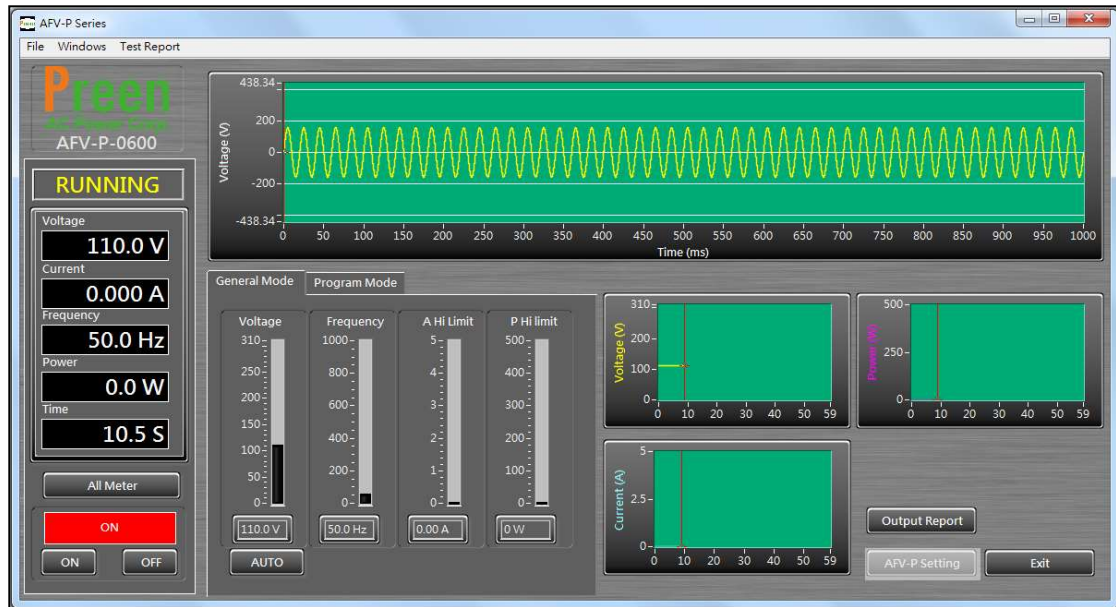

Figure 7.2 User interface of the remote control software when the product output is on

7.2 Remote Control Software: General Mode

After enabling the remote control software, the general mode of the remote control software will be shown in advance. Please see the following figure,

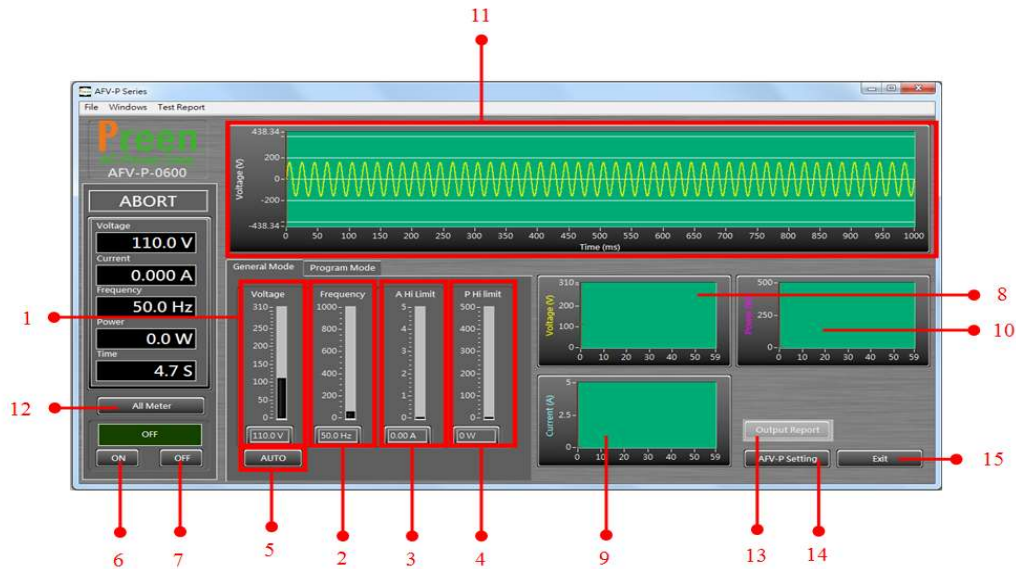

Figure 7.3 Remote control software: general mode

The description for the items and the icons at the general mode of the remote control software are given as follows,

- 1) Use to set the output voltage.
- 2) Use to set the output frequency.
- 3) Use to set the rated current.
- 4) Use to set the rated power.
- 5) Click to set the output voltage range.
- 6) Click to enable the product output.
- 7) Click to disable the product output.
- 8) Show the waveform of the output voltage.
- 9) Show the waveform of the output current.
- 10) Show the waveform of the output power.
- 11) Show the pre-simulated waveform of the output voltage.
- 12) Click to show the measurement readings of the product output (see Figure 7.4).
- 13) Click to download the product output report in the form of txt file or csv file (see Figure 7.5).
- 14) Click to enter into the setting page of the remote control software (see Figure 7.6). The description for the items at the setting page of the remote control

software is similar to the description for the SETTINGS page mentioned according to Subsection 3.5.

15) Click to exit the remote control software.

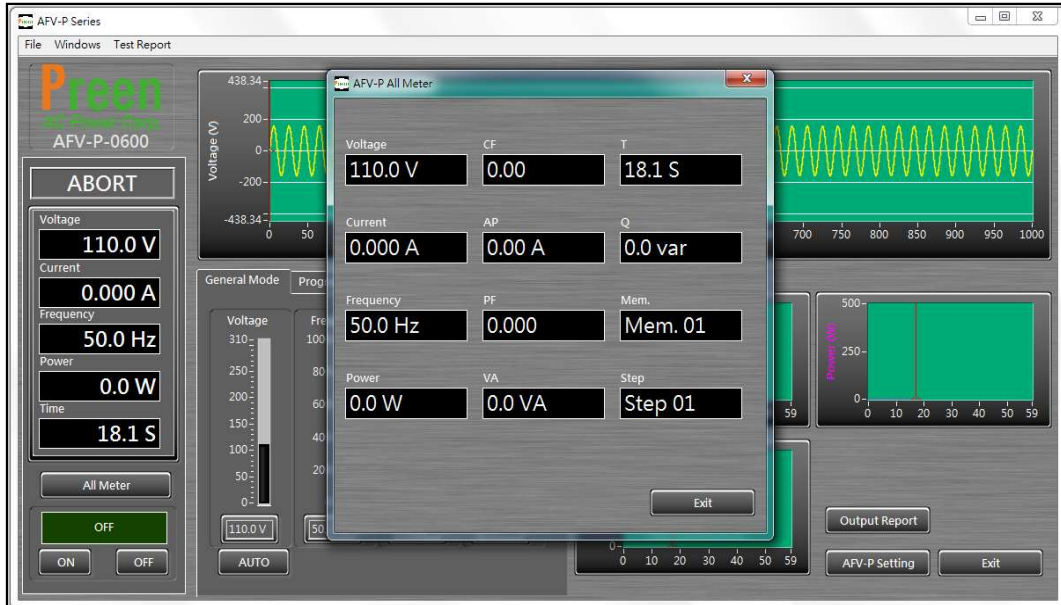

Figure 7.4 Show the measurement readings of the product output

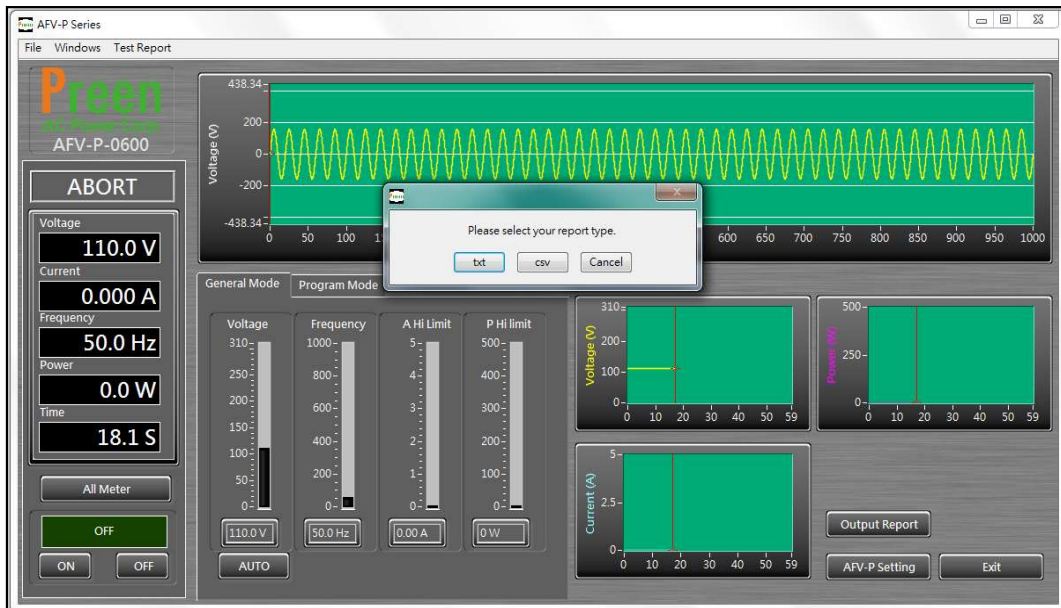

Figure 7.5 Select the desired file form of the product output report

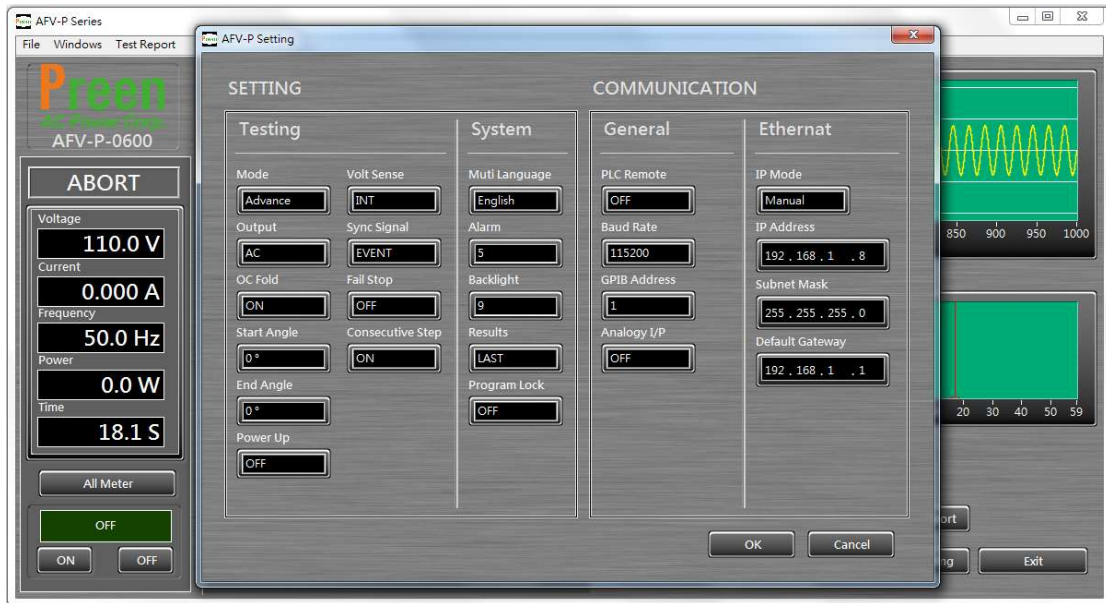

Figure 7.6 Setting page of the remote control software

7.3 Remote Control Software: Program Mode

To enter into the program mode of the remote control software, please click the icon “Program Mode” which is mark in red square below,

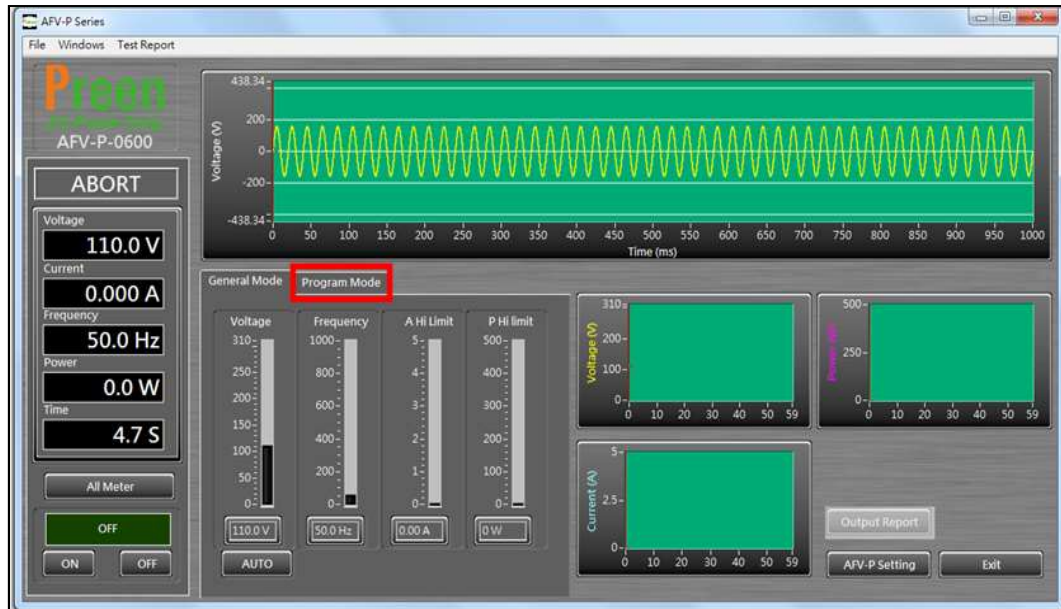

Figure 7.7 Click the icon “Program Mode” to enter into the program mode

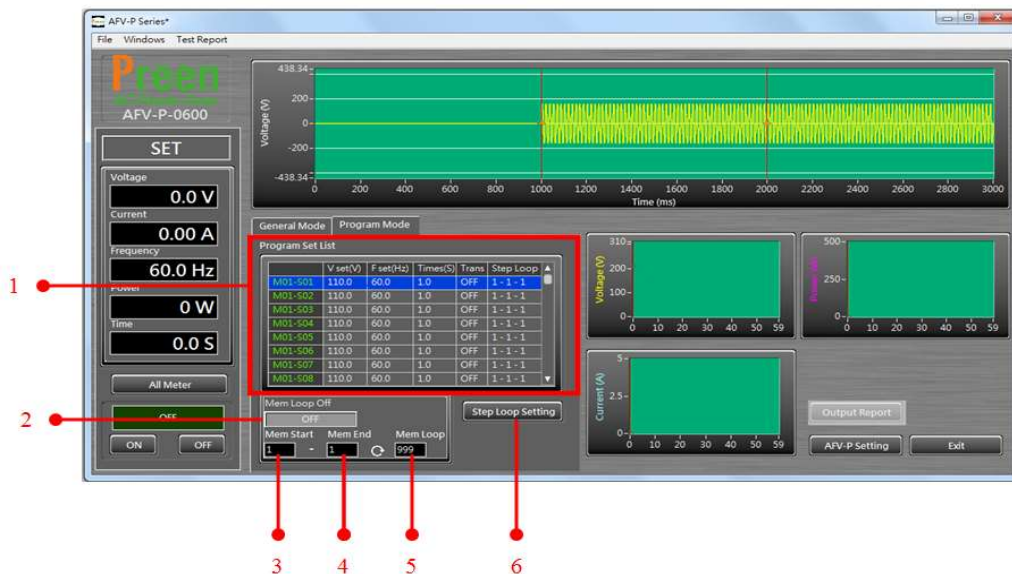

Figure 7.8 Remote control software: program mode.

The description for the items and the icons at the program mode of the remote control software are given as follows,

- 1) Click to enter into the PROGRAMMABLE page of the remote control software (see Figure 7.9) for the desired Step of the Memory Set. The description for the items at the PROGRAMMABLE page of the control software is similar to

the PROGRAMMABLE page mentioned according to Section 5.

- 2) Click to enable/disable the Memory Loop.
- 3) Use to set the start number of the Memory Loop.
- 4) Use to set the end number of the Memory Loop.
- 5) Use to set the Memory Loop times.
- 6) Click to set the start number/end number of the Step Loop and the Step Loop times for the desired Memory Set.



Figure 7.9 Setting page of the PROGRAMMABLE page



Figure 7.10 Set the Step Loop for the desire Memory Set

7.4 Remote Control Software: Additional Features

A. Reset to Default Settings

To reset the setting of the remote control software to the default setting, please do the following procedures step by step,

- 1 Click the item “File”, and then click the item “Load Default” (see Figure 7.11).
- 2 Select the desired settings to reset.
 - 2.1 Click the icon “Default System Data” to enable/disable the reset of the system data.
 - 2.2 Click the icon “Default AC Setting Date” to enable/disable the reset of the AC program mode.
 - 2.3 Click the icon “Default DC Setting Date” to enable/disable the reset of the DC program mode.
- 3 Click the icon “Start Load Default” to reset the program mode (see Figure 7.12).

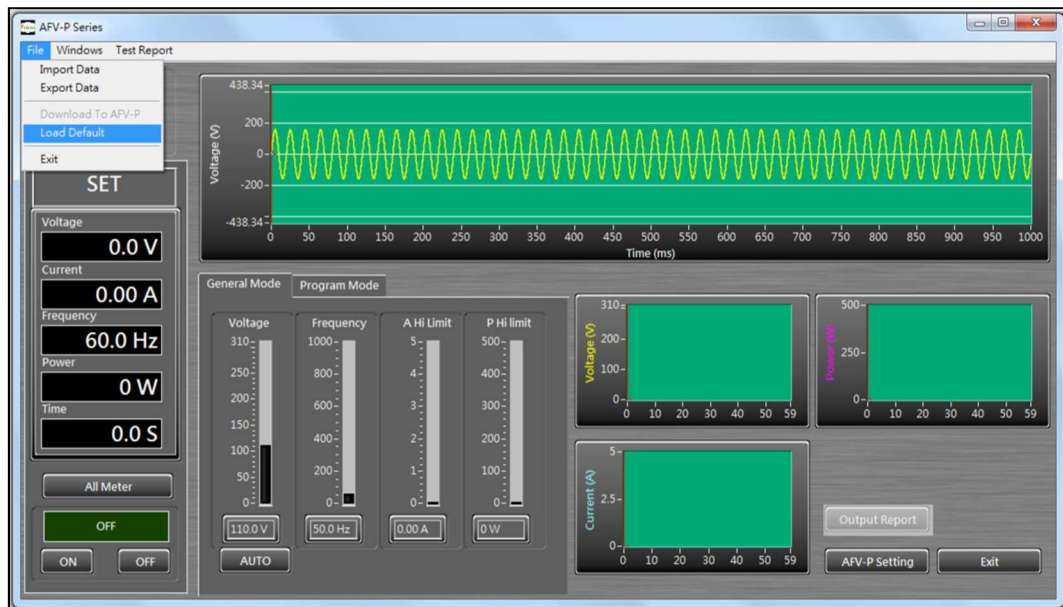

Figure 7.11 Item “File” and Item “Load Default”

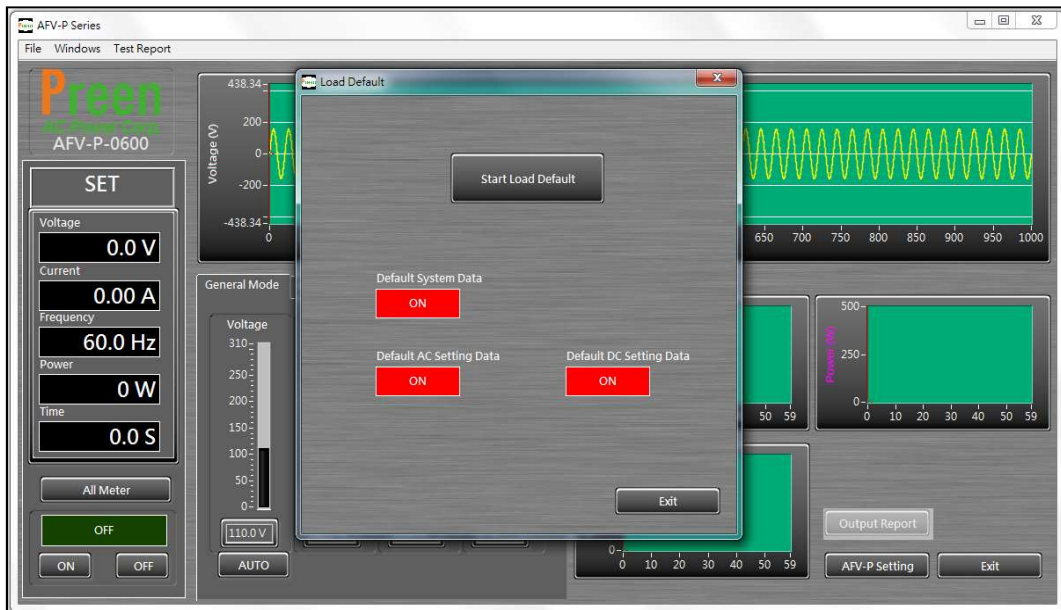

Figure 7.12 Select the desired settings to reset

B. Build Customized Product Output Report

To build the customized product output report, please do the following procedures step by step,

- 1 Click the item “Test Report”, and then click the item “Customize Report” (see Figure 7.13).
- 2 Select the desired items to show on the product output report (see Figure 7.14).
- 3 Click the icon “Output Report” to export the product output report.

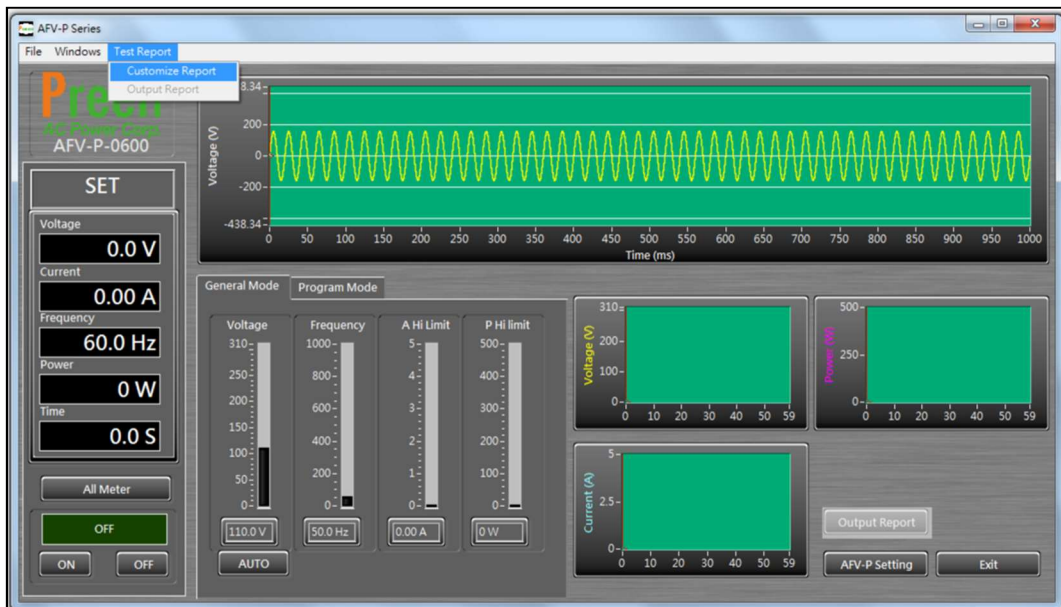

Figure 7.13 Item “Test Report” and Item “Customize Report”

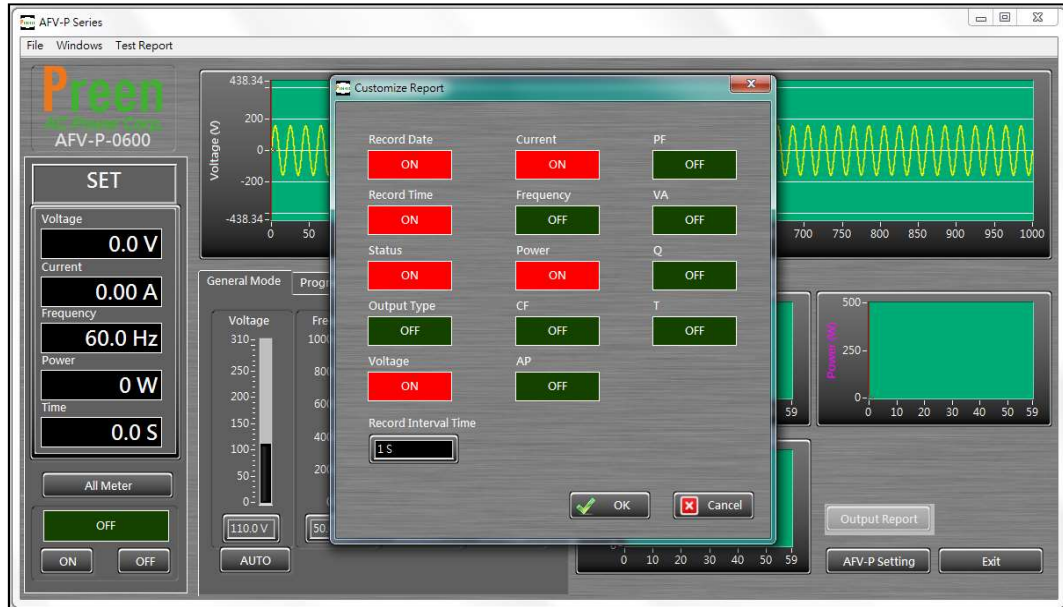

Figure 7.14 Select the desired items to show on the product output report