

INTEPRO SYSTEMS

Operating Manual

ELR 9000 HP

Electronic DC Load with Energy Recovery

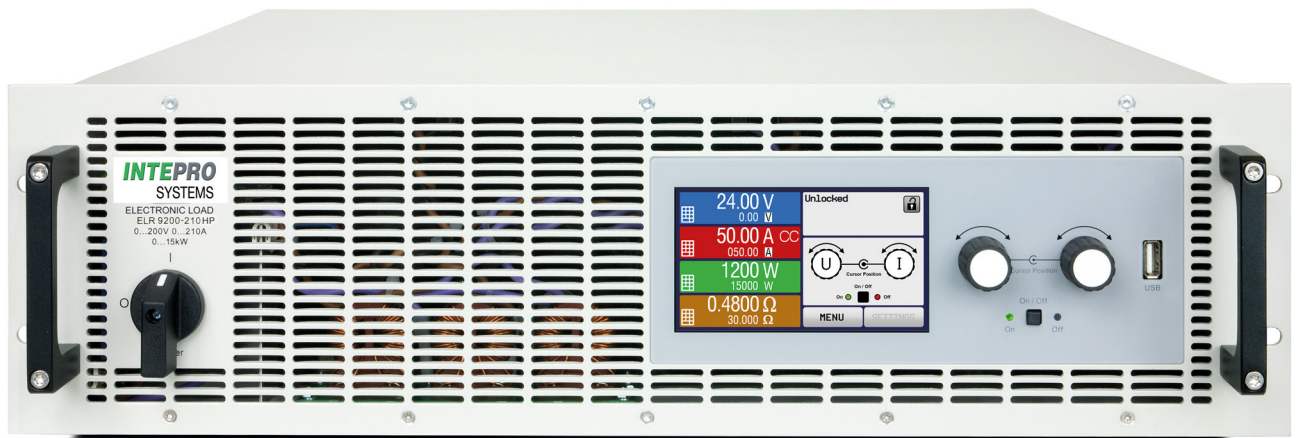

Attention! This document is only valid for devices with firmware "KE: 2.24" (standard version) resp. "KE: 2.08" (GPIB, 3W) and "HMI: 2.14" and "DR: 1.6.5" or higher. For availability of updates for your device check our website or contact us.



Date: 09/2018



TABLE OF CONTENTS

1. GENERAL

1.1	About this document	5
1.1.1	Retention and use	5
1.1.2	Copyright	5
1.1.3	Validity	5
1.1.4	Symbols and warnings	5
1.2	Warranty	5
1.3	Limit of liability	5
1.4	Disposal of equipment	6
1.5	Product key	6
1.6	Intended usage	6
1.7	Safety	7
1.7.1	Safety notices	7
1.7.2	Responsibility of the user	8
1.7.3	Responsibility of the operator	8
1.7.4	User requirements	8
1.7.5	Alarm signals	9
1.8	Technical data	9
1.8.1	Approved operating conditions	9
1.8.2	General technical data	9
1.8.3	Specific technical data	10
1.8.4	Views	18
1.8.5	Control elements	21
1.9	Construction and function	22
1.9.1	General description	22
1.9.2	Block diagram	22
1.9.3	Scope of delivery	23
1.9.4	Accessories	23
1.9.5	Options	23
1.9.6	The control panel (HMI)	24
1.9.7	USB-Port Type B (Back side)	27
1.9.8	Interface module slot	27
1.9.9	Analog interface	27
1.9.10	Share connector	28
1.9.11	Sense connector (remote sensing)	28
1.9.12	Master-Slave bus	28
1.9.13	GPIB port (optional)	28

2. INSTALLATION & COMMISSIONING

2.1	Transport and storage	29
2.1.1	Transport	29
2.1.2	Packaging	29
2.1.3	Storage	29
2.2	Unpacking and visual check	29
2.3	Installation	29
2.3.1	Safety procedures before installation and use	29
2.3.2	Preparation	30
2.3.3	Installing the device	30
2.3.4	Mains connection (AC)	31
2.3.5	Connection to DC sources	34

2.3.6	Grounding of the DC input	35
2.3.7	Connection of remote sensing	35
2.3.8	Connecting the "Share" bus	36
2.3.9	Installation of an interface module	36
2.3.10	Connecting the analog interface	37
2.3.11	Connecting the USB port (rear side)	37
2.3.12	Initial commission	37
2.3.13	Commission after a firmware update or a long period of non use	37

3. OPERATION AND APPLICATION

3.1	Personal safety	38
3.2	Operating modes	38
3.2.1	Voltage regulation / Constant voltage	38
3.2.2	Current regulation / constant current / current limitation	39
3.2.3	Resistance regulation / constant resistance	39
3.2.4	Power regulation / constant power / power limitation	39
3.2.5	Dynamic characteristics and stability criteria	39
3.3	Alarm conditions	40
3.3.1	Power Fail	40
3.3.2	Overtemperature	40
3.3.3	Overvoltage	40
3.3.4	Overcurrent	40
3.3.5	Overpower	40
3.4	Manual operation	41
3.4.1	Powering the device	41
3.4.2	Switching the device off	41
3.4.3	Configuration via MENU	41
3.4.4	Adjustment limits	51
3.4.5	Changing the operating mode	51
3.4.6	Manual adjustment of set values	52
3.4.7	Switching the main screen view	52
3.4.8	The meter bars	53
3.4.9	Switching the DC input on or off	53
3.4.10	Recording to USB stick (logging)	54
3.5	Remote control	55
3.5.1	General	55
3.5.2	Controls locations	55
3.5.3	Remote control via a digital interface	55
3.5.4	Remote control via the analog interface (AI)	56
3.6	Alarms and monitoring	60
3.6.1	Definition of terms	60
3.6.2	Device alarm and event handling	60
3.7	Control panel (HMI) lock	63
3.8	Limits lock	63
3.9	Loading and saving a user profile	64
3.10	The function generator	65
3.10.1	Introduction	65

3.10.2	General.....	65
3.10.3	Method of operation.....	66
3.10.4	Manual operation	66
3.10.5	Sine wave function.....	67
3.10.6	Triangular function	68
3.10.7	Rectangular function.....	68
3.10.8	Trapezoidal function.....	69
3.10.9	DIN 40839 function	69
3.10.10	Arbitrary function	70
3.10.11	Ramp function.....	74
3.10.12	UI and IU table functions (XY table).....	74
3.10.13	Battery test function	76
3.10.14	MPP tracking function.....	78
3.10.15	Remote control of the function generator....	80
3.11	Other applications.....	81
3.11.1	Parallel operation in master-slave (MS).....	81
3.11.2	Series connection	84
3.11.3	Two quadrants operation (2QO).....	85

4. SERVICE AND MAINTENANCE

4.1	Maintenance / cleaning.....	87
4.2	Fault finding / diagnosis / repair.....	87
4.2.1	Firmware updates	87
4.3	Calibration	88
4.3.1	Preface	88
4.3.2	Preparation.....	88
4.3.3	Calibration procedure	88

5. CONTACT AND SUPPORT

5.1	Repairs	90
5.2	Contact options	90

1. General

1.1 About this document

1.1.1 Retention and use

This document is to be kept in the vicinity of the equipment for future reference and explanation of the operation of the device. This document is to be delivered and kept with the equipment in case of change of location and/or user.

1.1.2 Copyright

Reprinting, copying, also partially, usage for other purposes as foreseen of this manual are forbidden and breach may lead to legal process.

1.1.3 Validity



This manual is valid for the following devices, including derived variants.

Model	Article nr.	Model	Article nr.	Model	Article nr.
ELR 9080-170 HP	33 200 435	ELR 9200-140 HP	33 200 441	ELR 9360-120 HP	33 200 448
ELR 9200-70 HP	33 200 436	ELR 9360-80 HP	33 200 442	ELR 9500-90 HP	33 200 449
ELR 9360-40 HP	33 200 437	ELR 9500-60 HP	33 200 443	ELR 9750-66 HP	33 200 450
ELR 9500-30 HP	33 200 438	ELR 9750-44 HP	33 200 444	ELR 91000-40 HP	33 200 451
ELR 9750-22 HP	33 200 439	ELR 9080-510 HP	33 200 446	ELR 91500-30 HP	33 200 452
ELR 9080-340 HP	33 200 440	ELR 9200-210 HP	33 200 447		

Changes and modifications for special models will be listed in a separate document.

1.1.4 Symbols and warnings

Warning and safety notices as well as general notices in this document are shown in a box with a symbol as follows:

	Symbol for a life threatening danger
	Symbol for general safety notices (instructions and damage protection bans)
	<i>Symbol for general notices</i>

1.2 Warranty

Intepro Systems guarantees the functional competence of the device within the stated performance parameters. The warranty period begins with the delivery of free from defects equipment.

Terms of guarantee are included in the general terms and conditions of Intepro Systems.

1.3 Limit of liability

All statements and instructions in this manual are based on current norms and regulations, up-to-date technology and our long term knowledge and experience. Intepro Systems accepts no liability for losses due to:

- Usage for purposes other than defined
- Use by untrained personnel
- Rebuilding by the customer
- Technical changes
- Use of non authorized spare parts

The actual delivered device(s) may differ from the explanations and diagrams given here due to latest technical changes or due to customized models with the inclusion of additionally ordered options.

1.4 Disposal of equipment

A piece of equipment which is intended for disposal must, according to local laws and regulations (ElektroG, WEEE) be returned to Intepro Systems for scrapping, unless the person operating the piece of equipment or another, delegated person is conducting the disposal. Our equipment falls under these regulations and is accordingly marked with the following symbol:



1.5 Product key

Decoding of the product description on the label, using an example:

ELR 9 1500 - 30 HP 3U

	Construction (not printed everywhere):
	3U = 19" rack enclosure with 3 units of height
	Version:
	HP = Higher power (compared to series ELR 9000)
	Maximum current of the device in Ampere
	Maximum voltage of the device in Volt
	Series : 9 = Series 9000
	Type identification:
	ELR = Electronic Load with Recovery

1.6 Intended usage

The equipment is intended to be used, if a power supply or battery charger, only as a variable voltage and current source, or, if an electronic load, only as a variable current sink.

Typical application for a power supply is DC supply to any relevant user, for a battery charger the charging of various battery types and for electronic loads the replacement of Ohm resistance by an adjustable DC current sink in order to load relevant voltage and current sources of any type.



- Claims of any sort due to damage caused by non-intended usage will not be accepted.
- All damage caused by non-intended usage is solely the responsibility of the operator.

1.7 Safety**1.7.1 Safety notices****Mortal danger - Hazardous voltage**

- **Electrical equipment operation means that some parts will be under dangerous voltage. Therefore all parts under voltage must be covered!**
- **All work on connections must be carried out under zero voltage (input not connected to voltage sources) and may only be performed by qualified and informed persons. Improper actions can cause fatal injury as well as serious material damage.**
- **This electronic load device uses an inverter and in case of a failure the intermediate circuit voltage can be present on the DC input, even if there is no voltage source connected - it is recommended to never touch the metal parts of the DC input terminals with bare hands!**
- **There also can be dangerous potential between negative DC input to PE or positive DC input to PE due to charged X capacitors, especially after disconnecting a source! This potential only discharges very slowly or not at all!**
- **Always follow 5 safety rules when configuring electric devices:**
 - **Disconnect completely**
 - **Secure against reconnection**
 - **Verify that the system is dead**
 - **Carry out earthing and short-circuiting**
 - **Provide protection from adjacent live parts**



- The equipment must only be used as intended
- The equipment is only approved for use within the connection limits stated on the product label.
- Do not insert any object, particularly metallic, through the ventilator slots
- Avoid any use of liquids near the equipment. Protect the device from wet, damp and condensation.
- For power supplies and battery chargers: do not connect users, particularly low resistance, to devices under power; sparking may occur which can cause burns as well as damage to the equipment and to the user.
- For electronic loads: do not connect power sources to equipment under power, sparking may occur which can cause burns as well as damage to the equipment and to the source.
- ESD regulations must be applied when plugging interface cards or modules into the relative slot
- Interface cards or modules may only be attached or removed after the device is switched off. It is not necessary to open the device.
- Do not connect external power sources with reversed polarity to DC input or outputs! The equipment will be damaged.
- For power supply devices: avoid where possible connecting external power sources to the DC output, and never those that can generate a higher voltage than the nominal voltage of the device.
- For electronic loads: do not connect a power source to the DC input which can generate a voltage more than 120% of the nominal input voltage of the load. The equipment is not protected against over voltage and may be irreparably damaged.
- Never insert a network cable which is connected to Ethernet or its components into the master-slave socket on the back side of the device!
- Always configure the various protecting features against overcurrent, overpower etc. for sensitive sources to what the currently used application requires

1.7.2 Responsibility of the user

The equipment is in industrial operation. Therefore the operators are governed by the legal safety regulations. Alongside the warning and safety notices in this manual the relevant safety, accident prevention and environmental regulations must also be applied. In particular the users of the equipment:

- must be informed of the relevant job safety requirements
- must work to the defined responsibilities for operation, maintenance and cleaning of the equipment
- before starting work must have read and understood the operating manual
- must use the designated and recommended safety equipment.

Furthermore, anyone working with the equipment is responsible for ensuring that the device is at all times technically fit for use.

1.7.3 Responsibility of the operator

Operator is any natural or legal person who uses the equipment or delegates the usage to a third party, and is responsible during its usage for the safety of the user, other personnel or third parties.

The equipment is in industrial operation. Therefore the operators are governed by the legal safety regulations. Alongside the warning and safety notices in this manual the relevant safety, accident prevention and environmental regulations must also be applied. In particular the operator has to

- be acquainted with the relevant job safety requirements
- identify other possible dangers arising from the specific usage conditions at the work station via a risk assessment
- introduce the necessary steps in the operating procedures for the local conditions
- regularly check that the operating procedures are current
- update the operating procedures where necessary to reflect changes in regulation, standards or operating conditions.
- define clearly and unambiguously the responsibilities for operation, maintenance and cleaning of the equipment.
- ensure that all employees who use the equipment have read and understood the manual. Furthermore the users are to be regularly schooled in working with the equipment and the possible dangers.
- provide all personnel who work with the equipment with the designated and recommended safety equipment

Furthermore, the operator is responsible for ensuring that the device is at all times technically fit for use.

1.7.4 User requirements

Any activity with equipment of this type may only be performed by persons who are able to work correctly and reliably and satisfy the requirements of the job.

- Persons whose reaction capability is negatively influenced by e.g. drugs, alcohol or medication may not operate the equipment.
- Age or job related regulations valid at the operating site must always be applied.



Danger for unqualified users

Improper operation can cause person or object damage. Only persons who have the necessary training, knowledge and experience may use the equipment.

Delegated persons are those who have been properly and demonstrably instructed in their tasks and the attendant dangers.

Qualified persons are those who are able through training, knowledge and experience as well as knowledge of the specific details to carry out all the required tasks, identify dangers and avoid personal and other risks.

1.7.5 Alarm signals

The device offers various possibilities for signalling alarm conditions, however, not for danger situations. The signals may be optical (on the display as text) acoustic (piezo buzzer) or electronic (pin/status output of an analog interface). All alarms will cause the device to switch off the DC input.

The meaning of the signals is as follows:

Signal OT (OverTemperature)	<ul style="list-style-type: none"> • Overheating of the device • DC input will be switched off • Non-critical
Signal OVP (OverVoltage)	<ul style="list-style-type: none"> • Overvoltage shutdown of the DC input occurs due to high voltage entering the device • Critical! The device and/or the load could be damaged
Signal OCP (OverCurrent)	<ul style="list-style-type: none"> • Shutdown of the DC input due to excess of the preset limit • Non-critical, protects the source from excessive current drain
Signal OPP (OverPower)	<ul style="list-style-type: none"> • Shutdown of the DC input due to excess of the preset limit • Non-critical, protects the source from excessive power drain
Signal PF (Power Fail)	<ul style="list-style-type: none"> • DC input shutdown due to AC undervoltage or defect in the AC input • Critical on overvoltage! AC mains input circuit could be damaged

1.8 Technical data

1.8.1 Approved operating conditions

- Use only inside dry buildings
- Ambient temperature 0-50 °C
- Operational altitude: max. 2000 m above sea level
- Max. 80% relative humidity, non-condensing

1.8.2 General technical data

Display: Colour TFT touch screen with gorilla glass, 4.3", 480pt x 272pt, capacitive

Controls: 2 rotary knobs with pushbutton functions, 1 button

The nominal values for the device determine the maximum adjustable ranges.

1.8.3 Specific technical data

5 kW	Model HP				
	ELR 9080-170	ELR 9200-70	ELR 9360-40	ELR 9500-30	ELR 9750-20
AC supply					
Voltage	342...528 V				
Phases	2ph, PE				
Frequency	50/60 Hz ±10%				
Efficiency ⁽²⁾	≤ 92.5%	≤ 93.5%	≤ 93.5%	≤ 94.5%	≤ 94.5%
DC Input					
Max. input voltage U_{Max}	80 V	200 V	360 V	500 V	750 V
Max. input power P_{Max}	5 kW	5 kW	5 kW	5 kW	5 kW
Max. input current I_{Max}	170 A	70 A	40 A	30 A	20 A
Overvoltage protection range	$0...1.1 * U_{Max}$	$0...1.1 * U_{Max}$	$0...1.1 * U_{Max}$	$0...1.1 * U_{Max}$	$0...1.1 * U_{Max}$
Overcurrent protection range	$0...1.1 * I_{Max}$	$0...1.1 * I_{Max}$	$0...1.1 * I_{Max}$	$0...1.1 * I_{Max}$	$0...1.1 * I_{Max}$
Overpower protection range	$0...1.1 * P_{Max}$	$0...1.1 * P_{Max}$	$0...1.1 * P_{Max}$	$0...1.1 * P_{Max}$	$0...1.1 * P_{Max}$
Max. allowed input voltage	$1.2 * U_{Nom}$	$1.2 * U_{Nom}$	$1.2 * U_{Nom}$	$1.2 * U_{Nom}$	$1.2 * U_{Nom}$
Min. input voltage for I_{Max}	0.73 V	2.3 V	2.3 V	4.6 V	6.8 V
Input capacitance	ca. 770 µF	ca. 310 µF	ca. 310 µF	ca. 98 µF	ca. 60 µF
Temperature coefficient for set values Δ / K	Voltage / current: 100 ppm				
Voltage regulation					
Adjustment range	0...81.6 V	0...204 V	0...367.2 V	0...510 V	0...765 V
Stability at ΔI	< 0.05% U_{Max}	< 0.05% U_{Max}	< 0.05% U_{Max}	< 0.05% U_{Max}	< 0.05% U_{Max}
Accuracy ⁽¹⁾ (@23±5°C / 73±9°F)	< 0.1% U_{Max}	< 0.1% U_{Max}	< 0.1% U_{Max}	< 0.1% U_{Max}	< 0.1% U_{Max}
Display: Adjustment resolution	see section „1.9.6.4. Resolution of the displayed values“				
Display: Accuracy ⁽³⁾	≤ 0.2%				
Remote sensing compensation	max. 5% U_{Max}				
Current regulation					
Adjustment range	0...173.4 A	0...71.4 A	0...40.8 A	0...30.6 A	0...20.4 A
Stability at ΔU	< 0.15% I_{Max}	< 0.15% I_{Nenn}	< 0.15% I_{Nenn}	< 0.15% I_{Max}	< 0.15% I_{Max}
Accuracy ⁽¹⁾ (@23±5°C / 73±9°F)	< 0.2% I_{Max}	< 0.2% I_{Max}	< 0.2% I_{Max}	< 0.2% I_{Max}	< 0.2% I_{Max}
Display: Adjustment resolution	see section „1.9.6.4. Resolution of the displayed values“				
Display: Accuracy ⁽³⁾	≤ 0.2%				
Compensation 10-90% ΔU_{DC}	< 0.6 ms	< 0.6 ms	< 0.6 ms	< 0.6 ms	< 0.6 ms
Power regulation					
Adjustment range	0...5100 W	0...5100 W	0...5100 W	0...5100 W	0...5100 W
Stability at $\Delta I / \Delta U$	< 0.75% P_{Max}	< 0.75% P_{Max}	< 0.75% P_{Max}	< 0.75% P_{Max}	< 0.75% P_{Max}
Accuracy ⁽¹⁾ (@23±5°C / 73±9°F)	< 1% P_{Max}	< 1% P_{Max}	< 1% P_{Max}	< 1% P_{Max}	< 1% P_{Max}
Display: Adjustment resolution	see section „1.9.6.4. Resolution of the displayed values“				
Display: Accuracy ⁽³⁾	≤ 0.2%				
Resistance regulation					
Adjustment range	0.02...25 Ω	0.1...150 Ω	0.3...520 Ω	0.5...1000 Ω	1.2...2200 Ω
Accuracy ⁽⁴⁾ (@23±5°C / 73±9°F)	≤ 1% of max. resistance ± 0.3% of rated current				
Display: Adjustment resolution	see section „1.9.6.4. Resolution of the displayed values“				

(1) Related to the nominal values, the accuracy defines the maximum deviation between an adjusted value and the true (actual) value on the DC input.
Example: a 170 A model has min. 0.4% current accuracy, that calculates as 680 mA. When adjusting the current to 80 A, the actual current on the DC input is allowed to differ by a maximum of 680 mA, which means it may be between 79.32 A and 80.68 A.

(2) Typical value at 100% input voltage and 100% power

(3) The display accuracy adds to the accuracy of the related actual value on the DC input, so the display accuracy will be lower, i.e. the error will be higher

(4) Includes the accuracy of the displayed actual value

5 kW	Model HP				
	ELR 9080-170	ELR 9200-70	ELR 9360-40	ELR 9500-30	ELR 9750-20
Analog interface ⁽¹⁾					
Set value inputs	U, I, P, R				
Actual value output	U, I				
Control signals	DC input on/off, remote control on/off, R mode on/off				
Status signals	CV, OVP, OT				
Galvanic isolation to the device	max. 1500 V DC				
Sample rate (set value inputs)	500 Hz				
Insulation	Allowed potential shift (floating voltage) on the DC input:				
Input (DC) to enclosure	±400 V DC	±725 V DC	±725 V DC	±1500 V DC	±1500 V DC
Input (AC) to input (DC)	±400 V DC	±1000 V DC	±1000 V DC	±1800 V DC	±1800 V DC
Environment					
Cooling	Temperature controlled fans				
Ambient temperature	0..50 °C (32...122°F)				
Storage temperature	-20...70 °C (-4...158°F)				
Digital interfaces					
Featured	1x USB-B for communication, 1x USB-A for functions and logging, 1x Master-slave bus, 1x GPIB (optional)				
Interface modules slot ⁽²⁾	optional: CANopen, Profibus, Profinet, RS232, CAN, Ethernet, ModBus TCP, EtherCAT				
Galvanic isolation to the device	max. 1500 V DC				
Terminals					
Rear side	Share Bus, DC input, AC input/output, remote sensing, analog interface, USB-B, master-slave bus, Interface module slot				
Front side	USB-A				
Dimensions					
Enclosure (WxHxD)	19" x 3U x 668 mm (26.3")				
Total (WxHxD)	483 mm x 133 mm x 775 mm (19" x 5.2" x 30.5")				
Standards	EN 61010-1:2011-07, EN 50160:2011-02 (grid class 2), EN 61000-6-2:2016-05, EN 61000-6-3:2011-09 (radiation class B)				
Weight	~18 kg (39.7 lb)	~18 kg (39.7 lb)	~18 kg (39.7 lb)	~18 kg (39.7 lb)	~18 kg (39.7 lb)
Article number ⁽³⁾	33200435	33200436	33200437	33200438	33200439

(1) For technical specifications of the analog interface see „3.5.4.4 Analog interface specification“ on page 57

(2) Only in the standard version

(3) Article number of the standard version, devices with options will have a different number

10 kW	Model HP				
	ELR 9080-340	ELR 9200-140	ELR 9360-80	ELR 9500-60	ELR 9750-40
AC supply					
Voltage	342...528 V				
Phases	3ph, PE				
Frequency	50/60 Hz ±10%				
Efficiency ⁽²⁾	≤ 92.5%	≤ 93.5%	≤ 93.5%	≤ 94.5%	≤ 94.5%
DC Input					
Max. input voltage U_{Max}	80 V	200 V	360 V	500 V	750 V
Max. input power P_{Max}	10 kW	10 kW	10 kW	10 kW	10 kW
Max. input current I_{Max}	340 A	140 A	80 A	60 A	40 A
Oversvoltage protection range	$0...1.1 * U_{Max}$	$0...1.1 * U_{Max}$	$0...1.1 * U_{Max}$	$0...1.1 * U_{Max}$	$0...1.1 * U_{Max}$
Overcurrent protection range	$0...1.1 * I_{Max}$	$0...1.1 * I_{Max}$	$0...1.1 * I_{Max}$	$0...1.1 * I_{Max}$	$0...1.1 * I_{Max}$
Overpower protection range	$0...1.1 * P_{Max}$	$0...1.1 * P_{Max}$	$0...1.1 * P_{Max}$	$0...1.1 * P_{Max}$	$0...1.1 * P_{Max}$
Max. allowed input voltage	$1.2 * U_{Nom}$	$1.2 * U_{Nom}$	$1.2 * U_{Nom}$	$1.2 * U_{Nom}$	$1.2 * U_{Nom}$
Min. input voltage for I_{Max}	0.73 V	2.3 V	2.3 V	4.6 V	6.9 V
Input capacitance	ca. 1540 µF	ca. 620 µF	ca. 620 µF	ca. 196 µF	ca. 120 µF
Temperature coefficient for set values Δ / K	Voltage / current: 100 ppm				
Voltage regulation					
Adjustment range	0...81.6 V	0...204 V	0...367.2 V	0...510 V	0...765 V
Stability at ΔI	< 0.05% U_{Max}	< 0.05% U_{Max}	< 0.05% U_{Max}	< 0.05% U_{Max}	< 0.05% U_{Max}
Accuracy ⁽¹⁾ (@23±5°C / 73±9°F)	< 0.1% U_{Max}	< 0.1% U_{Max}	< 0.1% U_{Max}	< 0.1% U_{Max}	< 0.1% U_{Max}
Display: Adjustment resolution	see section „1.9.6.4. Resolution of the displayed values“				
Display: Accuracy ⁽³⁾	≤ 0.2%				
Remote sensing compensation	max. 5% U_{Max}				
Current regulation					
Adjustment range	0...346.8 A	0...142.8 A	0...81.6 A	0...61.2 A	0...40.8 A
Stability at ΔU	< 0.15% I_{Max}	< 0.15% I_{Max}	< 0.15% I_{Max}	< 0.15% I_{Max}	< 0.15% I_{Max}
Accuracy ⁽¹⁾ (@23±5°C / 73±9°F)	< 0.2% I_{Max}	< 0.2% I_{Max}	< 0.2% I_{Max}	< 0.2% I_{Max}	< 0.2% I_{Max}
Display: Adjustment resolution	see section „1.9.6.4. Resolution of the displayed values“				
Display: Accuracy ⁽³⁾	≤ 0.2%				
Compensation 10-90% ΔU_{DC}	< 0.6 ms	< 0.6 ms	< 0.6 ms	< 0.6 ms	< 0.6 ms
Power regulation					
Adjustment range	0...10200 W	0...10200 W	0...10200 W	0...10200 W	0...10200 W
Stability at $\Delta I / \Delta U$	< 0.75% P_{Max}	< 0.75% P_{Max}	< 0.75% P_{Max}	< 0.75% P_{Max}	< 0.75% P_{Max}
Accuracy ⁽¹⁾ (@23±5°C / 73±9°F)	< 1% P_{Max}	< 1% P_{Max}	< 1% P_{Max}	< 1% P_{Max}	< 1% P_{Max}
Display: Adjustment resolution	see section „1.9.6.4. Resolution of the displayed values“				
Display: Accuracy ⁽³⁾	≤ 0.2%				
Resistance regulation					
Adjustment range	0.01...13 Ω	0.05...75 Ω	0.15...260 Ω	0.25...500 Ω	0.6...1100 Ω
Accuracy ⁽⁴⁾ (@23±5°C / 73±9°F)	≤1% of max. resistance ± 0.3% of rated current				
Display: Adjustment resolution	see section „1.9.6.4. Resolution of the displayed values“				

(1) Related to the nominal values, the accuracy defines the maximum deviation between an adjusted value and the true (actual) value on the DC input.
Example: a 170 A model has min. 0.4% current accuracy, that calculates as 680 mA. When adjusting the current to 80 A, the actual current on the DC input is allowed to differ by a maximum of 680 mA, which means it may be between 79.32 A and 80.68 A.

(2) Typical value at 100% input voltage and 100% power

(3) The display accuracy adds to the accuracy of the related actual value on the DC input, so the display accuracy will be lower, i.e. the error will be higher

(4) Includes the accuracy of the displayed actual value

10 kW	Model HP				
	ELR 9080-340	ELR 9200-140	ELR 9360-80	ELR 9500-60	ELR 9750-40
Analog interface ⁽³⁾					
Set value inputs	U, I, P, R				
Actual value output	U, I				
Control signals	DC input on/off, remote control on/off, R mode on/off				
Status signals	CV, OVP, OT				
Galvanic isolation to the device	max. 1500 V DC				
Sample rate (set value inputs)	500 Hz				
Insulation	Allowed potential shift (floating voltage) on the DC input:				
Input (DC) to enclosure	±400 V DC	±725 V DC	±725 V DC	±1500 V DC	±1500 V DC
Input (AC) to input (DC)	±400 V DC	±1000 V DC	±1000 V DC	±1800 V DC	±1800 V DC
Environment					
Cooling	Temperature controlled fans				
Ambient temperature	0..50 °C (32...122°F)				
Storage temperature	-20...70 °C (-4...158°F)				
Digital interfaces					
Featured	1x USB-B for communication, 1x USB-A for functions and logging, 1x Master-slave bus, 1x GPIB (optional)				
Interface modules slot ⁽²⁾	optional: CANopen, Profibus, Profinet, RS232, CAN, Ethernet, ModBus TCP, EtherCAT				
Galvanic isolation to the device	max. 1500 V DC				
Terminals					
Rear side	Share Bus, DC input, AC input/output, remote sensing, analog interface, USB-B, master-slave bus, Interface module slot				
Front side	USB-A				
Dimensions					
Enclosure (WxHxD)	19" x 3U x 668 mm (26.3")				
Total (WxHxD)	483 mm x 133 mm x 775 mm (19" x 5.2" x 30.5")				
Standards	EN 61010-1:2011-07, EN 50160:2011-02 (grid class 2), EN 61000-6-2:2016-05, EN 61000-6-3:2011-09 (radiation class B)				
Weight	~25 kg (55.1 lb)	~25 kg (55.1 lb)	~25 kg (55.1 lb)	~25 kg (55.1 lb)	~25 kg (55.1 lb)
Article number ⁽³⁾	33200440	33200441	33200442	33200443	33200444

(1 For technical specifications of the analog interface see „3.5.4.4 Analog interface specification“ on page 57

(2 Only in the standard version

(3 Article number of the standard version, devices with options will have a different number

15 kW	Model HP			
	ELR 9080-510	ELR 9200-210	ELR 9360-120	ELR 9500-90
AC supply				
Voltage	342...528 V			
Phases	3ph, PE			
Frequency	50/60 Hz \pm 10%			
Efficiency ⁽²⁾	\leq 94.5%	\leq 93.5%	\leq 93.5%	\leq 94.5%
DC Input				
Max. input voltage U_{Max}	80 V	200 V	360 V	500 V
Max. input power P_{Max}	15 kW	15 kW	15 kW	15 kW
Max. input current I_{Max}	510 A	210 A	120 A	90 A
Oversvoltage protection range	$0...1.1 * U_{Max}$	$0...1.1 * U_{Max}$	$0...1.1 * U_{Max}$	$0...1.1 * U_{Max}$
Overcurrent protection range	$0...1.1 * I_{Max}$	$0...1.1 * I_{Max}$	$0...1.1 * I_{Max}$	$0...1.1 * I_{Max}$
Overpower protection range	$0...1.1 * P_{Max}$	$0...1.1 * P_{Max}$	$0...1.1 * P_{Max}$	$0...1.1 * P_{Max}$
Max. allowed input voltage	$1.2 * U_{Nom}$	$1.2 * U_{Nom}$	$1.2 * U_{Nom}$	$1.2 * U_{Nom}$
Min. input voltage for I_{Max}	0.73 V	2.3 V	2.3 V	4.6 V
Input capacitance	ca. 2310 μ F	ca. 930 μ F	ca. 930 μ F	ca. 294 μ F
Temperature coefficient for set values Δ / K	Voltage / current: 100 ppm			
Voltage regulation				
Adjustment range	0...81.6 V	0...204 V	0...367.2 V	0...510 V
Stability at ΔI	$< 0.05\% U_{Max}$	$< 0.05\% U_{Max}$	$< 0.05\% U_{Max}$	$< 0.05\% U_{Max}$
Accuracy ⁽¹⁾ (@23 \pm 5 $^{\circ}$ C / 73 \pm 9 $^{\circ}$ F)	$< 0.1\% U_{Max}$	$< 0.1\% U_{Max}$	$< 0.1\% U_{Max}$	$< 0.1\% U_{Max}$
Display: Adjustment resolution	see section „1.9.6.4. Resolution of the displayed values“			
Display: Accuracy ⁽³⁾	$\leq 0.2\%$			
Remote sensing compensation	max. 5% U_{Max}			
Current regulation				
Adjustment range	0...520.2 A	0...214.2 A	0...122.4 A	0...91.8 A
Stability at ΔU	$< 0.15\% I_{Max}$	$< 0.15\% I_{Max}$	$< 0.15\% I_{Max}$	$< 0.15\% I_{Max}$
Accuracy ⁽¹⁾ (@23 \pm 5 $^{\circ}$ C / 73 \pm 9 $^{\circ}$ F)	$< 0.2\% I_{Max}$	$< 0.2\% I_{Max}$	$< 0.2\% I_{Max}$	$< 0.2\% I_{Max}$
Display: Adjustment resolution	see section „1.9.6.4. Resolution of the displayed values“			
Display: Accuracy ⁽³⁾	$\leq 0.2\%$			
Compensation 10-90% ΔU_{DC}	< 0.6 ms	< 0.6 ms	< 0.6 ms	< 0.6 ms
Power regulation				
Adjustment range	0...15300 W	0...15300 W	0...15300 W	0...15300 W
Stability at ΔI / ΔU	$< 0.75\% P_{Max}$	$< 0.75\% P_{Max}$	$< 0.75\% P_{Max}$	$< 0.75\% P_{Max}$
Accuracy ⁽¹⁾ (@23 \pm 5 $^{\circ}$ C / 73 \pm 9 $^{\circ}$ F)	$< 1\% P_{Max}$	$< 1\% P_{Max}$	$< 1\% P_{Max}$	$< 1\% P_{Max}$
Display: Adjustment resolution	see section „1.9.6.4. Resolution of the displayed values“			
Display: Accuracy ⁽³⁾	$\leq 0.2\%$			
Resistance regulation				
Adjustment range	0.006...10 Ω	0.033...50 Ω	0.1...180 Ω	0.16...340 Ω
Accuracy ⁽⁴⁾ (@23 \pm 5 $^{\circ}$ C / 73 \pm 9 $^{\circ}$ F)	$\leq 1\%$ of max. resistance $\pm 0.3\%$ of rated current			
Display: Adjustment resolution	see section „1.9.6.4. Resolution of the displayed values“			

(1) Related to the nominal values, the accuracy defines the maximum deviation between an adjusted value and the true (actual) value on the DC input.
Example: a 170 A model has min. 0.4% current accuracy, that calculates as 680 mA. When adjusting the current to 80 A, the actual current on the DC input is allowed to differ by a maximum of 680 mA, which means it may be between 79.32 A and 80.68 A.

(2) Typical value at 100% input voltage and 100% power

(3) The display accuracy adds to the accuracy of the related actual value on the DC input, so the display accuracy will be lower, i.e. the error will be higher

(4) Includes the accuracy of the displayed actual value

15 kW	Model HP			
	ELR 9080-510	ELR 9200-210	ELR 9360-120	ELR 9500-90
Analog interface ⁽³⁾				
Set value inputs	U, I, P, R			
Actual value output	U, I			
Control signals	DC input on/off, remote control on/off, R mode on/off			
Status signals	CV, OVP, OT			
Galvanic isolation to the device	max. 1500 V DC			
Sample rate (set value inputs)	500 Hz			
Insulation	Allowed potential shift (floating voltage) on the DC input:			
Input (DC) to enclosure	±400 V DC	±725 V DC	±725 V DC	±1500 V DC
Input (AC) to input (DC)	±400 V DC	±1000 V DC	±1000 V DC	±1800 V DC
Environment				
Cooling	Temperature controlled fans			
Ambient temperature	0..50 °C (32...122°F)			
Storage temperature	-20...70 °C (-4...158°F)			
Digital interfaces				
Featured	1x USB-B for communication, 1x USB-A for functions and logging, 1x Master-slave bus, 1x GPIB (optional)			
Interface modules slot ⁽²⁾	optional: CANopen, Profibus, Profinet, RS232, CAN, Ethernet, ModBus TCP, EtherCAT			
Galvanic isolation to the device	max. 1500 V DC			
Terminals				
Rear side	Share Bus, DC input, AC input/output, remote sensing, analog interface, USB-B, master-slave bus, Interface module slot			
Front side	USB-A			
Dimensions				
Enclosure (WxHxD)	19" x 3U x 668 mm (26.3")			
Total (WxHxD)	483 mm x 133 mm x 775 mm (19" x 5.2" x 30.5")			
Standards	EN 61010-1:2011-07, EN 50160:2011-02 (grid class 2), EN 61000-6-2:2016-05, EN 61000-6-3:2011-09 (radiation class B)			
Weight	~32 kg (70.5 lb)	~32 kg (70.5 lb)	~32 kg (70.5 lb)	~32 kg (70.5 lb)
Article number ⁽³⁾	33200446	33200447	33200448	33200449

(1 For technical specifications of the analog interface see „3.5.4.4 Analog interface specification“ on page 57

(2 Only in the standard version

(3 Article number of the standard version, devices with options will have a different number

15 kW	Model HP		
	ELR 9750-60	ELR 91000-40	ELR 91500-30
AC supply			
Voltage	342...528 V		
Phases	3ph, PE		
Frequency	50/60 Hz \pm 10%		
Efficiency ⁽²⁾	\leq 94.5%	\leq 93.5%	\leq 94.5%
DC Input			
Max. input voltage U_{Max}	750 V	1080 V	1500 V
Max. input power P_{Max}	15 kW	15 kW	15 kW
Max. input current I_{Max}	60 A	40 A	30 A
Oversvoltage protection range	$0...1.1 * U_{Max}$	$0...1.1 * U_{Max}$	$0...1.1 * U_{Max}$
Overcurrent protection range	$0...1.1 * I_{Max}$	$0...1.1 * I_{Max}$	$0...1.1 * I_{Max}$
Overpower protection range	$0...1.1 * P_{Max}$	$0...1.1 * P_{Max}$	$0...1.1 * P_{Max}$
Max. allowed input voltage	$1.2 * U_{Nom}$	$1.2 * U_{Nom}$	$1.2 * U_{Nom}$
Min. input voltage for I_{Max}	6.9 V	6.9 V	9.2 V
Input capacitance	ca. 180 μ F	ca. 310 μ F	ca. 33 μ F
Temperature coefficient for set values Δ / K	Voltage / current: 100 ppm		
Voltage regulation			
Adjustment range	0...765 V	0...1101.6 V	0...1530 V
Stability at ΔI	$< 0.05\% U_{Max}$	$< 0.05\% U_{Max}$	$< 0.05\% U_{Max}$
Accuracy ⁽¹⁾ (@23 \pm 5 $^{\circ}$ C / 73 \pm 9 $^{\circ}$ F)	$< 0.1\% U_{Max}$	$< 0.1\% U_{Max}$	$< 0.1\% U_{Max}$
Display: Adjustment resolution	see section „1.9.6.4. Resolution of the displayed values“		
Display: Accuracy ⁽³⁾	$\leq 0.2\%$		
Remote sensing compensation	max. 5% U_{Max}		
Current regulation			
Adjustment range	0...61.2 A	0...40.8 A	0...30.6 A
Stability at ΔU	$< 0.15\% I_{Max}$	$< 0.15\% I_{Max}$	$< 0.15\% I_{Max}$
Accuracy ⁽¹⁾ (@23 \pm 5 $^{\circ}$ C / 73 \pm 9 $^{\circ}$ F)	$< 0.2\% I_{Max}$	$< 0.2\% I_{Max}$	$< 0.2\% I_{Max}$
Display: Adjustment resolution	see section „1.9.6.4. Resolution of the displayed values“		
Display: Accuracy ⁽³⁾	$\leq 0.2\%$		
Compensation 10-90% ΔU_{DC}	< 0.6 ms	< 0.6 ms	< 0.6 ms
Power regulation			
Adjustment range	0...15300 W	0...15300 W	0...15300 W
Stability at ΔI / ΔU	$< 0.75\% P_{Max}$	$< 0.75\% P_{Max}$	$< 0.75\% P_{Max}$
Accuracy ⁽¹⁾ (@23 \pm 5 $^{\circ}$ C / 73 \pm 9 $^{\circ}$ F)	$< 1\% P_{Max}$	$< 1\% P_{Max}$	$< 1\% P_{Max}$
Display: Adjustment resolution	see section „1.9.6.4. Resolution of the displayed values“		
Display: Accuracy ⁽³⁾	$\leq 0.2\%$		
Resistance regulation			
Adjustment range	0.4...740 Ω	0.8...1300 Ω	2.5...3000 Ω
Accuracy ⁽⁴⁾ (@23 \pm 5 $^{\circ}$ C / 73 \pm 9 $^{\circ}$ F)	$\leq 1\%$ of max. resistance $\pm 0.3\%$ of rated current		
Display: Adjustment resolution	see section „1.9.6.4. Resolution of the displayed values“		

(1) Related to the nominal values, the accuracy defines the maximum deviation between an adjusted value and the true (actual) value on the DC input.
Example: a 170 A model has min. 0.4% current accuracy, that calculates as 680 mA. When adjusting the current to 80 A, the actual current on the DC input is allowed to differ by a maximum of 680 mA, which means it may be between 79.32 A and 80.68 A.

(2) Typical value at 100% input voltage and 100% power

(3) The display accuracy adds to the accuracy of the related actual value on the DC input, so the display accuracy will be lower, i.e. the error will be higher

(4) Includes the accuracy of the displayed actual value

15 kW	Model HP		
	ELR 9750-60	ELR 91000-40	ELR 91500-30
Analog interface ⁽³⁾			
Set value inputs	U, I, P, R		
Actual value output	U, I		
Control signals	DC input on/off, remote control on/off, R mode on/off		
Status signals	CV, OVP, OT		
Galvanic isolation to the device	max. 1500 V DC		
Sample rate (set value inputs)	500 Hz		
Insulation	Allowed potential shift (floating voltage) on the DC input:		
Input (DC) to enclosure	±1500 V DC	±1500 V DC	±1500 V DC
Input (AC) to input (DC)	±1800 V DC	±1800 V DC	±1800 V DC
Environment			
Cooling	Temperature controlled fans		
Ambient temperature	0..50 °C (32...122°F)		
Storage temperature	-20...70 °C (-4...158°F)		
Digital interfaces			
Featured	1x USB-B for communication, 1x USB-A for functions and logging, 1x Master-slave bus, 1x GPIB (optional)		
Interface modules slot ⁽²⁾	optional: CANopen, Profibus, Profinet, RS232, CAN, Ethernet, ModBus TCP, EtherCAT		
Galvanic isolation to the device	max. 1500 V DC		
Terminals			
Rear side	Share Bus, DC input, AC input/output, remote sensing, analog interface, USB-B, master-slave bus, Interface module slot		
Front side	USB-A		
Dimensions			
Enclosure (WxHxD)	19" x 3U x 669 mm (26.3")		
Total (WxHxD)	483 mm x 133 mm x 775 mm (19" x 5.2" x 30.5")		
Standards	EN 61010-1:2011-07, EN 50160:2011-02 (grid class 2), EN 61000-6-2:2016-05, EN 61000-6-3:2011-09 (radiation class B)		
Weight	~32 kg (70.5 lb)	~32 kg (70.5 lb)	~32 kg (70.5 lb)
Article number ⁽³⁾	33200450	33200451	33200452

(1 For technical specifications of the analog interface see „3.5.4.4 Analog interface specification“ on page 57

(2 Only in the standard version

(3 Article number of the standard version, devices with options will have a different number

1.8.4 Views

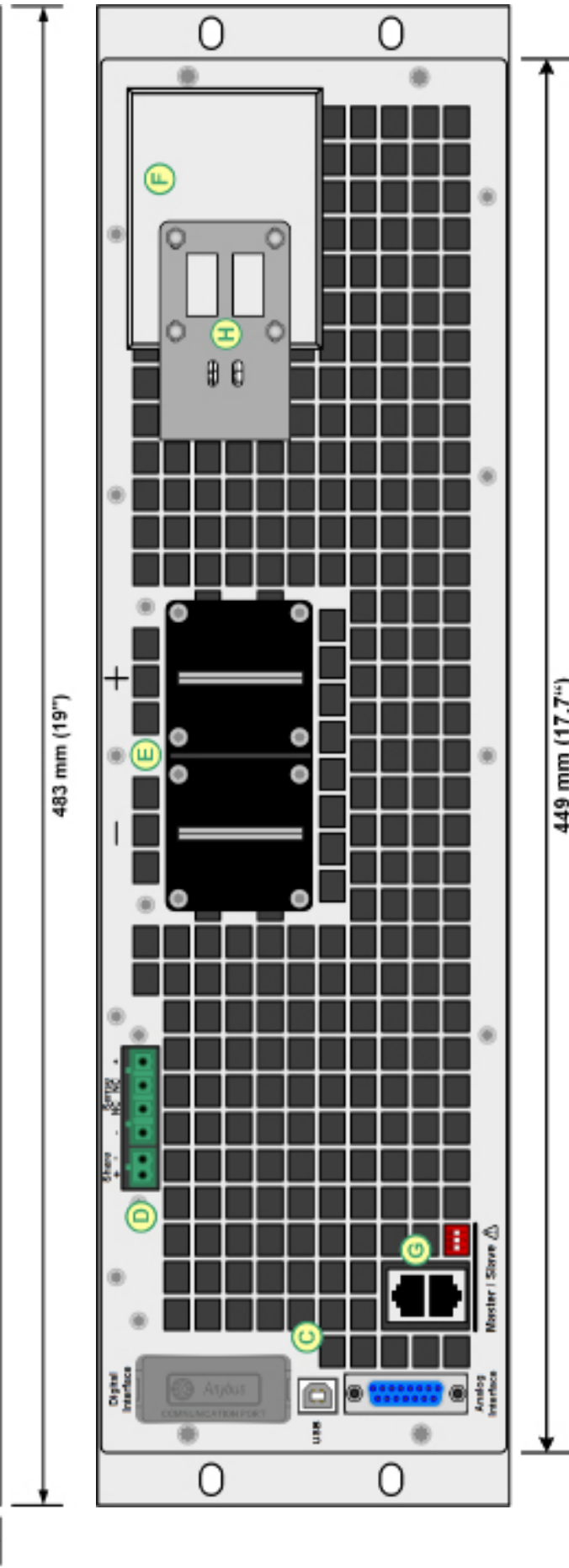
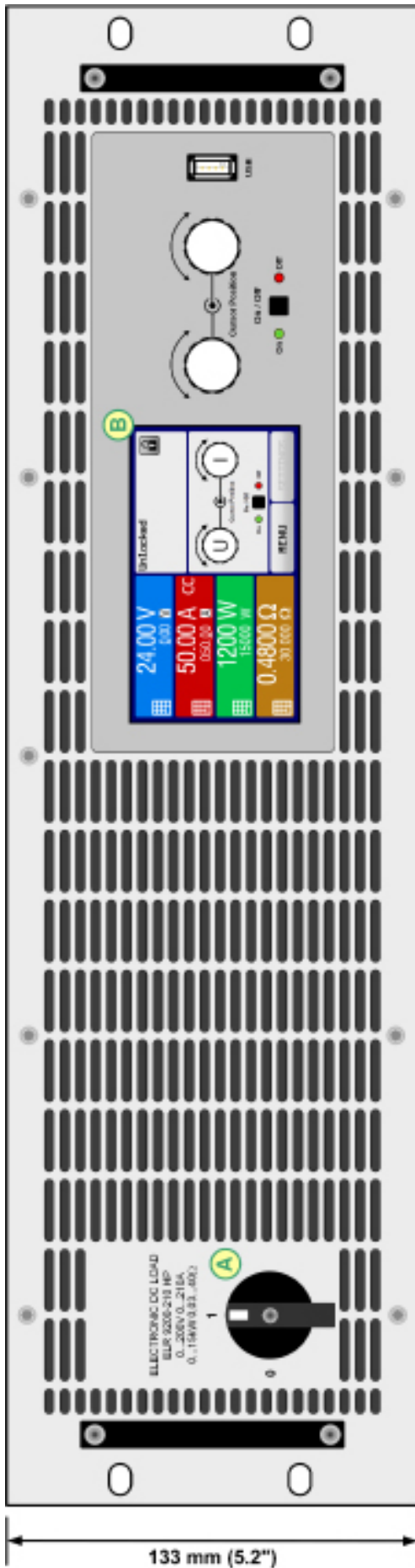

- A - Power switch
- B - Control panel
- C - Control interfaces (digital, analog)
- D - Share Bus and remote sensing connection
- E - DC input (view shows terminal type 1)
- F - AC input/output connector
- G - Master-Slave ports
- H - Plug fixture & strain relief

Figure 1 - Front view

Figure 2 - Rear view of standard version

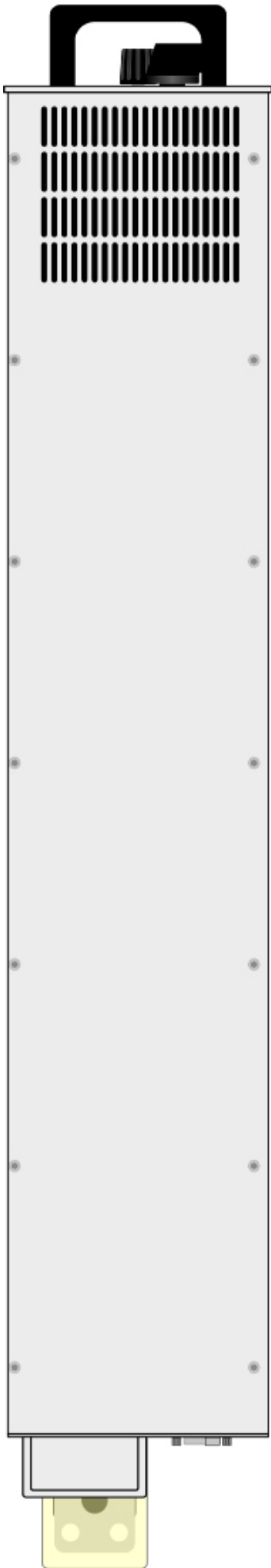

Figure 3 - Left-hand view

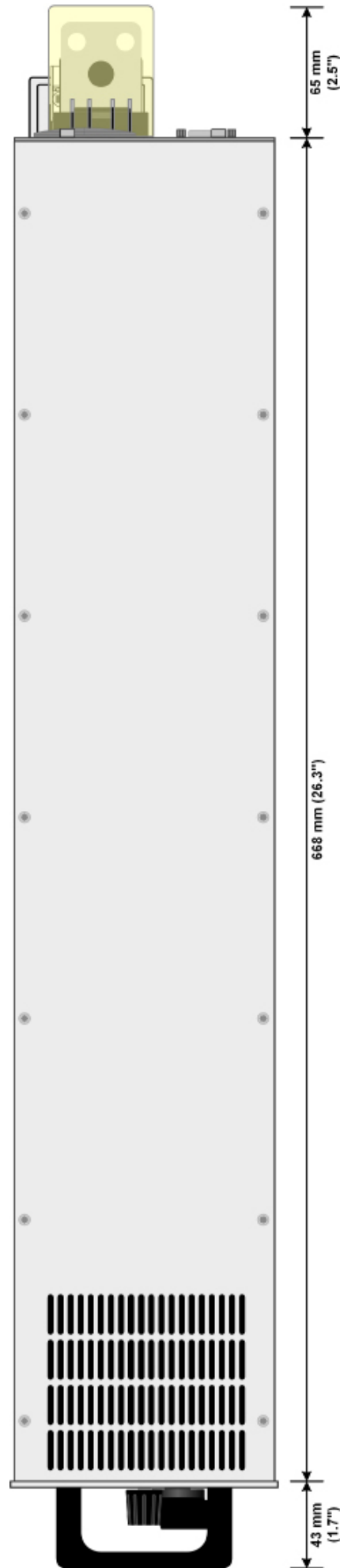

Figure 4 - Right-hand view

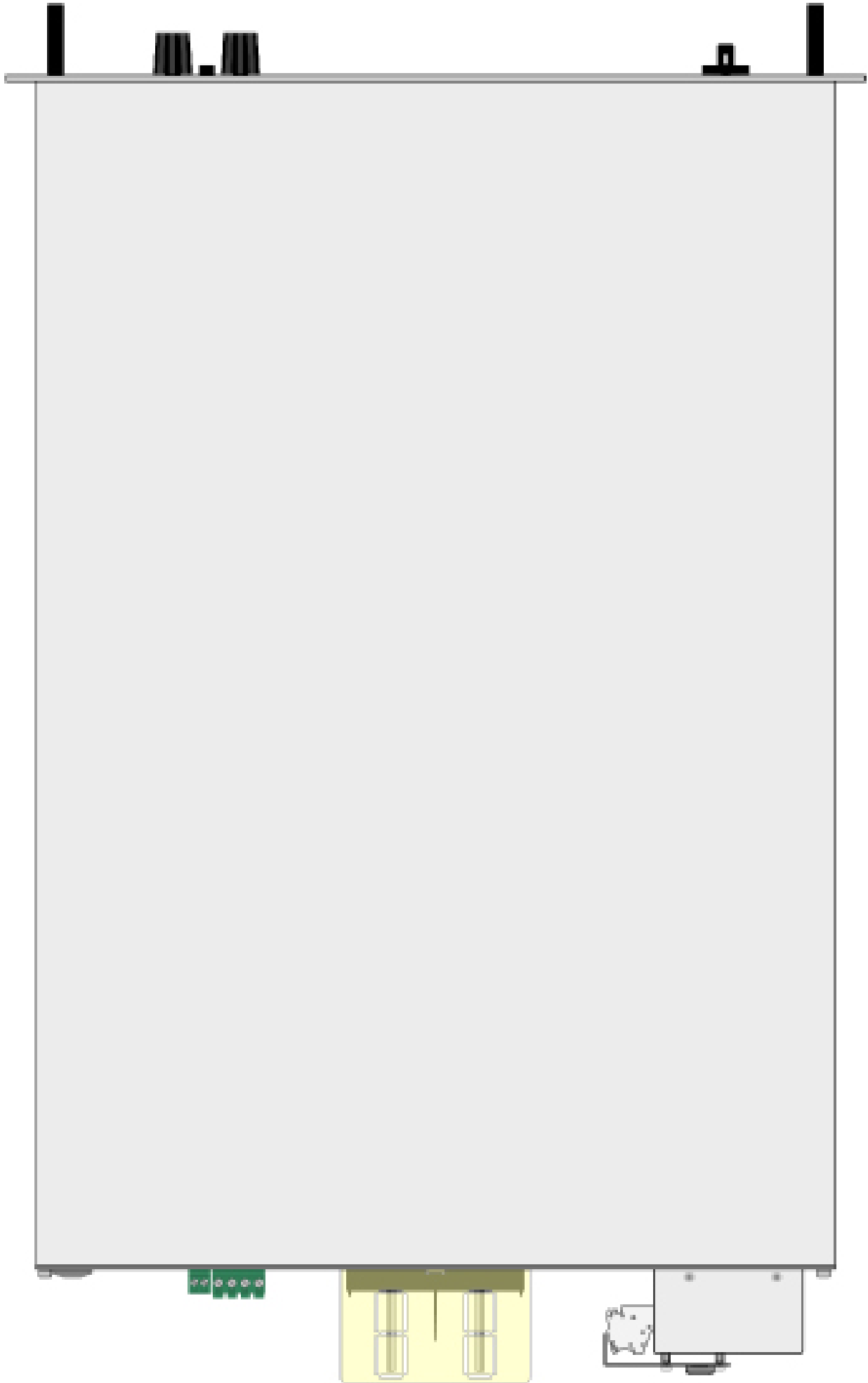

Figure 5 - Top view

1.8.5 Control elements

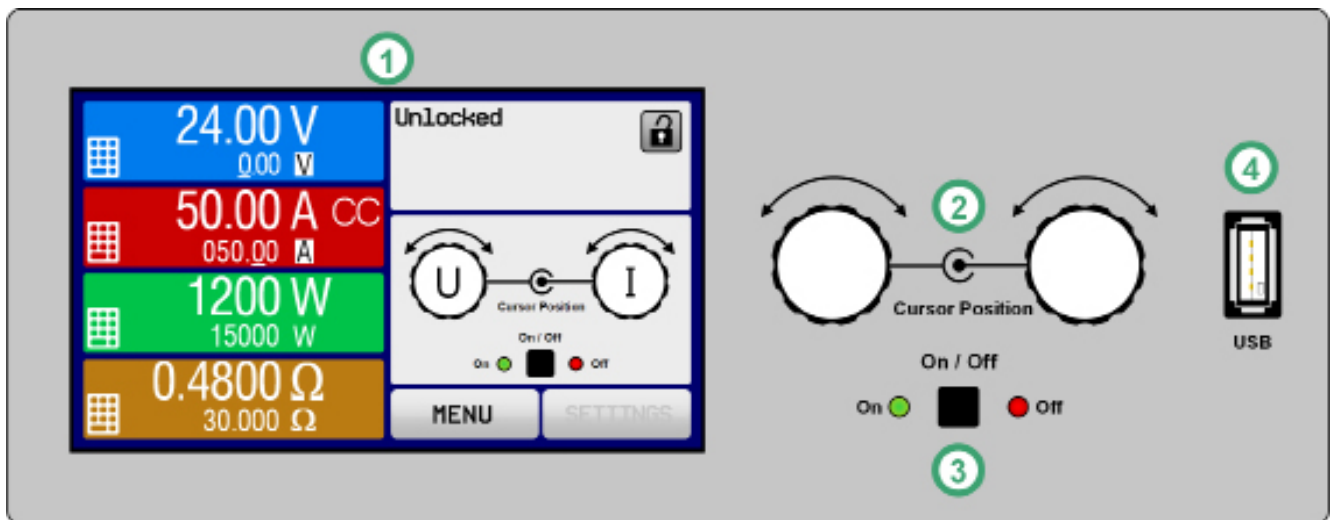

Figure 6 - Control Panel

Overview of the elements on the control panel

For a detailed description see section „1.9.6. The control panel (HMI)“ and „1.9.6.2. Rotary knobs“.

(1)	Touchscreen display Used for selection of set values, menus and settings, as well as display of actual values and status. The touchscreen can be operated with the fingers or with a stylus.
(2)	Rotary knob with push button function Left knob (turn): adjusting the voltage, power or resistance set values, or setting the parameter values in the menu. Left knob (push): selection of the decimal position to be changed (cursor) in the current value selection. Right knob (turn): adjusting the current set value, or setting parameter values in the menu. Right knob (push): selection of the decimal position to be changed (cursor) in the current value selection.
(3)	On/Off Button for DC input Used to toggle the DC input between on and off, also used to start a function run. The LEDs “On” and “Off” indicate the state of the DC input, no matter if the device is manually controlled or remotely
(4)	Port for USB sticks For the connection of standard USB sticks. See section „1.9.6.5. USB port (front side)“ for more details.

1.9 Construction and function

1.9.1 General description

The electronic high performance loads of the ELR 9000 HP series are a progressive development of the ELR 9000 series with higher DC power ratings, new models and a wider AC input range which is now suitable for 380 V, 400 V and 480 V grid voltages.

The devices are especially suitable for test systems and industrial controls due to their compact construction of a 19" enclosure with 3 height units (3U). Apart from basic functions of electronic loads, set point curves can be generated in the integrated function generator (sine, rectangular, triangular and other curve types). Arbitrary curves can be stored on and uploaded from an USB flash drive.

The consumed DC energy is converted through a high efficiency internal inverter and fed back as AC energy into the grid.

For remote control using a PC or PLC the devices are provided as standard with an USB-B slot on the back side as well as a galvanically isolated analog interface.

Via optional plug-in modules other digital interfaces such as RS232, Ethernet, Profibus, ProfiNet, ModBus TCP, CAN, CANopen or EtherCAT can be added. These enable the devices to be connected to standard industrial buses simply by changing or adding a small module. The configuration, if at all necessary, is simple.

In addition, the devices offer as standard the possibility for parallel connection in Share bus operation for constant current sharing plus a genuine master-slave connection with totalling of the slave units' value is also provided as standard. Operating in this way allows up to 16 units to be combined to a single system with a total power of up to 240 kW.

1.9.2 Block diagram

The block diagram illustrates the main components inside the device and their relationships.

There are digital, microprocessor controlled components (KE, DR, HMI), which can be target of firmware updates.

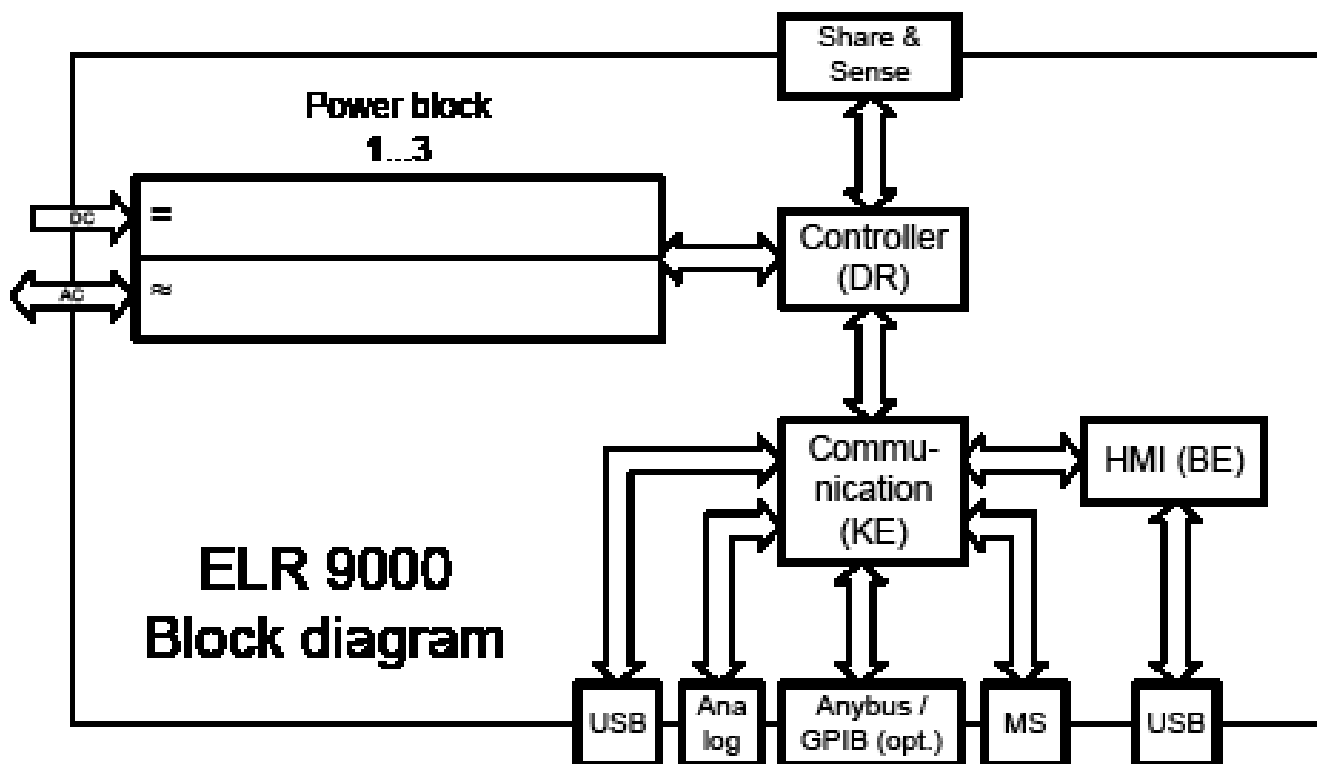

1.9.3 Scope of delivery

- 1 x Electronic load device
- 1 x Share Bus plug
- 1 x Remote sensing plug
- 1 x 1.8 m USB cable
- 1 x Set of DC terminal cover(s)
- 1 x Share/Sense terminal cover (only models from 750 V)
- 1 x USB stick with documentation and software
- 1 x AC connector plug (clamp type)
- 1 x Set for strain relief

1.9.4 Accessories

For these devices the following accessories are available:

Digital interface modules IF-AB	Pluggable and retrofittable digital interface modules for RS232, CANopen, Ethernet, Profibus, ProfiNet, ModBus TCP, CAN or EtherCAT are available. Details about the interface modules and the programming of the device using those interfaces can be found in separate documentation. It is available on the USB stick which comes with the device or as PDF download from the Elektro-Automatik website.
--	---

1.9.5 Options

These options are usually ordered along with the device, as they are permanently built in or preconfigured during the manufacturing process. Retrofitting upon request.

POWER RACKS 19" cabinets	Racks in various configurations up to 42U as parallel systems are available, or mixed with power supply devices to create test systems. Further information in our catalog or upon request
3W GPIB interface	Replaces the standard slot for pluggable interface modules by a rigidly installed GPIB port. This option can be retrofitted upon request. The device will keep the USB and analog interfaces. Via the GPIB port, it can only support SCPI commands.

1.9.6 The control panel (HMI)

The HMI (Human Machine Interface) consists of a display with touchscreen, two rotary knobs, a button and an USB port.

1.9.6.1 Touchscreen display

The graphic touchscreen display is divided into a number of areas. The complete display is touch sensitive and can be operated by finger or stylus to control the device.

In normal operation the left hand side is used to show actual and set values and the right hand side to display status information:

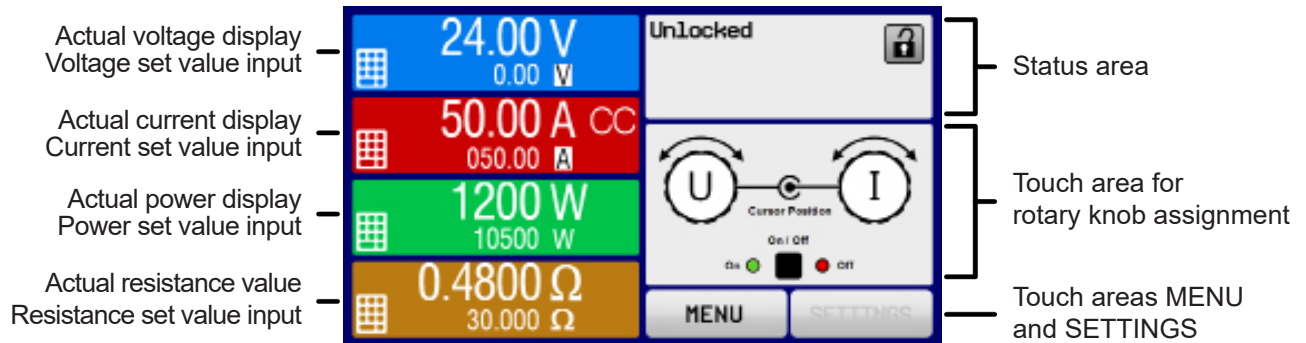

Touch areas may be enabled or disabled:



MENU

Black text or symbol = Enabled

SETTINGS

Grey text or symbol = Disabled

This applies to all touch areas on the main screen and all menu pages..

• Actual / set values area (left hand side)

In normal operation the DC input values (large numbers) and set values (small numbers) for voltage, current and power are displayed. The two resistance related values are only displayed in active resistance mode.

When the DC input is switched on, the actual regulation mode, **CV**, **CC**, **CP** or **CR** is displayed next to the corresponding actual values, as shown in the figure above.

The set values can be adjusted with the rotary knobs next to the display screen or can be entered directly via the touchscreen. When adjusting with the knobs, pushing the knob will select the digit to be changed. Logically, the values are increased by clockwise turning and decreased by anti-clockwise turning.

General display and setting ranges:



Display	Unit	Range	Description
Actual voltage	V	0-125% U_{Nom}	Actual value of DC input voltage
Set value voltage ⁽¹⁾	V	0-100% U_{Nom}	Set value for limiting the DC input voltage
Actual current	A	0.2-125% I_{Nom}	Actual value of DC input current
Set value current ⁽¹⁾	A	0-100% I_{Nom}	Set value for limiting the DC input current
Actual power	W/kW	0-125% P_{Nom}	Calculated actual value of input power, $P = U_{IN} * I_{IN}$
Set value power ⁽¹⁾	W/kW	0-100% P_{Nom}	Set value for limiting DC input power
Actual resistance	Ω	$x^{(2)} \dots 99999 \Omega$	Calculated actual internal resistance, $R = U_{IN} / I_{IN}$
Set value internal resistance ⁽¹⁾	Ω	$x^{(2)} - 100\% R_{Max}$	Set value for the target internal resistance
Adjustment limits	A, V, W/kW	0-102% nom	U-max, I-min etc., related to the physical values
Protection settings	A, V, W/kW	0-110% nom	OVP, OCP etc., related to the physical values

⁽¹⁾ Also valid for values related to these physical quantities, such as OVD for voltage and UCD for current

⁽²⁾ Lower limit for resistance set value varies. See tables in section 1.8.3

• Status display (upper right)

This area displays various status texts and symbols:

Display	Description
Locked	The HMI is locked
Unlocked	The HMI is unlocked
Remote:	The device is under remote control from....
Analogthe built-in analog interface
USB & othersthe built-in USB port or a plug in interface module
Local	The device has been locked by the user explicitly against remote control
Alarm:	Alarm condition which has not been acknowledged or still exists.
Event:	A user defined event has occurred which is not yet acknowledged.
Master	Master-slave mode activated, device is master
Slave	Master-slave mode activated, device is slave
Function:	Function generator activated, function loaded
Stopped / Running	Status of the function generator resp. of the function
 / 	Data logging to USB stick active or failed

• Area for assigning the rotary knobs

The two rotary knobs next to the display screen can be assigned to various functions. This area shows the actual assignments. These can be changed by tapping this area, as long as it's not locked. The display changes to:

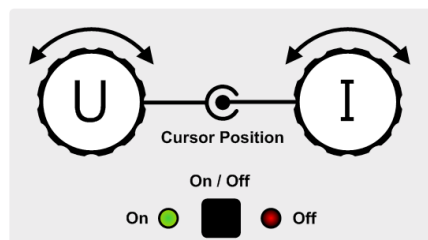

The physical quantities on the depiction of the knobs show the current assignment. With an electronic load, the right-hand knob is always assigned to the current I, while the left knob can be switched by tapping the depiction.

The area will then show the assignment:

U I

Left rotary knob: voltage
Right rotary knob: current

P I

Left rotary knob: power
Right rotary knob: current

R I

Left rotary knob: resistance
Right rotary knob: current

The other set values can't be adjusted via the rotary knobs, unless the assignment is changed. However, values can be entered directly with a ten-key pad by tapping on the small icon . Alternatively to the knob depiction, the assignment can also be changed by tapping the coloured set value areas.

1.9.6.2 Rotary knobs



As long as the device is in manual operation the two rotary knobs are used to adjust set values as well as setting the parameters in the pages SETTINGS and MENU. For a detailed description of the individual functions see section „3.4 Manual operation“ on page 41.

1.9.6.3 Button function of the rotary knobs

The rotary knobs also have a pushbutton function which is used in all menu options for value adjustment to move the cursor by rotation as shown:



1.9.6.4 Resolution of the displayed values

In the display, set values can be adjusted in fixed increments. The number of decimal places depends on the device model. The values have 4 or 5 digits. Actual and set values always have the same number of digits.

Adjustment resolution and number of digits of set values in the display:

Voltage, OVP, UVD, OVD, U-min, U-max			Current, OCP, UCD, OCD, I-min, I-max			Power, OPP, OPD, P-max			Resistance, R-max		
Nominal	Digits	Step width	Nominal	Digits	Step width	Nominal	Digits	Step width	Nominal	Digits	Step width
80 V	4	0.01 V	20 A	5	0.001 A	Normal operation	4	1 W	10 Ω - 75 Ω	5	0.001 Ω
200 V	5	0.01 V	30 A - 90 A	4	0.01 A		5	1 W	150 Ω - 740 Ω	5	0.01 Ω
360 V	4	0.1 V	140 A - 510 A	4	0.1 A	Master-slave <100kW	4	0.01 kW	1000 Ω - 3000 Ω	5	0.1 Ω
500 V	4	0.1 V				Master-slave >100kW	4	0.1 kW			
750 V	4	0.1 V									
1000 V	5	0.1 V									
1500 V	5	0.1 V									

1.9.6.5 USB port (front side)

The frontal USB port, located to the right of the rotary knobs, is intended for the connection of standard USB sticks and can be used for loading or saving sequences for the arbitrary and the XY generator, as well as for logging data.

USB 2.0 sticks are accepted and must be **FAT32** formatted and have a **maximum capacity of 32GB**. USB 3.0 sticks also work, but not from all manufacturers.

All supported files must be held in a designated folder in the root path of the USB drive in order to be found. This folder must be named **HMI_FILES**, such that a PC would recognise the path G:\HMI_FILES if the drive were to be assigned the letter G.

The control panel of the device can read the following file types from a stick:

wave_u<arbitrary_text>.csv	Function generator for an arbitrary function on voltage (U) or current (I)
wave_i<arbitrary_text>.csv	The name must begin with <i>wave_u / wave_i</i> , the rest is user defined.
iu<arbitrary_text>.csv	IU table for the XY function generator. The name must begin with <i>iu</i> , the rest can be user defined.
ui<arbitrary_text>.csv	UI table for the XY function generator. The name must begin with <i>ui</i> , the rest can be user defined.
profile_<nr>.csv	Saved user profile. The number in the file name is a counter and not related to the actual user profile number in the HMI. A max. of 10 files to select from is shown when loading a user profile.
mpp_curve_<arbitrary_text>.csv	User-defined curve data (100 voltage values) for mode MPP4 of the MPPT function

The control panel of the device can save the following file types to an USB stick:

battery_test_log_<nr>.csv	File with log data recorded from the battery test function. For a battery test log, data different and/or additional to log data of normal logging is recorded. The <nr> field in the file name is automatically counted up if equally named files already exist in the folder.
usb_log_<nr>.csv	File with log data recorded during normal operation in all modes. The file layout is identical to the those generated from the Logging feature in EA Power Control. The <nr> field in the file name is automatically counted up if equally named files already exist in the folder.
profile_<nr>.csv	Selected user profile. The number in the file name is a counter and not related to the actual user profile number in the HMI.
wave_u_<nr>.csv wave_i_<nr>.csv	Sequence point data of the arbitrary function generator, according to the current selection of voltage (U) or current (I). Already existing files are listed and can be overwritten.
mpp_result_<nr>.csv	Result data from mode MPP4 (MPPT function) with 100 sets of Umpp, Impp and Pmpp

1.9.7 USB-Port Type B (Back side)

The USB port on the back side of the device is provided for communication with the device and for firmware updates. The included USB cable can be used to connect the device to a PC (USB 2.0 or 3.0). The driver is delivered on the included medium (USB stick) and installs a virtual COM port.

The device can be addressed via this port either using the international standard ModBus RTU protocol or by SCPI language. The device recognises the message protocol used automatically. Details for remote control can be found on the web site of Intepro Systems or on the included medium.

If remote control is in operation the USB port has no priority over either the interface module (see below) or the analog interface and can, therefore, only be used alternatively to these. However, monitoring is always available.

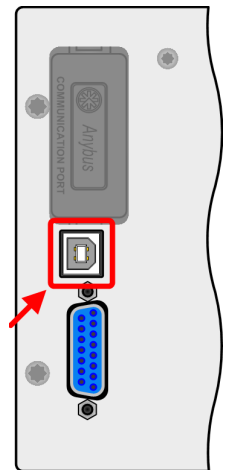

1.9.8 Interface module slot

This slot on the back side of the device (only with standard models, units with option 3W installed are different) is available for various modules of the IF-AB interface series. The following options are available (date: 09-25-2018):

Article number	Name	Description
35400100	IF-AB-CANO	CANopen, 1x Sub-D 9pole male
35400101	IF-AB-RS232	RS 232, 1x Sub-D 9pole male (null modem)
35400103	IF-AB-PBUS	Profibus DP-V1 Slave, 1x Sub-D 9pole female
35400104	IF-AB-ETH1P	Ethernet, 1x RJ45
35400105	IF-AB-PNET1P	ProfiNET IO, 1x RJ45
35400107	IF-AB-MBUS1P	ModBus TCP, 1x RJ45
35400108	IF-AB-ETH2P	Ethernet, 2x RJ45
35400109	IF-AB-MBUS2P	ModBus TCP, 2x RJ45
35400110	IF-AB-PNET2P	ProfiNET IO, 2x RJ45
35400111	IF-AB-CAN	CAN, 1x Sub-D 9pole male
35400112	IF-AB-ECT	EtherCAT, 2x RJ45

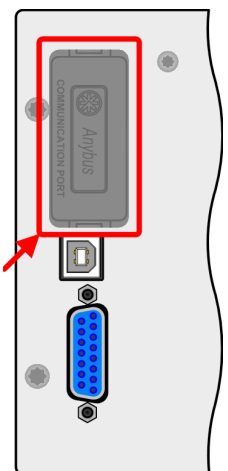

The modules are installed by the user and can be retrofitted without problem. A firmware update of the device may be necessary in order to recognize and support certain modules.

If remote control is in operation the interface module has no priority over either the USB port or the analog interface and can, therefore, only be used alternately to these. However, monitoring is always available.



Switch off device before adding or removing modules!

1.9.9 Analog interface

This 15 pole Sub-D socket on the back side of the device is provided for remote control of the device via analog or digital signals.

If remote control is in operation this analog interface can only be used alternately to the digital interface. However, monitoring is always available.

The input voltage range of the set values and the output voltage range of the monitor values, as well as reference voltage level can be switched in the settings menu of the device between 0-5 V and 0-10 V, in each case for 0-100%.

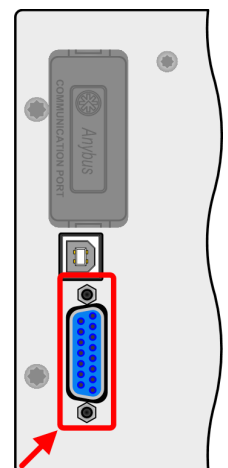

1.9.10 Share connector

The 2 pole socket (“Share”) on the back side of the device is provided for connection to equally named sockets on compatible electronic loads when establishing parallel connection where symmetric current distribution is required, as well as compatible power supplies to build a two-quadrants operation setup. For details about this feature refer to „3.11.1. Parallel operation in master-slave (MS)“ and „3.11.3. Two quadrants operation (2QO)“. Following power supply and electronic load series are compatible:

- PSI 9000 2U - 24U / PSI 9000 3U Slave
- ELR 9000 / ELR 9000 HP / ELR 9000 HP Slave
- EL 9000 B 3U - 24U / EL 9000 B HP / EL 9000 B 2Q
- PSE 9000
- PS 9000 1U / 2U / 3U *

* From hardware revision 2, see type label (in case it does not show “Revision” on type label, it is revision 1)

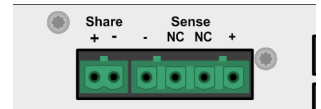

1.9.11 Sense connector (remote sensing)

In order to compensate for voltage drops along the DC cables from the source, the Sense input can be connected to the source. The maximum possible compensation is given in the technical data.

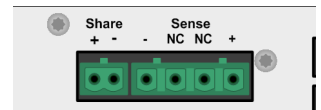

1.9.11.1 Restrictions

Remote sensing is only intended for constant voltage (CV) operation and it is recommended to have the “Sense” input only connected to the source when running the load in CV mode. Primarily in other regulation modes, but also in CV, the sense cables can cause unwanted side effects, like oscillation, based on their length and inductance. Also see 3.2.5.



In order to ensure safety and to comply to international directives, insulation of high voltage models, i. e. such with a nominal voltage of 500 V or higher, is ensured by using only the two outer pins of the 4-pole terminal. The inner two pins, marked with NC, must remain unconnected.

1.9.12 Master-Slave bus

A further port is provided on the back side of the device, comprising two RJ45 sockets, which enables multiple devices of the same model to be connected via a digital bus (RS485) to create a master-slave system. Connection is made using standard CAT5 cables. It can theoretically have a length of up to 1200 m, but it is recommended to keep the connections as short as possible.

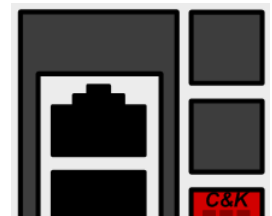

1.9.13 GPIB port (optional)

The optional GPIB connector, which is available with option 3W, will replace the module slot of standard version devices. The device then offers a three-way interface with GPIB, USB and analog.

The connection to a PC or other GPIB port is done with standard GPIB cables from stock, which can have straight or 90° connectors.

When using cable with 90° connectors, the USB port will be inaccessible.

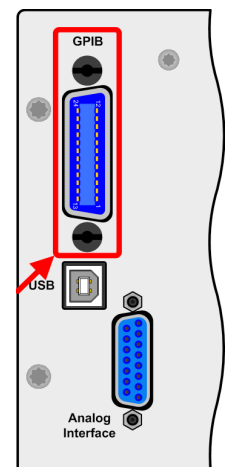

2. Installation & commissioning

2.1 Transport and storage

2.1.1 Transport



- The handles on the front side of the device are **not** for carrying!
- Because of its weight, transport by hand should be avoided where possible. If unavoidable then only the housing should be held and not on the exterior parts (handles, DC input terminal, rotary knobs).
- Do not transport when switched on or connected!
- When relocating the device use of the original packing is recommended
- The device should always be carried and mounted horizontally
- Use suitable safety clothing, especially safety shoes, when carrying the device, as due to its weight a fall can have serious consequences.

2.1.2 Packaging

It is recommended to keep the complete transport packaging for the lifetime of the device for relocation or return to Elektro-Automatik for repair. Otherwise the packaging should be disposed of in an environmentally friendly way.

2.1.3 Storage

In case of long term storage of the device it is recommended to use the original packaging or similar. Storage must be in dry rooms, if possible in sealed packaging, to avoid corrosion, especially internal, through humidity.

2.2 Unpacking and visual check

After every transport, with or without packaging, or before commissioning, the device should be visually inspected for damage and completeness using the delivery note and/or parts list (see section „1.9.3. *Scope of delivery*“). An obviously damaged device (e.g. loose parts inside, damage outside) must under no circumstances be put in operation.

2.3 Installation

2.3.1 Safety procedures before installation and use



- The device may, depending on the model, have a considerable weight. Therefore the proposed location of the device (table, cabinet, shelf, 19" rack) must be able to support the weight without restriction.
- When using a 19" rack, rails suitable for the width of the housing and the weight of the device are to be used. (see „1.8.3. *Specific technical data*“).
- Before connecting to the mains ensure that the supply voltage is as shown on the product label. Overvoltage on the AC supply can cause device damage.
- For electronic loads: Before connecting a voltage source to the DC input make sure, that the source can not generate a voltage higher than specified for a particular model or install measures which can prevent damaging the device by overvoltage input.
- For energy recovering electronic loads: Before connecting the AC input/output to a public grid, it is essential to find out if the operation of this device is allowed at the target location and if it is required to install supervision hardware, i.e. automatic isolation unit (AIU, ENS).

2.3.2 Preparation

Mains connection of an energy back-feeding electronic load of ELR 9000 HP series is done via the included 5 pole plug on the back of the device. Wiring of the plug is at least 3 strand or, for some models, 4 strand of suitable cross section and length. Connecting all conductors (3 phase, N, PE), though not required, is totally acceptable and is even recommended, because the cable could then be used for any other device model or series with the same type of AC connector.

For recommendations for cable cross sections see „2.3.4. Mains connection (AC)“.

Dimensioning of the DC wiring to the voltage source should also reflect the following:



- The cable cross section should always be specified for at least the maximum current of the device.
- Continuous operation at the approved limit generates heat which must be removed, as well as voltage loss which depends on cable length and heating. To compensate for these the cable cross section should be increased and the cable length reduced.

2.3.3 Installing the device



- Select the location for the device so that the connection to the source is as short as possible.
- Leave sufficient space behind the device, minimum 30 cm, for ventilation of warm air that will be exhausted even with devices which feed back up to 90% of the consumed energy.

A device in a 19" housing will usually be mounted on suitable rails and installed in 19" racks or cabinets. The depth of the device and its weight must be taken into account. The handles on the front are for sliding in and out of the cabinet. Slots on the front plate are provided for fixing the device (fixing screws not included).

Acceptable and unacceptable installation positions:

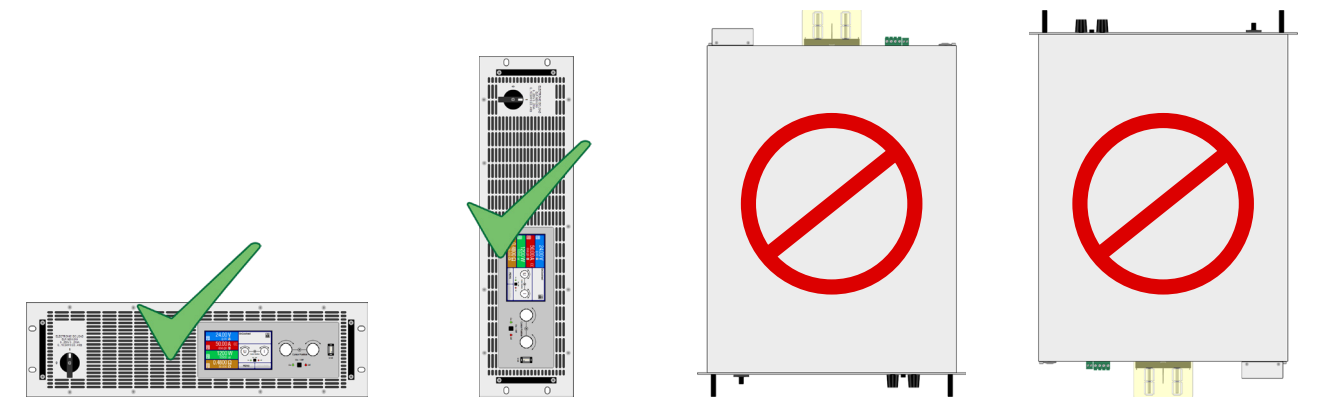

Standing surface

2.3.4 Mains connection (AC)



- Connection to an AC mains supply may only be carried out by qualified personnel!
- Cable cross section must be suitable for the maximum input/output current of the device (see table below)!
- Before plugging in the input plug ensure that the device is switched off by its mains switch!
- Ensure that all regulations for the operation of and connection to the public grid of energy back-feeding equipment have been applied and all necessary conditions have been met!
- When operating multiple ELR units in parallel on the same grid, the cross section of the AC cables has to match the increased output current from the energy recovery

The device is delivered with a 5 pole AC plug. Depending on model, the plug is connected to a 2-phase or 3-phase AC supply, according to the labelling on the plug. Required for the mains connection, with or without grid protection system, are following phases:

	Without grid protection	With grid protection	
Nominal power	Supply connector	Supply connector	Supply type
5000 W	L2, L3, PE	L1, L2, L3, PE	Three-phase
≥10000 W	L1, L2, L3, PE	L1, L2, L3, PE	Three-phase



The PE conductor is imperative and must always be wired!

2.3.4.1 Cross sections

For the selection of a suitable cable **cross section** the rated AC current of the device and the cable length are decisive. Based on the connection of a **single unit** the table lists the maximum input current and recommended minimum cross section for each phase:

Rated power	L1		L2		L3		PE
	∅	I _{max}	∅	I _{max}	∅	I _{max}	∅
5 kW	-	-	1.5 mm ²	13 A	1.5 mm ²	13 A	same as phase
10 kW	2.5 mm ²	23 A	2.5 mm ²	13 A	2.5 mm ²	13 A	same as phase
15 kW	2.5 mm ²	23 A	2.5 mm ²	23 A	2.5 mm ²	23 A	same as phase

2.3.4.2 AC cable

The included connection plug can receive crimped cable ends of up to 6 mm². The longer the connection cable, the higher the voltage loss due to the cable resistance. Therefore the mains cables should be kept as short as possible or have a bigger cross section.

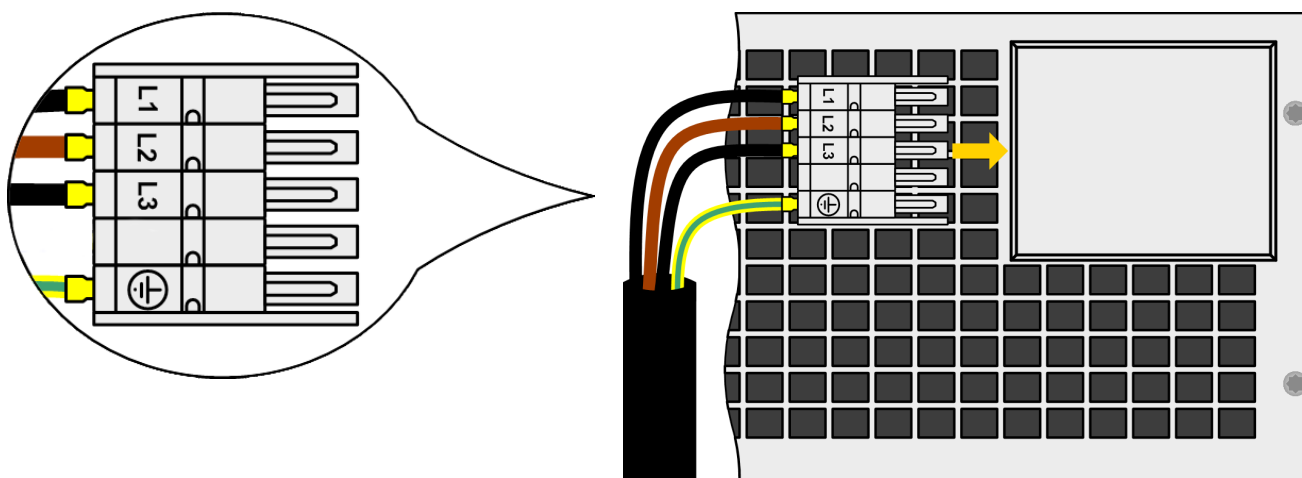

Figure 7 - Example for a supply connection cable (cable not included in the delivery)

2.3.4.3 Strain relief and plug fixture

There is a standard fixture mounted to the AC input connection block on the rear. It is used to prevent the AC plug from loosening and disconnecting due to vibrations or similar. The fixture is also used as strain relief.

Using the 4x M3 acorn nuts, it is recommend to mount the fixture to the AC filter block every time the AC plug has been plugged again.

It is furthermore recommended to install the strain relief by using suitable cable straps (not included), as depicted in the figure to the right.

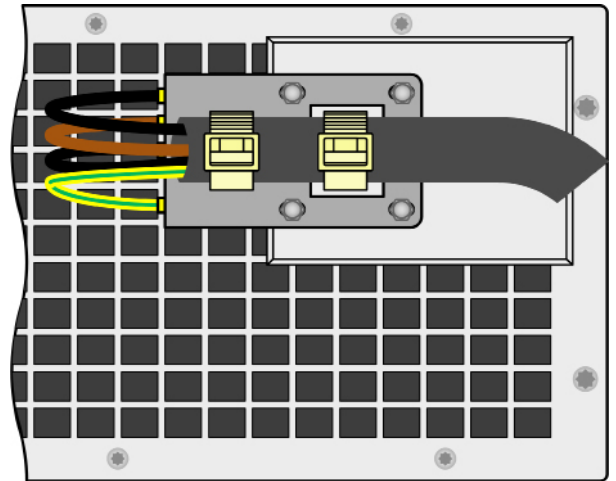

2.3.4.4 Connecting multiple units to one supply

When connecting more than one unit to the same supply point it is recommended to take care for balanced current distribution on the phases. Models with 5 kW rating use two phases, while models with 10 kW or higher rating use all three phases. However, the 10 kW models don't have balanced current on the phases, as you can read from the table in section 2.3.4.

Because the table above shows that phases internally phases L2 and L3 are used to power the 5 kW models. So when connecting multiple units with this power rating to a supply point one would intentionally connect all to L2 and L3, while not using L1 at all. With the 10 kW all three phases are loaded, but not balanced. But when connecting multiple units of identical or different power rating to the same supply point, they could be distributed across all three phases in order to achieve a balanced current distribution as far as possible.

Example depictions:

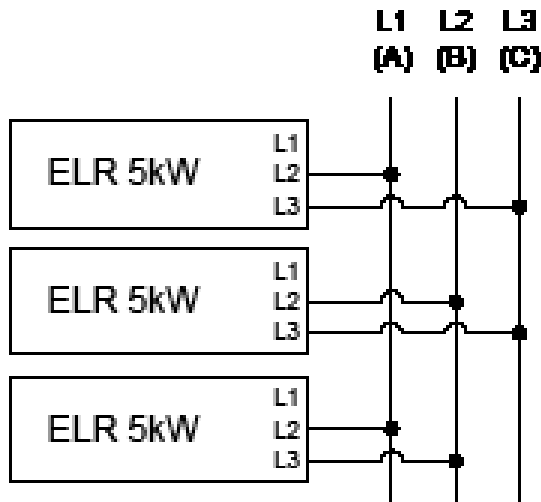

Figure 8 - Example for balanced AC wiring of multiple 5 kW units

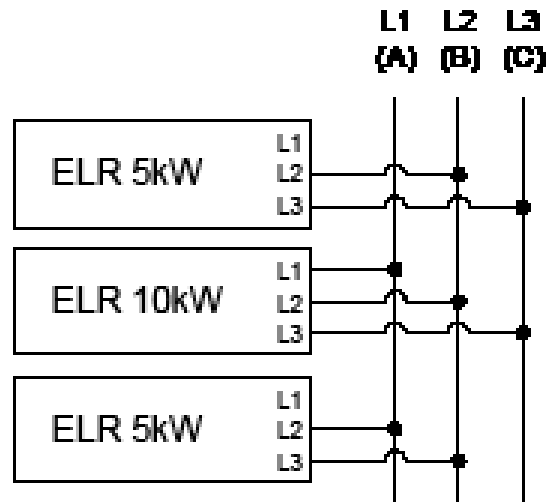

Figure 9 - Example for AC wiring of multiple units with different power ratings and almost balanced current

2.3.4.5 Installation concept for energy recovering devices

The scheme below depicts an often unconsidered problem: the current load of the local electric installation. The devices of series ELR 9000 HP recover energy and feed it back to the local or public grid. The recovered current then adds to the grid current and this can lead to an overload of the existing installation. Considering any two connection points, no matter of what kind, there is usually no extra fusing installed. In case of a defect in the AC part (i.e. short-circuit) of any consumer device or if there are multiple devices connected which could take a higher power, the total current could flow across wires which are not laid out for this higher current. It could lead to damage or even fire in the wires or connection points. This applies to all power ratings.

The existing installation concept must be taken into regard when connecting further units and consumers in order to avoid damages and accidents.

Schematic depiction with 1 recovering load:

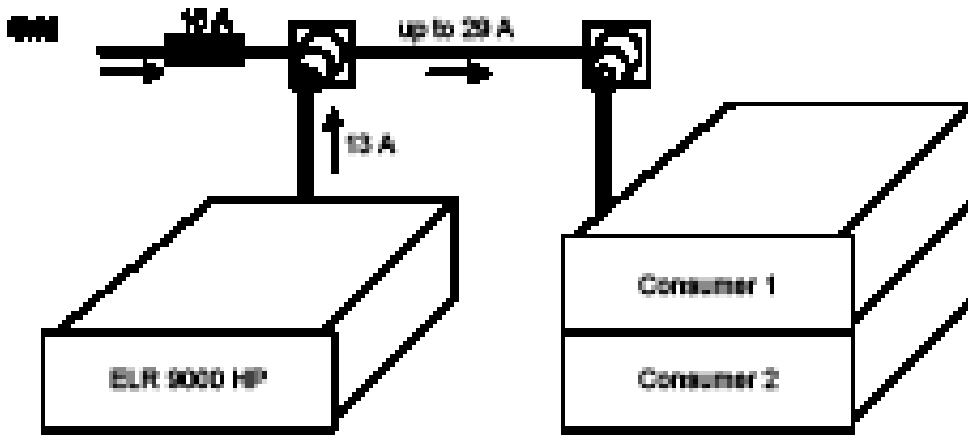

When running a higher number of recovering, i. e. energy backfeeding units on the same leg of the installation, the total currents per phase increases accordingly.

2.3.5 Connection to DC sources



- In the case of a device with a high nominal current and hence a thick and heavy DC connection cable it is necessary to take account of the weight of the cable and the strain imposed on the DC connection. Especially when mounted in a 19" cabinet or similar, where the cable hangs on the DC input, a strain reliever has to be used.
- When powered, the device will always draw a minimum current of 0.1% of the rated current, even when the DC input is switched off. While the DC input is switched on, the set value of current determines the behaviour.

The DC load input is on the back side of the device and is **not** protected by a fuse. The cross section of the connection cable is determined by the current consumption, cable length and ambient temperature.

For cables up to 1.5 m and average ambient temperature up to 50 °C, we recommend:

up to 30 A :	6 mm ²	up to 70 A :	16 mm ²
up to 90 A :	25 mm ²	up to 140 A :	50 mm ²
up to 170 A :	70 mm ²	up to 210 A :	95 mm ²
up to 340 A :	2x70 mm ²	up to 510 A :	2x120 mm ²

per connection pole (multi-conductor, insulated, openly suspended). Single cables of, for example, 70 mm² may be replaced by 2x35 mm² etc. If the cables are long then the cross section must be increased to avoid voltage loss and overheating.

2.3.5.1 DC terminal types

The table below shows an overview of the various DC terminals. It is recommended that connection of load cables always utilizes flexible cables with ring lugs.

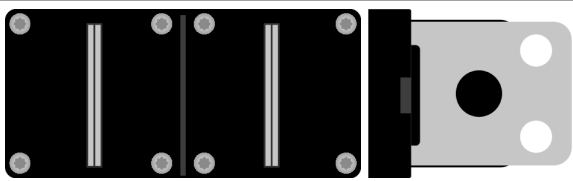
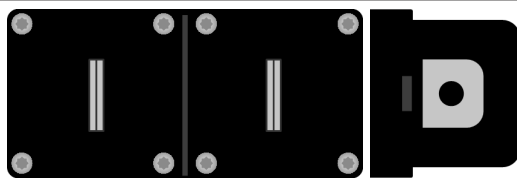
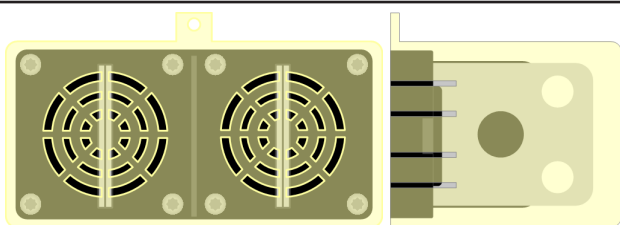
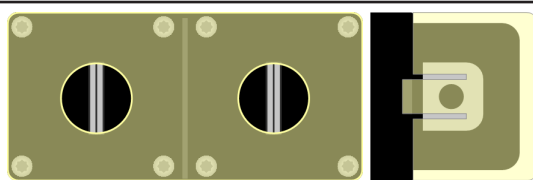
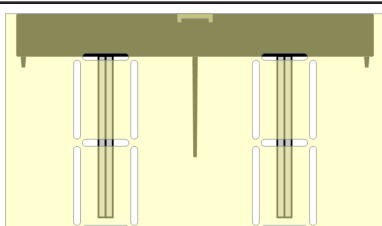
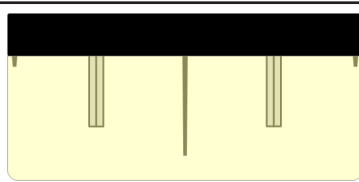
Type 1: Models up to 360 V nominal voltage	Type 2: Models from 500 V nominal voltage
	
M8 bolt on a metal rail Recommendation: ring connector with a 8 mm hole	M6 bolt on a metal rail Recommendation: ring connector with a 6 mm hole
	
	

2.3.5.2 Cable lead and plastic cover

A plastic cover for contact protection is included for the DC terminal. It should always be installed. The cover for type 2 (see picture above) is fixed to the connector itself, for type 1 to the back of the device. Furthermore the cover for type 1 has break outs so that the supply cable can be laid in various directions.



The connection angle and the required bending radius for the DC cable must be taken into account when planning the depth of the complete device, especially when installing in a 19" cabinet or similar. For type 2 connectors only a horizontal lead can be used to allow for installation of the cover.

Examples of the type 1 terminal:

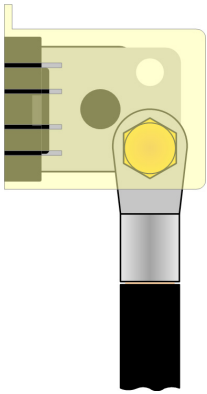

- 90 ° up or down
- space saving in depth
- no bending radius

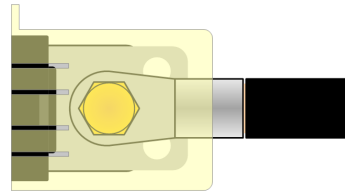

- horizontal lead
- space saving in height
- large bending radius

2.3.6 Grounding of the DC input

Grounding one of the DC output poles is allowed. Doing so can result in a potential shift of the grounded pole against PE.

Because of insulation, there is a max. allowed potential shift of the DC output poles, which also depends on the device model. Refer to „1.8.3. Specific technical data“ for details.



- Digital and analog interface are galvanically isolated from the DC output and should never be grounded, but under no circumstances if any of the DC output poles is grounded too, because this will cancel the galvanic isolation
- If grounding one of the DC output poles check if any pole of the load is already grounded. This could lead to a short circuit!

2.3.7 Connection of remote sensing



Both pins “NC” on the “Sense” terminal must not be connected!



- Remote sensing is only effective during constant voltage operation (CV) and for other regulation modes the sense input should be disconnected if possible, because connecting it generally increases the oscillation tendency.
- The cross section of the sensing cables is noncritical. Recommendation for cables up to 5 m: use at least 0.5 mm². Furthermore, always use cables with suitable specification, especially for the high voltage models
- Sensing cables should be twisted and laid close to the DC cables to damp oscillation. If necessary, an additional capacitor should be installed at the source to eliminate oscillation
- Sensing cables must be connected + to + and - to - at the source, otherwise the sense input of the electronic load can be damaged. For an example see Figure 10 below.
- In master-slave operation, the remote sensing should be connected to the master unit only

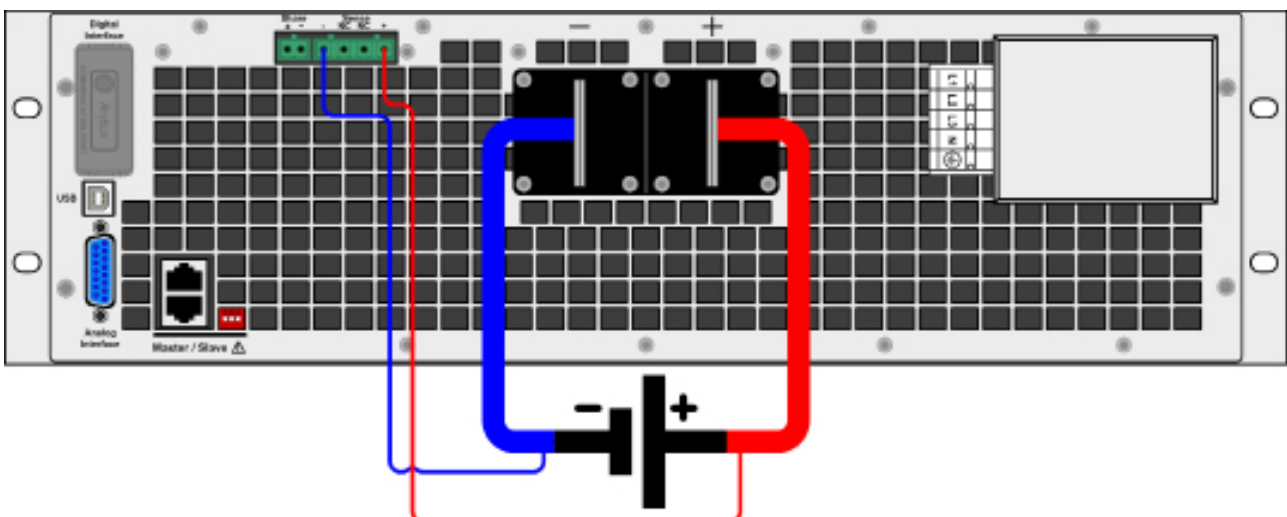

Figure 10 - - Example for remote sensing wiring

2.3.8 Connecting the “Share” bus

The “Share” bus connector on the back side is intended to balance the current of multiple units in parallel operation, especially when using the integrated function generator of the master unit. Alternatively, it can be connected to a compatible power supply, in order to run a two-quadrants operation. For further information about this mode of operation can be found in section „3.11.3. Two quadrants operation (2QO)“.

For the connection of the share bus the following must be paid attention to:



- Connection is only permitted between up to 16 units and only between compatible devices as listed in section „1.9.10. Share connector“
- If a two-quadrants operation system has to be set up where multiple power supplies are connected to one electronic load unit or a group of electronic loads, all units should be connected via Share bus.
- When not using one or several units of a system configured with Share bus, because less power is required for an application, it is recommended to disconnect the unit's from the Share bus, because even when not powered they can have a negative impact on the control signal on the bus due to their impedance. Disconnection can be done by simply unplugging them from the bus or using switches.
- The Share bus is referenced to DC minus. When grounding DC plus, the DC minus will shift its potential and so will the Share bus

2.3.9 Installation of an interface module

The various interface modules, which are available for ELR 9000 HP standard version models with Interface slot, can be retrofitted by the user and are exchangeable with each other. The settings for the currently installed module vary and need to be checked and, if necessary, corrected on initial installation and after module exchange.



- Common ESD protection procedures apply when inserting or exchanging a module!
- The device must be switched off before insertion or removal of a module!
- Never insert any other hardware other than an interface module into the slot!
- If no module is in use it is recommended that the slot cover is mounted in order to avoid internal dirtying of the device and changes in the air flow

Installation steps:

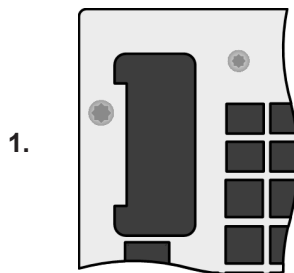

Remove the slot cover. If needed use a screw driver.

Check that the fixing screws of an already installed module are fully retracted. If not, unscrew them (Torx 8) and remove module.

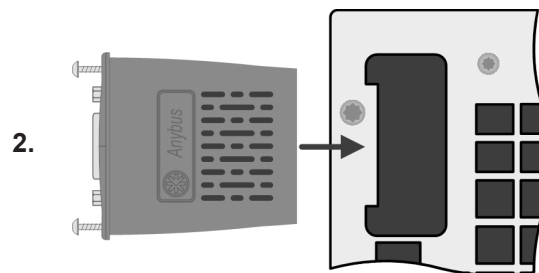

Insert the interface module into the slot. The shape ensures correct alignment.

When inserting take care that it is held as close as possible to a 90 ° angle to the rear wall of the device. Use the green PCB, which you can recognize on the open slot as, as guide. At the end is a socket for the module.

On the underside of the module are two plastic nibs which must click into the green PCB so that the module is properly aligned on the rear wall of the device.

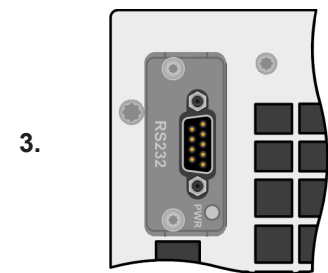

The screws (Torx 8) are provided for fixing the module and should be fully screwed in. After installation, the module is ready for use and can be connected.

Removal follows the reverse procedure. The screws can be used to assist in pulling out the module.

2.3.10 Connecting the analog interface

The 15 pole connector (Type: Sub-D, D-Sub) on the rear side is an analog interface. To connect this to a controlling hardware (PC, electronic circuit), a standard plug is necessary (not included in the scope of delivery). It is generally advisable to switch the device completely off before connecting or disconnecting this connector, but at least the DC input.



The analog interface is galvanically isolated from the device internally. Therefore do not connect any ground of the analog interface (AGND) to the DC minus input as this will cancel the galvanic isolation.

2.3.11 Connecting the USB port (rear side)

In order to remotely control the device via this port, connect the device with a PC using the included USB cable and switch the device on.

2.3.11.1 Driver installation (Windows)

On the initial connection with a PC the operating system will identify the device as new hardware and will try to install a driver. The required driver is for a Communications Device Class (CDC) device and is usually integrated in current operating systems such as Windows 7 or 10. But it is strongly recommended to use and install the included driver installer (on USB stick) to gain maximum compatibility of the device to our softwares.

2.3.11.2 Driver installation (Linux, MacOS)

We cannot provide drivers or installation instructions for these operating systems. Whether a suitable driver is available can be found out by searching the Internet.

2.3.11.3 Alternative drivers

In case the CDC drivers described above are not available on your system, or for some reason do not function correctly, commercial suppliers can help. Search the Internet for suppliers using the keywords "cdc driver windows" or "cdc driver linux" or "cdc driver macos".

2.3.12 Initial commission

For the first start-up after purchasing and installing the device, the following procedures have to be executed:

- Confirm that the connection cables to be used are of a satisfactory cross section!
- Check if the factory settings of set values, safety and monitoring functions and communication are suitable for your intended application of the device and adjust them if required, as described in the manual!
- In case of remote control via PC, read the additional documentation for interfaces and software!
- In case of remote control via the analog interface, read the section in this manual concerning analog interfaces!

2.3.13 Commission after a firmware update or a long period of non use

In case of a firmware update, return of the device following repair or a location or configuration change, similar measures should be taken to those of initial start up. Refer to „2.3.12. Initial commission“.

Only after successful checking of the device as listed may it be operated as usual.

3. Operation and application

3.1 Personal safety



- In order to guarantee safety when using the device, it is essential that only persons operate the device who are fully acquainted and trained in the required safety measures to be taken when working with dangerous electrical voltages
- For models which accept dangerous voltages, the included DC terminal cover, or an equivalent, must always be used
- Whenever the DC input is being re-configured, the device should be disconnected from the mains, not only switched off on the DC input! Also switch off or even disconnect the source!

3.2 Operating modes

An electronic load is internally controlled by different control or regulation circuits, which shall bring voltage, current and power to the adjusted values and hold them constant, if possible. These circuits follow typical laws of control systems engineering, resulting in different operating modes. Every operating mode has its own characteristics which is explained below in short form.

3.2.1 Voltage regulation / Constant voltage

Constant voltage operation (CV) or voltage regulation is a subordinate operating mode of electronic loads. In normal operation, a voltage source is connected to electronic load, which represents a certain input voltage for the load. If the set value for the voltage in constant voltage operation is higher than the actual voltage of the source, the value cannot be reached. The load will then take no current from the source. If the voltage set value is lower than the input voltage then the load will attempt to drain enough current from the source to achieve the desired voltage level. If the resulting current exceeds the maximum possible or adjusted current value or the total power according to $P = U_{IN} * I_{IN}$ is reached, the load will automatically switch to constant current or constant power operation, whatever comes first. Then the adjusted input voltage can no longer be achieved.

While the DC input is switched on and constant voltage mode is active, then the condition “CV mode active” will be shown on the graphics display by the abbreviation CV, as well it will be passed as a signal to the analog interface and stored as internal status which can be read via digital interface.

3.2.1.1 Speed of the voltage controller

The internal voltage controller can be switched between “Slow” and “Fast” (see „3.4.3.1. Menu “General Settings”“). Factory default value is “Slow”. Which setting to select depends on the actual situation in which the device is going to be operated, but primarily it depends of the type of voltage source. An active, regulated source such as a switching mode power supply has its own voltage control circuit which works concurrently to the load’s circuit. Both might work against each other and lead to oscillation. If this occurs it is recommended to set the controller speed to “Slow”.

In other situations, e.g. operating the function generator and applying various functions to the load’s input voltage and setting of small time increments, it might be necessary to set the voltage controller to “Fast” in order to achieve the expected results.

3.2.1.2 Minimum voltage for maximum current

Due to technical reasons, all models in this series have a minimum internal resistance that makes the unit to be provided with a minimum input voltage (U_{MIN}) in order to be able to draw the full current (I_{MAX}). This minimum input voltage varies from model to model and is listed in the technical specifications in 1.8.3. If less voltage than U_{MIN} is supplied, the load proportionally draws less current, which can be calculated easily.

See principle view to the right.

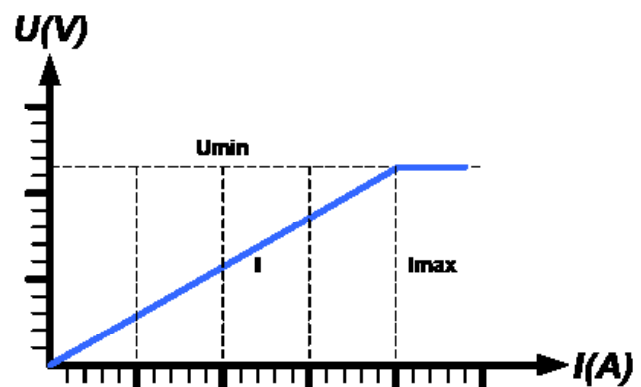

3.2.2 Current regulation / constant current / current limitation

Current regulation is also known as current limitation or constant current mode (CC) and is fundamental to the normal operation of an electronic load. The DC input current is held at a predetermined level by varying the internal resistance according to Ohm's law $R = U / I$ such that, based on the input voltage, a constant current flows. Once the current has reached the adjusted value, the device automatically switches to constant current mode. However, if the power consumption reaches the adjusted power level, the device will automatically switch to power limitation and adjust the input current according to $I_{MAX} = P_{SET} / U_{IN}$, even if the maximum current set value is higher. The current set value, as determined by the user, is always and only an upper limit.

While the DC input is switched on and constant current mode is active, the condition "CC mode active" will be shown on the graphics display by the abbreviation CC, as well it will be passed as a signal to the analog interface and stored as internal status which can be read via digital interface.

3.2.3 Resistance regulation / constant resistance

Inside electronic loads, whose operating principle is based on a variable internal resistance, constant resistance mode (CR) is almost a natural characteristic. The load attempts to set the internal resistance to the user defined value by determining the input current depending on the input voltage according to Ohm's law $I_{IN} = U_{IN} / R_{SET}$. The internal resistance is naturally limited between almost zero and maximum (resolution of current regulation too inaccurate). As the internal resistance cannot have a value of zero, the lower limit is defined to an achievable minimum. This ensures that the electronic load, at very low input voltages, can consume a high input current from the source, up to the maximum.

While the DC input is switched on and constant resistance mode is active, the condition "CR mode active" will be indicated on the graphics display by the abbreviation CR, as well it will be stored as internal status which can be read via digital interface.

3.2.4 Power regulation / constant power / power limitation

Power regulation, also known as power limitation or constant power (CP), keeps the DC input power of the device at the adjusted value, so that the current flowing from the source, together with the input voltage, achieves the desired value. Power limitation then limits the input current according to $I_{IN} = P_{SET} / U_{IN}$ as long as the power source is able to provide this power.

Power limitation operates according to the auto-range principle such that at lower input voltages higher current can flow and vice versa, in order to maintain constant power within the range P_N (see diagram to the right).

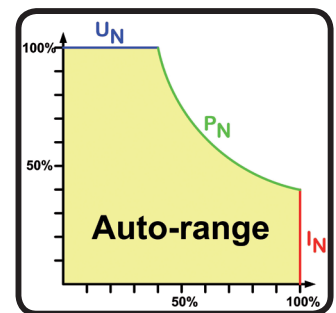

While the DC input is switched on and constant power operation is active, the condition "CP mode active" will be shown on the graphic display by the abbreviation CP, as well it will be stored as internal status which can be read via digital interface.

Constant power operation impacts the internal set current value. This means that the maximum set current may not be reachable if the set power value according to $I = P / U$ sets a lower current. The user defined and displayed set current value is always the upper limit only.

3.2.5 Dynamic characteristics and stability criteria

The electronic load is characterised by short rise and fall times of the current, which are achieved by a high bandwidth of the internal regulation circuit.

In case of testing sources with own regulation circuits at the load, like for example power supplies, a regulation instability may occur. This instability is caused if the complete system (feeding source and electronic load) has too little phase and gain margin at certain frequencies. 180 ° phase shift at > 0dB amplification fulfils the condition for an oscillation and results in instability. The same can occur when using sources without own regulation circuit (eg. batteries), if the connection cables are highly inductive or inductive-capacitive.

The instability is not caused by a malfunction of the load, but by the behaviour of the complete system. An improvement of the phase and gain margin can solve this. In practice, a capacity is directly connected to the DC input of the load. The value to achieve the expected result is not defined and has to be found out. We recommend:

80 V models: 1000uF...4700uF

200 V models: 100uF...470uF

360 V & 500 V models: 47uF...150uF

750 V models: 22uF...100uF

1500 V models: 4.7uF...22uF

3.3 Alarm conditions



This section only gives an overview about device alarms. What to do in case your device indicates an alarm condition is described in section „3.6. Alarms and monitoring“.

As a basic principle, all alarm conditions are signalled optically (text + message in the display), acoustically (if activated) and as a readable status and alarm counter via the digital interface. In addition, the alarms OT, OVP and PF are reported as signals on the analog interface. For later acquisition, an alarm counter can be read from the display or via digital interface.

3.3.1 Power Fail

Power Fail (PF) indicates an alarm condition which may have various causes:

- AC input voltage too low (mains undervoltage, mains failure)
- Defect in the input circuit (PFC)

As soon as a power fail occurs, the device will stop to sink power and switch off the DC input. In case the power fail was an undervoltage and is gone later on, the alarm will vanish from display and doesn't require to be acknowledged.

The condition of the DC input after a gone PF alarm can be determined in the MENU. See 3.4.3.



Switching off the device with the mains switch can not be distinguished from a mains blackout and thus the device will signalise a PF alarm every time the device is switched off. This can be ignored.

3.3.2 Overtemperature

An overtemperature alarm (OT) can occur from an excess temperature inside the device causes it to stop sinking power temporarily. This can occur due to a defect of the internal fan regulation or due to excessive ambient temperature. Though the device recovers most of the consumed energy with a high efficiency, it requires cooling.

After cooling down, the device will automatically continue to work, while the condition of the DC input remains and the alarm doesn't require to be acknowledged.

3.3.3 Overvoltage

An overvoltage alarm (OVP) will switch off the DC input and can occur if:

- the connected voltage source provides a higher voltage to the DC input than set in the overvoltage alarm thresholds (OVP, 0...110% U_{NOM})

This function serves to warn the user of the electronic load acoustically or optically that the connected voltage source has generated an excessive voltage and thereby could damage or even destroy the input circuit and other parts of the device.



The device is not fitted with protection from external overvoltage.

3.3.4 Overcurrent

An overcurrent alarm (OCP) will switch off the DC input and can occur if:

- The input current in the DC input exceeds the adjusted OCP limit.

This function serves to protect the voltage and current source so that this is not overloaded and possibly damaged, rather than offering protection to the electronic load.

3.3.5 Overpower

An overpower alarm (OPP) will switch off the DC input and can occur if:

- the product of the input voltage and input current in the DC input exceeds the adjusted OPP limit.

This function serves to protect the voltage and current source so that this is not overloaded and possibly damaged, rather than offering protection to the electronic load.

3.4 Manual operation

3.4.1 Powering the device

The device should, as far as possible, always be switched on using the rotary switch on the front of the device. Alternatively this can take place using an external cutout (contactor, circuit breaker) of suitable current capacity.

After switching on, the display will first show some device related information (model, firmware versions etc.) and then a language selection screen for 3 seconds.

In setup (see section „3.4.3. Configuration via MENU“ in the second level menu “**General settings**” is an option “**Input after power ON**” in which the user can determine the condition of the DC input after power-up. Factory setting here is “**OFF**”, meaning that the DC input on power-up is always switched off. “**Restore**” means that the last condition of the DC input will be restored, either on or off. All set values are also restored.



For the time of the start phase the analog interface can signal undefined statuses on the output pins such as ERROR or OVP. Those signals must be ignored until the device has finished booting and is ready to work.

3.4.2 Switching the device off

On switch-off, the last input condition and the most recent set values and input status, as well as activated master-slave operation are saved. Furthermore, a PF alarm (power failure) will be reported, but has to be ignored here.

The DC input is immediately switched off and after a short while fans will shut down and after another few seconds the device will be completely powered off.

3.4.3 Configuration via MENU

The MENU serves to configure all operating parameters which are not constantly required. These can be set by finger touch on the MENU touch area, but only if the DC input is switched OFF. See figure to the right.

If the DC input is switched on the settings menu will not be shown, only status information.

Menu navigation is by finger touch. Values are set using the rotary knobs. The assignment of the knobs to the adjustable values is not indicated in menu pages, but there is an assignment rule: upper value -> left-hand knob, lower values -> right-hand knob.

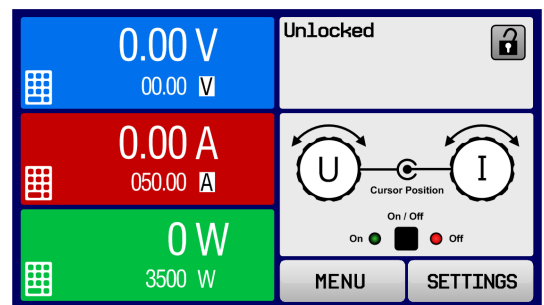

The menu structure is shown schematically on the following pages. Some setting parameters are self-explanatory, others are not. The latter will be explained on the pages following.

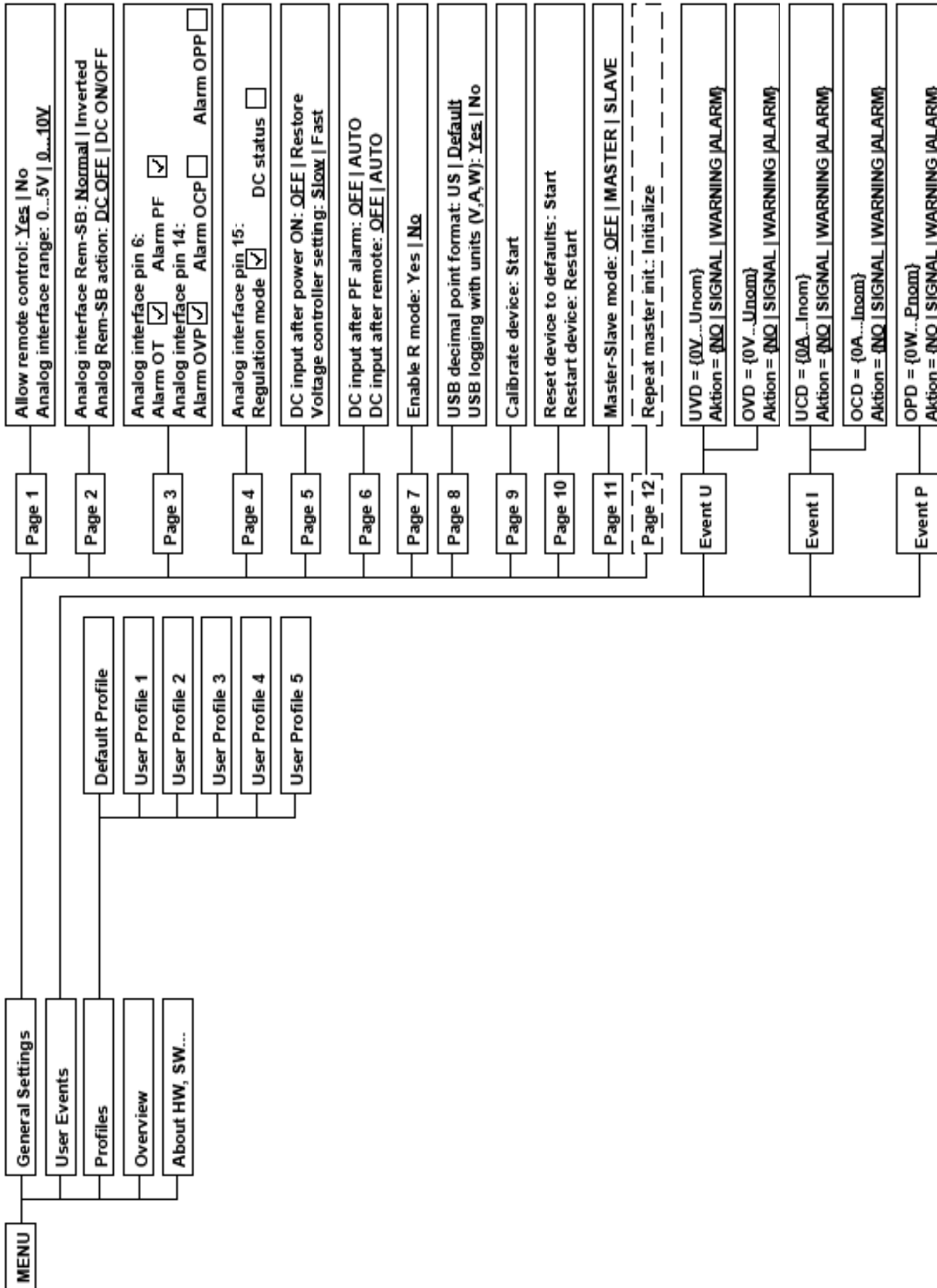

Parameters in curly brackets describe the selectable range, underlined parameters show the default value after delivery or reset.



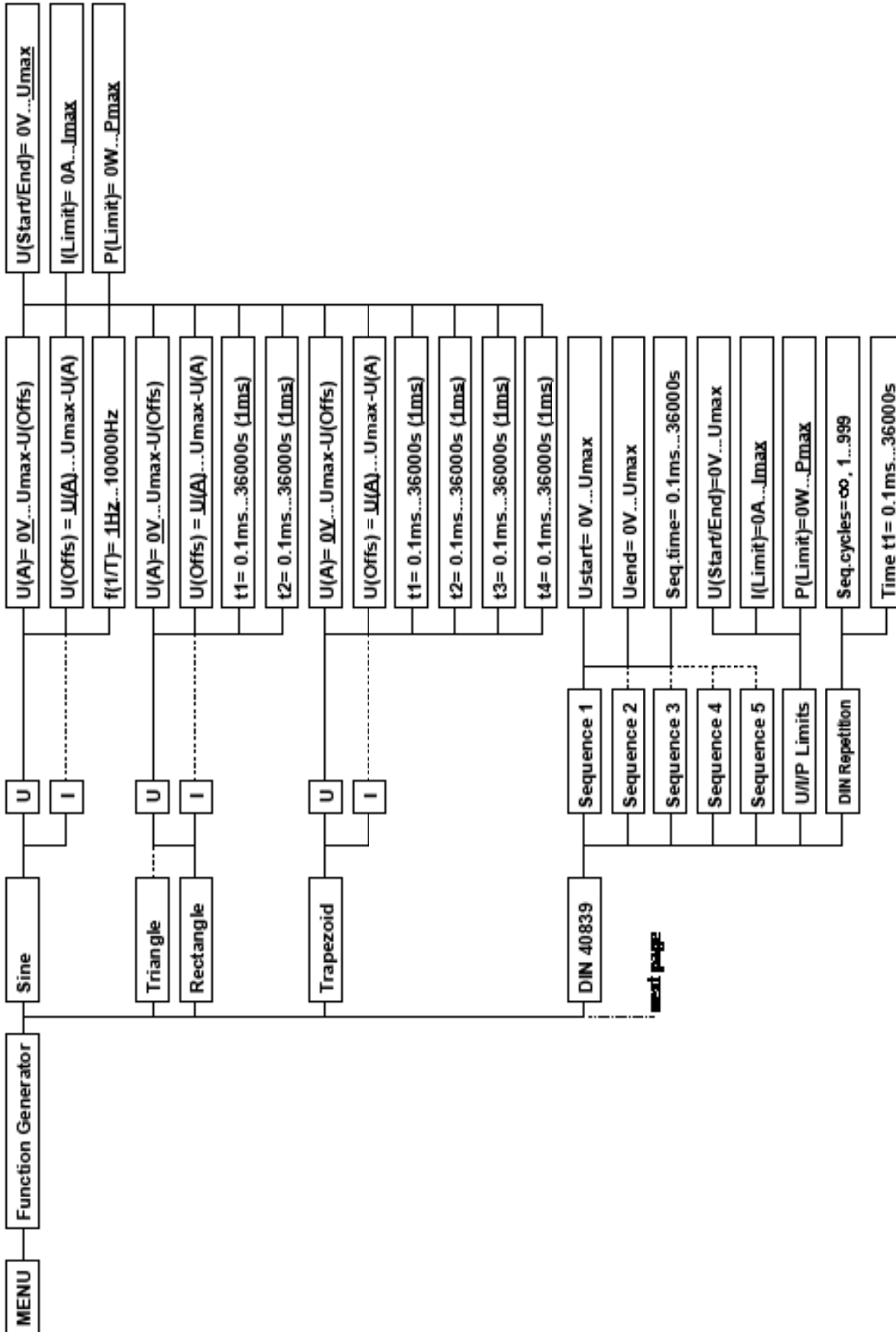

Parameters in curly brackets describe the selectable range, underlined parameters show the default value after delivery or reset. Dotted lines mark multiple identical parameters like with U, I for "Sine", where U(A) changes to I(A) etc.



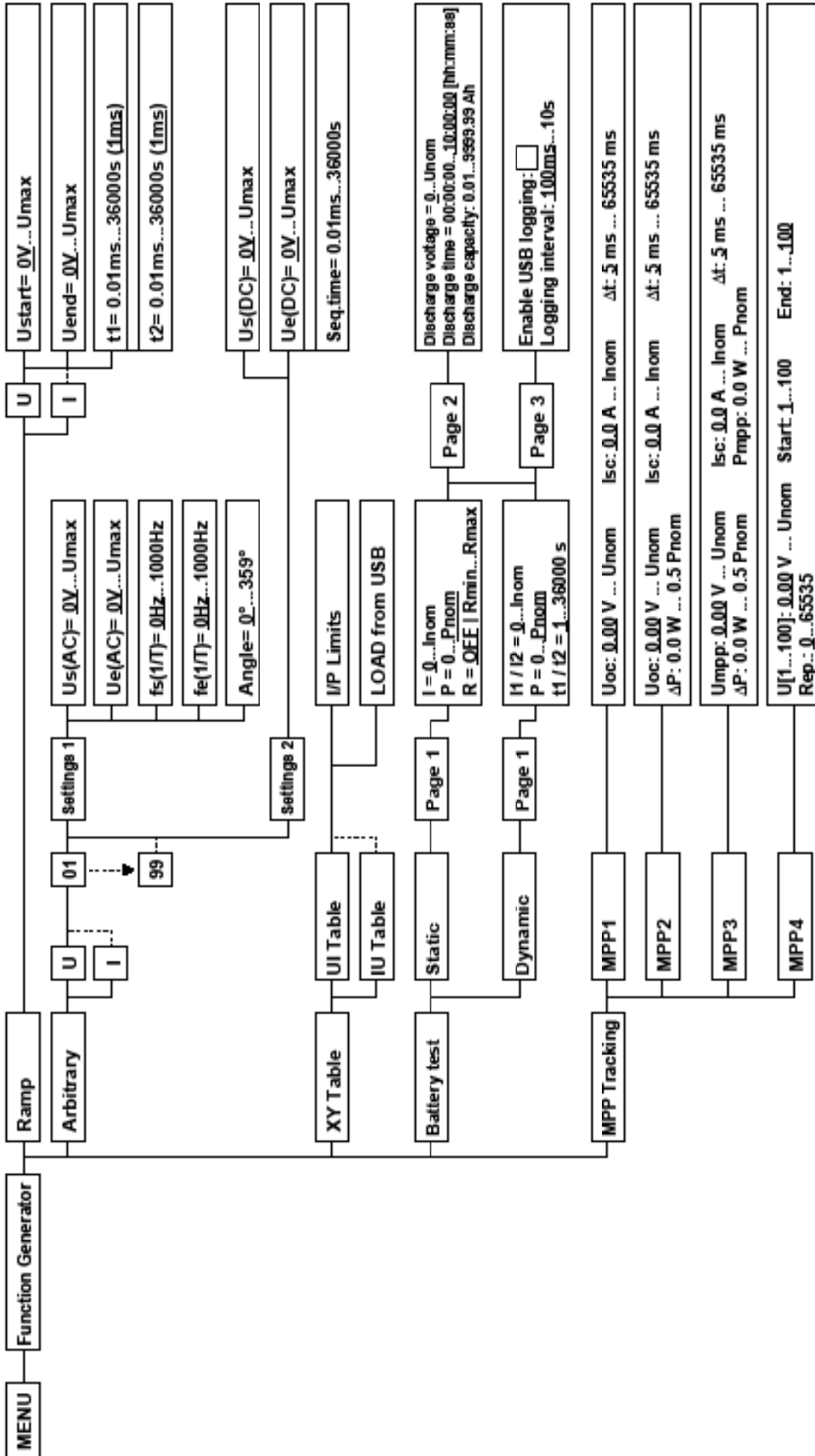

Parameters in curly brackets describe the selectable range, underlined parameters show the default value after delivery or reset. Dotted lines mark multiple identical parameters like with U, I for "Sine", where U(A) changes to I(A) etc.



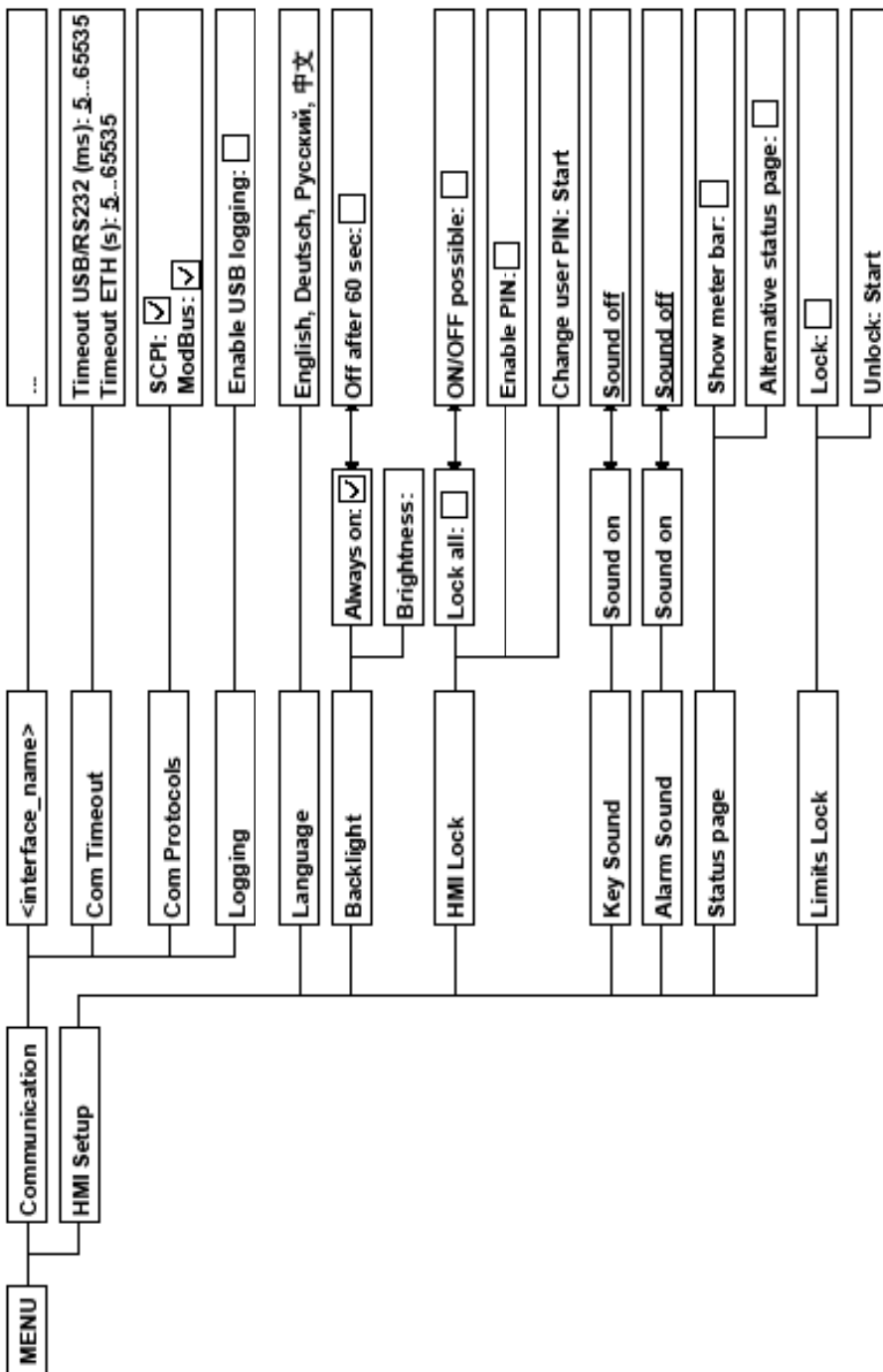

3.4.3.1 Menu "General Settings"

Setting	P.	Description
Allow remote control	1	Selection "NO" means that the device cannot be remotely controlled over either the digital or analog interfaces. If remote control is not allowed, the status will be shown as "Local" in the status area on the main display. Also see section 1.9.6.1
Analog interface range	1	Selects the voltage range for the analog input values, monitoring outputs and reference voltage output. <ul style="list-style-type: none"> • 0...5 V = Range is 0...100% set /actual values, reference voltage 5 V • 0...10 V = Range is 0...100% set /actual values, reference voltage 10 V See also section „3.5.4. Remote control via the analog interface (AI)“
Analog interface Rem-SB	2	Selects how the input pin "Rem-SB" of the analog interface shall be working regarding levels and logic: <ul style="list-style-type: none"> • Normal = Levels and function as described in the table in 3.5.4.4 • Inverted = Levels and function will be inverted Also see „3.5.4.7. Application examples“
Analog Rem-SB action	2	Selects the action on the DC input that is initiated when changing the level of analog input "Rem-SB": <ul style="list-style-type: none"> • DC OFF = the pin can only be used to switch the DC input off • DC AUTO = the pin can be used to switch the DC input off and on again, if it has been switched on before at least from a different control location
Analog interface pin 6	3	Pin 6 of the analog interface (see section 3.5.4.4) is by default assigned to only signal the device alarms OT and PF. This parameter allows to also enable signalling only one of both (3 possible combinations): <p>Alarm OT = Enable/disable signalling of alarm OT on pin 6</p> <p>Alarm PF = Enable/disable signalling of alarm PF on pin 6</p>
Analog interface pin 14	3	Pin 14 of the analog interface (see section 3.5.4.4) is by default assigned to only signal the device alarm OVP. This parameter allows to also enable signalling further device alarms (7 possible combinations): <p>Alarm OVP = Enable/disable signalling of alarm OVP on pin 14</p> <p>Alarm OCP = Enable/disable signalling of alarm OCP on pin 14</p> <p>Alarm OPP = Enable/disable signalling of alarm OPP on pin 14</p>
Analog interface pin 15	4	Pin 15 of the analog interface (see section 3.5.4.4) is by default assigned to only signal the regulation mode CV. This parameter allows to enable signalling a different device status (2 options): <p>Regulation mode = Enable/disable signalling of CV reg mode on pin 15</p> <p>DC status = Enable/disable signalling of DC input status on pin 15</p>
DC input after power ON	5	Determines the condition of the DC input after power-up. <ul style="list-style-type: none"> • OFF = DC input is always off after switching on the device. • Restore = DC input condition will be restored to the condition prior to switch off.
Voltage controller settings	5	Selects the regulation speed of the internal voltage regulator between "Slow" and "Fast". See „3.2.1.1. Speed of the voltage controller“
DC input after PF alarm	6	Determines how the DC input shall react after a power fail (PF) alarm has occurred: <ul style="list-style-type: none"> • OFF = DC input will be switched off and remain until user action • Auto ON = DC input will switch on again after the PF alarm cause is gone and if it was switched on before the alarm occurred
DC input after remote	6	Determines the condition of the DC input after leaving remote control either manually or by command. <ul style="list-style-type: none"> • OFF = DC input will be always off when switching from remote to manual • AUTO = DC input will keep the last condition

Setting	P.	Description
Enable R mode	7	Activates (“Yes”) or deactivates (“No”) the internal resistance control. If activated, the resistance set value can be adjusted on the main screen as additional value. For details refer to „3.2.3. Resistance regulation / constant resistance“
USB file separator format	8	Switches the decimal point format of values and also the CSV file separator for USB logging (see 1.9.6.5 and 3.4.10), as well as for other features where a CSV file can be loaded US = Comma separator (US standard for CSV files) Default = Semicolon separator (german/european standard for CSV files)
USB logging with units (V,A,W)	8	CSV files generated from USB logging by default add physical units to values. This can be deactivated by setting this option to “No”
Calibrate device	9	Touch area “Start” starts a calibration routine (see „4.3. Calibration“), but only if the device is in U/I or P/I mode.
Reset device to defaults	10	Touch area “Start” will initiate a reset of all settings (HMI, profile etc.) to factory default, as shown in the menu structure diagrams on the previous pages
Restart device	10	Will initiate a warm start of the device
Master-Slave mode	11	Option “OFF” (default) disables the master-slave mode (MS), while options MASTER or SLAVE set the device to the selected position. For details about the MS mode see section „3.11.1. Parallel operation in master-slave (MS)“
PSI / ELR system	11	Only displayed if the device has been set to MASTER When activated by finger touch (check mark), it determines that the power supply is part of a two-quadrant operation (see „3.11.3. Two quadrants operation (2QO)“) system and thus it will be master on the Share bus, which is required for a 2QO, because in that mode the power source unit has to be master
Repeat master init.	12	Touch area “Initialize” will repeat the initialisation of the master-slave system in case the automatic enumeration of the slave units by the master is once unsuccessful so the system would have less total power than expected or has to be repeated manually in case the master unit couldn’t detect a missing slave

3.4.3.2 Menu “User Events”

See „3.6.2.1 User defined events“ on page 62.

3.4.3.3 Menu “Profiles”

See „3.9 Loading and saving a user profile“ on page 64.

3.4.3.4 Menu “Overview”

This menu page displays an overview of the set values (U, I, P or U, I, P, R) and alarm settings as well as adjustment limits. These can only be displayed, not changed.

3.4.3.5 Menu “About HW, SW...”

This menu page displays an overview of device relevant data such as serial number, article number etc., as well as an alarm history which lists the number of device alarms that probably occurred since the device has been powered.

3.4.3.6 Menu “Function Generator”

See „3.10 The function generator“ on page 65.

3.4.3.7 Menu “Communication”

This submenu offers global and specific settings for digital communication via the built-in USB interface and the optional modular interfaces of the **IF-AB** series or the optional GPIB port. The button which is labelled with the interface name opens one or more settings pages, depending on the interface in use. There is furthermore an adjustable communication timeout for USB and Ethernet, to make it possible to successfully transfer fragmented messages (data packets) using higher values. In the screen for “Com Protocols” you can enable both or disable one of the two supported communication protocols, ModBus RTU and SCPI. This can help to avoid mixing both protocols and to receive unreadable messages, for example when expecting a SCPI response and getting a Mod-Bus RTU response instead.



For all Ethernet interfaces with two ports: „P1“ is related to port 1 and „P2“ to port 2, like printed on the module face. Two-port interfaces will use one IP only.

IF	Level 1	Description
Profibus DP	Node Address	Selection of the Profibus or node address of the device within range 1...125 via direct input
	Function Tag	String input box for a user-definable text which describes the Profibus slave function tag. Max. length: 32 characters
	Location Tag	String input box for a user-definable text which describes the Profibus slave location tag. Max. length: 22 characters
	Installation Date	String input box for a user-definable text which describes the Profibus slave installation date tag. Max. length: 40 characters
	Description	String input box for a user-definable text which describes the Profibus slave. Max. length: 54 characters

IF	Level 1	Description
RS232	-	The baud rate is selectable, other serial settings can't be changed and are defined like this: 8 data bits, 1 stop bit, parity = none Baud rates: 2400, 4800, 9600, 19200, 38400, 57600, 115200

IF	Level 1	Level 2	Level 3	Description	
Ethernet / ModBus-TCP, 1 & 2 Port	IP Settings 1	DHCP		The IF allows a DHCP server to allocate an IP address, a subnet mask and a gateway. If no DHCP server is in the network then network parameters will be set as defined in point "Manual"	
		Manual	IP address	This option is activated by default. An IP address can be manually allocated.	
			Gateway	Here a gateway address can be allocated if required..	
			Subnet mask	Here a subnet mask can be defined if the default subnet mask is not suitable.	
		DNS address 1 DNS address 2	Here the addresses of the first and second Domain Name Servers (DNS) can be defined, if needed. It helps for easier access to the device's website in browsers when using the user-defined domain		
		Port	Range: 0...65535. Default ports: 5025 = Modbus RTU (all Ethernet interfaces) Reserved ports which must not be set with this parameter: 502 = Modbus TCP (Modbus-TCP interface only) other typical reserved ports		
	IP Settings 2-P1 IP Settings 2-P2	AUTO		Settings for the Ethernet port such as transmission speed are set automatically.	
	Manual	Half duplex	10MBit 100MBit	Full duplex	Manual selection for transmission speed (10MBit/100MBit) and duplex mode (full/half). It is recommended to use the "AUTO" option and only revert to "Manual" if these parameters fail.
		10MBit			
		100MBit			
		100MBit			
	Host name			Free choice of host name (default: Client)	
	Domain name			Free choice of Domain (default: Workgroup)	
TCP Keep-Alive	Enable TCP keep-alive				

IF	Level 1	Level 2	Description
CANopen	Node Address		Selection of the CANopen node address in the range 1...127 via direct input
	Baud Rate	AUTO	Automatic detection of the bus baud rate.(speed)
		LSS	Automatically sets baud rate and node address
		Manual	Manual selection of the baud rate that is used by the CANopen interface. Possible selections: 10 kbps, 20 kbps, 50 kbps, 100 kbps, 125 kbps, 250 kbps, 500 kbps, 800 kbps, 1Mbps (1Mbps = 1 Mbit/s, 10 kbps = 10 kbit/s)

IF	Level 1	Level 2	Level 3	Description
Profinet/IO, 1 & 2 Port	Function Tag	String input box for a user-definable text which describes the Profinet slave function tag. Max. length: 32 characters		
	Location Tag	String input box for a user-definable text which describes the Profinet slave location tag. Max. length: 22 characters		
	Station Name	String input box for a user-definable text which describes the Profinet station name. Max. length: 54 characters		
	Description	String input box for a user-definable text which describes the Profibus slave. Max. length: 54 characters		
	Installation Date	String input box for a user-definable text which describes the Profibus slave installation date tag. Max. length: 40 characters		

IF	Ebene 1	Level 2	Level 3	Description		
CAN	Base ID			Setup of the CAN base ID (11 Bit or 29 Bit, hex format). Default: 0h		
	Baud Rate			Setup of the CAN bus speed or baud rate in typical value between 10 kbps and 1Mbps. Default: 500 kbps		
	Termination			Activates or deactivates CAN bus termination with a built-in resistor. Default: OFF		
	Broadcast ID			Setup of the CAN broadcast ID (11 Bit or 29 Bit, hex format). Default: 7ffh		
	ID Format			Selection of the CAN ID format between Base (11 Bit ID, 0h...7ffh) and Extended (29 Bit, 0h...1fffffffh)		
	Cyclic Communication	Base ID Cyclic Read			Setup of the CAN base ID (11 Bit or 29 Bit, hex format) for cyclic read of up to 5 object groups (see " Cyclic Read Timing "). The device will automatically send specific object data to the IDs defined with this setting. For more information refer to the programming guide. Default: 100h	
			Base ID Cyclic Send			Setup of the CAN base ID (11 Bit or 29 Bit, hex format) for cyclic send of the three set values for U, I and P along with status in one single message. For more information refer to the programming guide. Default: 200h
		Cyclic Read Timing	Status			Activation/deactivation and time setting for the cyclic read of status to the adjusted „ Base ID Cyclic Read + 1 “ Range: 20...5000 ms. Default: 0 (deactivated)
			Actual val.			Activation/deactivation and time setting for the cyclic read of actual values to the adjusted „ Base ID Cyclic Read + 2 “ Range: 20...5000 ms. Default: 0 (deactivated)
			Set val.			Activation/deactivation and time setting for the cyclic read of set values of U & I to the adjusted „ Base ID Cyclic Read + 3 “ Range: 20...5000 ms. Default: 0 (deactivated)
			Limits 1			Activation/deactivation and time setting for the cyclic read of adjustment limits of P & R to the adjusted „ Base ID Cyclic Read + 4 “ Range: 20...5000 ms. Default: 0 (deactivated)
	Limits 2			Activation/deactivation and time setting for the cyclic read of adjustment limits of P & R to the adjusted „ Base ID Cyclic Read + 4 “		
	Data Length				Determines the DLC (data length) of all messages sent from the device. AUTO = length varies between 3 and 8 bytes, depending on object Always 8 Bytes = length is always 8, filled up with zeros	

IF	Level 1	Description
GPIB	Node Address	Adjustment of the GPIB node address (only with option 3W installed) in the range 1...30

Element	Description
Com Timeout	<p>Timeout USB/RS232 (in milliseconds) Default value: 5, Range: 5..65535 Defines the max. time between two subsequent bytes or blocks of a transferred message. For more information about the timeout refer to the external programming documentation "Programming ModBus & SCPI".</p> <p>Timeout ETH (in seconds) Default value: 5, Range: 5..65535 Defines a timeout after which the device would close the socket connection if there was no command communication between the controlling unit (PC, PLC etc.) and the device for the adjusted time. The timeout is ineffective as long as option "TCP keep-alive" is enabled and the keep-alive feature supported in the currently used network.</p>
Com Protocols	Enables or disables SCPI or ModBus RTU communication protocols for the device. The change is immediately effective after submitting it with ENTER button. Only one of both can be disabled.
Logging	Enables/disables the "log to USB stick" feature. Once enabled, you can define the log interval (multiple steps, 500 ms ... 5 s) and the control method. For more refer to „3.4.10. Recording to USB stick (logging)“.

3.4.3.8 Menu "HMI Setup"

These settings refer exclusively to the control panel (HMI).

Element	Description
Language	Selection of the display language between German, English, Russian and Chinese
Key Sound	Activates or deactivates sounds when touching a touch area in the display. It can usefully signal that the action has been accepted.
Alarm Sound	Activates or deactivates the additional acoustic signal of an alarm or user defined event which has been set to "Action = ALARM". See also „3.6 Alarms and monitoring“ on page 60.
HMI Lock	See „3.7 Control panel (HMI) lock“ on page 63.
Backlight	The choice here is whether the backlight remains permanently on or if it should be switched off when no input via screen or rotary knob is made for 60 s. As soon as input is made, the backlight returns automatically. Furthermore the backlight intensity can be adjusted here.
Status page	Enables/disables two display related options for the main screen with actual and set values: <p>Show meter bar: in U/I/P mode, i. e. resistance mode not activated, a meter bar for 0-100% actual values of voltage, current and power is shown. See „3.4.8. The meter bars“.</p> <p>Alternative status page: switches the main screen of the device with its actual and set values of voltage, current, power and - if activated - resistance to a simpler display with only voltage and current, plus status. See „3.4.7. Switching the main screen view“.</p> <p>Default setting: both disabled</p>
Limits Lock	See „3.8 Limits lock“ on page 63

3.4.4 Adjustment limits



Adjustment limits are only effective on the related set values, no matter if using manual adjustment or remote control!



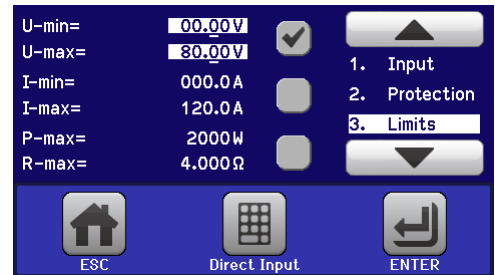

Defaults are, that all set values (U, I, P, R) are adjustable from 0 to 102% of the rated value.

This may be obstructive in some cases, especially for protection of applications against overcurrent. Therefore upper and lower limits for current (I) and voltage (U) can be set which limit the range of the adjustable set values.

For power (P) and resistance (R) only upper value limits can be set.



► How to configure the adjustment limits:

1. On the main screen, tap **SETTINGS** to access the SETTINGS menu.
2. Tap the arrows   to select "3. Limits".
3. In each case a pair of upper and lower limits for U/I or the upper limit for P/R are assigned to the rotary knobs and can be adjusted. Tap the selection area for another choice .
4. Accept the settings with .



The set values can be entered directly using the ten-key pad. This appears when the touch area for direct input is tapped (bottom center)



The adjustment limits are coupled to the set values. It means, that the upper limit may not be set lower than the corresponding set value. Example: If you wish to set the limit for the power set value (P-max) to 3000 W while the currently adjusted power set value is 3000 W, then the set value first would have to be reduced to 3000 W or less, in order to set P-max down to 3000 W.

3.4.5 Changing the operating mode

In general, the manual operation of an ELR 9000 HP distinguishes between three operating modes (U/I, P/I, R/I) which are tied to set value input using the rotary knobs or ten-key pad: This assignment must be changed if one of the four set values is to be adjusted which is currently not available.

► How to change the operating mode (two options)

1. Unless the device is in remote control or the panel is locked, you can switch the operation anytime. Tap on the depiction of the left-hand knob (see figure to the right) to change its assignment between U, P and R, or
2. You directly tap on the coloured areas with the set values, like shown in the figure to the right. The unit next to the set values, when inverted, indicates the assignment of the knobs. In the example to the right they have P and I assigned, which means P/I mode.

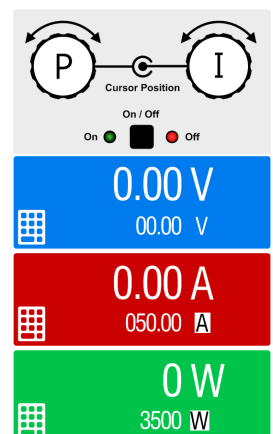

Depending on the selection the left rotary knob will be assigned different setting values, the right knob is always assigned to the current.



In order to avoid constant changing of the assignments it is possible, e.g. with selection R/I, to change the other values U and P by direct input. Also see section 3.4.6.

The actual operating mode of the load, which is only effective and indicated while the DC input is switched on, solely depends on the set values and the input voltage. For more information see section „3.2. Operating modes“.

3.4.6 Manual adjustment of set values

The set values for voltage, current, power and resistance are the fundamental operating possibilities of an electronic load and hence the two rotary knobs on the front of the device are always assigned to two of the four values in manual operation.

The set values can be entered manually in two ways: via rotary knob or direct input.



Entering a value changes it immediately and no matter if the DC input is switched on or off.



When adjusting the set values, upper or lower limits may come into effect. See section „3.4.4. Adjustment limits“. Once a limit is reached, the display will show a note like “Limit: U-max” etc. for 1.5 seconds next to the adjusted value.

► How to adjust values with the rotary knobs

1. First check if the value you want to change is already assigned to one of the rotary knobs. The main screen displays the assignment as depicted in the figure to the right.
2. If, as shown in the example, the assignment is voltage (U, left) and current (I, right), and it is required to set the power, then the assignments can be changed by tapping this touch area. A set of selection fields then appears.
3. After successful selection, the desired value can be set within the defined limits. Selecting a digit is done by pushing the rotary knob which shifts the cursor from right to left (selected digit will be underlined):

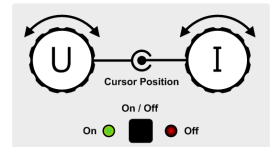

► How to adjust values via direct input

1. In the main screen, depending on the rotary knob assignment, values can be set for voltage (U), current (I), power (P) or resistance (R) via direct input by tapping on the small keypad symbol in the set/actual value display areas, e.g in the uppermost area of voltage.
2. Enter the required value using the ten-key pad. Similar to a pocket calculator the key **c** clears the input.

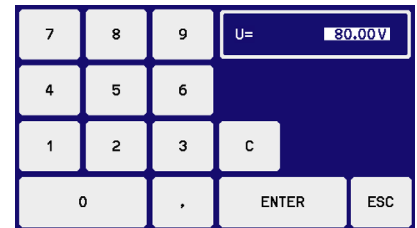

Decimal values are set by tapping the point key. For example, 54.3 V is set with **5** **4** **,** **3** and **ENTER**.

3. The display reverts to the main page and the set values take effect.

3.4.7 Switching the main screen view

The main screen, also called status page, with its set values, actual values and device status can be switched from the standard view mode with three or four values to a simpler mode with only voltage and current display. The advantage of the alternative view mode is that actual values are displayed with **much bigger characters**, so they read be read from a larger distance. Refer to „3.4.3.8. Menu “HMI Setup”“ to see where to switch the view mode in the MENU. Comparison:

Standard status page

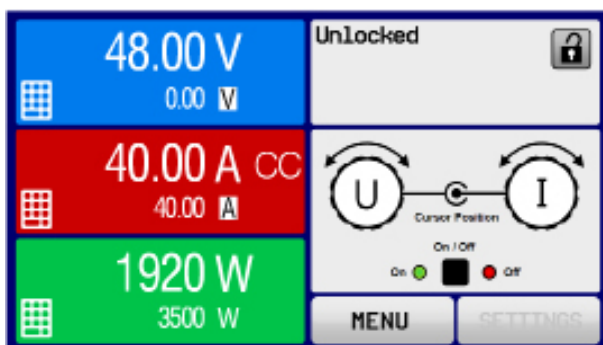

Alternative status page



Limitations of the alternative status page:

- Set and actual values of power are not displayed and the set value of power is only indirectly accessible
- The set value of resistance is not displayed and only indirectly accessible
- No access to the settings overview (MENU button) while the DC input is on



In alternative status page mode, the set values of power and resistance are not adjustable while the DC input is switched on. They can only be accessed and adjusted in SETTINGS while the DC input is off.

Rules for manual handling of the HMI in alternative status page mode:

- The two rotary knobs are assigned to voltage (left knob) and current (right knob) all the time, except for menus
- Set values input is the same as in standard status page mode, with knobs or by direct input
- Regulation modes CP and CR are displayed alternatively to CC at the same position

3.4.8 The meter bars

Additionally to the actual values being displayed as numbers, meter bars for U, I and P can be enabled in the MENU. The meter bars are not displayed as long as resistance mode, i. e. U/I/R is activated. Refer to „3.4.3.8. Menu “HMI Setup”“ to see where to enable the meter bars in the MENU. Depiction:

Standard status page with meter bar

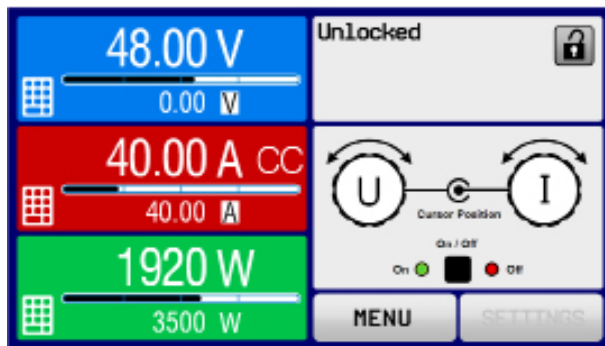

Alternative status page with meter bar

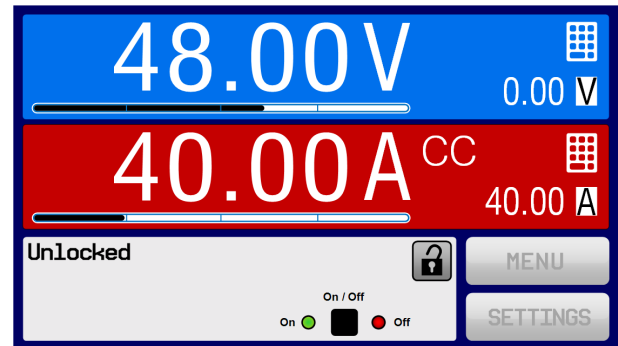

3.4.9 Switching the DC input on or off

The DC input of the device can be manually or remotely switched on and off. This can be restricted in manual operation by the control panel being locked.



Switching the DC input on during manual operation or digital remote control can be disabled by pin REM-SB of the built-in analog interface. For more information refer to 3.4.3.1 and example a) in 3.5.4.7. In such a situation, the device will show a notification in the display.

► How to manually switch the DC input on or off

1. As long as the control panel (HMI) is not fully locked press the button ON/OFF. Otherwise you are asked to disable the HMI lock first.
2. This button toggles between on and off, as long as a change is not restricted by an alarm or the device is locked in “Remote”. The condition is displayed by LED depictions.

► How to remotely switch the DC input on or off via the analog interface

1. See section „3.5.4 Remote control via the analog interface (AI)“ on page 56.

► How to remotely switch the DC input on or off via the digital interface

1. See the external documentation “Programming Guide ModBus & SCPI” if you are using custom software, or refer to the external documentation of LabView VIs or other documentation provided by Intepro Systems.

3.4.10 Recording to USB stick (logging)

Device data can be recorded to USB stick (2.0 / 3.0 may work, but not all vendors are supported) anytime. For specifications of the USB stick and the generated log files refer to section „1.9.6.5. USB port (front side)“.



The logging stores files of CSV format on the stick. The layout of the log data is the same as when logging via PC with software Power Control. The advantage of USB logging over PC logging is the mobility and that no PC is required. The logging feature just has to be activated and configured in the MENU.

3.4.10.1 Configuration

Also see section 3.4.3.7. After USB logging has been enabled and the parameters “Logging interval” and “Start/Stop” have been set, logging can be started anytime from within the MENU or after leaving it, depends on the selected start/stop mode.

3.4.10.2 Handling (start/stop)

With setting “**Start/stop with DC input ON/OFF**” logging will start each time the DC input of the device is switched on, no matter if manually with the front button “On/Off” or remotely via analog or digital interface. With setting “**Manual start/stop**” it is different. Logging is then started and stopped only in the MENU, in the logging configuration page.

Soon after logging has been started, the symbol  indicates the ongoing logging action. In case there is an error while logging, such as USB stick full or removed, it will be indicated by another symbol (). After every manual stop or switching the DC input off the logging is stopped and the log file closed.

3.4.10.3 Log file format

Type: text file in european CSV format

Layout:

	A	B	C	D	E	F	G	H	I	J	K	L	M
1	U set	U actual	I set	I actual	P set	P actual	R set	R actual	R mode	Output/Input	Device mode	Error	Time
2	2,00V	11,92V	1,20A	1,20A	7344W	15W	N/A	N/A	OFF	ON	CC	NONE	00:00:00,942
3	2,00V	11,90V	1,20A	1,20A	7344W	15W	N/A	N/A	OFF	ON	CC	NONE	00:00:01,942
4	2,00V	11,89V	1,20A	1,20A	7344W	15W	N/A	N/A	OFF	ON	CC	NONE	00:00:02,942
5	2,00V	11,87V	1,20A	1,20A	7344W	15W	N/A	N/A	OFF	ON	CC	NONE	00:00:03,942

Legend:

U set / I set / P set / R set: Set values

U actual / I actual / P actual / R actual: Actual values

Error: device alarms

Time: elapsed time since logging start

Device mode: actual regulation mode (also see „3.2. Operating modes“)

Important to know:

- R set and R actual are only recorded if UIR mode is active (refer to section 3.4.5)
- Unlike the logging on PC, every log start here creates a new log file with a counter in the file name, starting generally with 1, but minding existing files

3.4.10.4 Special notes and limitations

- Max. log file size (due to FAT32 formatting): 4 GB
- Max. number of log files in folder HMI_FILES: 1024
- With setting “**Start/stop with DC input ON/OFF**”, the logging will also stop on alarms or events with action “Alarm”, because they switch off the DC input
- With setting “**Manual start/stop**” the device will continue to log even on occurring alarms, so this mode can be used to determine the period of temporary alarms like OT or PF

3.5 Remote control

3.5.1 General

Remote control is possible via the built-in analog or USB port or via one of the optional interface modules (only with standard models of ELR series) or via the GPIB port (only with option 3W installed). Important here is that only the analog or one digital interface can be in control. It means that if, for example, an attempt were to be made to switch to remote control via the digital interface whilst analog remote control is active (Pin Remote = LOW) the device would report an error via the digital interface. In the opposite direction a switch-over via Pin Remote would be ignored. In both cases, however, status monitoring and reading of values are always possible.

3.5.2 Controls locations

Control locations are those locations from where the device can be controlled. Essentially there are two: at the device (manual control) and external (remote control). The following locations are defined:

Displayed location	Description
-	If neither of the other locations is displayed then manual control is active and access from the analog and digital interfaces is allowed. This location is not explicitly displayed
Remote	Remote control via any interface is active
Local	Remote control is locked, only manual operation is allowed.

Remote control may be allowed or inhibited using the setting “**Allow remote control**” (see “3.4.3.1. Menu “General Settings”). In inhibited condition, the status “**Local**” will be displayed top right. Activating the lock can be useful if the device is remotely controlled by software or some electronic device, but it is required to make adjustments at the device or deal with emergency, which would not be possible remotely.

Activating condition “**Local**” causes the following:

- If remote control via the digital interface is active (“**Remote**”), then it is immediately terminated and in order to continue remote control once “**Local**” is no longer active, it has to be reactivated at the PC
- If remote control via the analog interface is active (“**Remote**”), then it is temporarily interrupted until remote control is allowed again by deactivating “**Local**”, because pin “Remote” continues to signal “remote control = on”, unless this has been changed during the “**Local**” period

3.5.3 Remote control via a digital interface

3.5.3.1 Selecting an interface



Models with option 3W installed offer a GPIB port instead of the interface module slot, which makes it impossible to install and use any of these interface modules.

The standard models of series ELR 9000 HP support, in addition to the built-in USB port, the following optionally available interface modules:

Short ID	Type	Ports	Description*
IF-AB-CANO	CANopen	1	CANopen slave with generic EDS
IF-AB-RS232	RS232	1	Standard RS232, serial
IF-AB-PBUS	Profibus	1	Profibus DP-V1 slave
IF-AB-ETH1P	Ethernet	1	Ethernet TCP
IF-AB-PNET1P	ProfiNet	1	Profinet DP-V1 slave
IF-AB-MBUS	ModBus TCP	1	ModBus TCP protocol via Ethernet
IF-AB-ETH2P	Ethernet	2	ModBus RTU over Ethernet TCP, with switch
IF-AB-MBUS2P	ModBus TCP	2	ModBus TCP protocol via Ethernet
IF-AB-PNET2P	ProfiNet	2	Profinet DP-V1 slave, with switch
IF-AB-CAN	CAN	1	CAN 2.0 A & 2.0 B
IF-AB-ECT	EtherCAT	2	EtherCAT Slave

* For technical details of the various modules see the extra documentation “Programming Guide Modbus & SCPI”

3.5.3.2 General information about the interface modules

With the standard models of series ELR 9000 HP, one of the plug-in and retrofittable modules listed in 3.5.3.1 can be installed. It can take over remote control of the device alternatively to the built-in USB type B on the back side or the analog interface. For installation see section „2.3.9. *Installation of an interface module*“ and separate documentation.

The modules require little or no settings for operation and can be directly used with their default configuration. All specific settings will be permanently stored such that, after changeover between the various models, no re-configuration will be necessary.

3.5.3.3 Programming

Programming details for the interfaces, the communication protocols etc. are to be found in the documentation “Programming Guide ModBus & SCPI“ which is supplied on the included USB stick or which is available as download from the Intepro Systems website.

3.5.4 Remote control via the analog interface (AI)

3.5.4.1 General

The built-in, galvanically isolated, 15-pole analog interface (short: AI) is on the back side of the device offers the following possibilities:

- Remote control of current, voltage, power and resistance
- Remote status monitoring (CC/CP, CV, DC output)
- Remote alarm monitoring (OT, OVP, OCP, OPP, PF)
- Remote monitoring of actual values
- Remote on/off switching of the DC input

Setting the **three** set values for voltage, current and power via the analog interface must always be done **concurrently**. It means, that for example the voltage can not be given via the AI and current and power set by the rotary knobs, or vice versa. Resistance mode is additionally possible and requires to set the corresponding pin.

The OVP set value and other supervision (events) and alarm thresholds cannot be set via the AI and therefore must be adapted to the given situation before the AI is going to be in control. Analog set values can be supplied by an external voltage or generated from the reference voltage on pin 3. As soon as remote control via the analog interface is activated, the displayed set values will be those provided by the interface.

The AI can be operated in the common voltage ranges 0...5 V and 0...10 V, both representing 0...100% of the nominal value. The selection of the voltage range can be done in the device setup. See section „3.4.3. *Configuration via MENU*“ for details.

The reference voltage sent out from pin 3 (VREF) will be adapted accordingly:

0-5 V: Reference voltage = 5 V, 0...5 V set value signal for VSEL, CSEL, PSEL and RSEL correspond to 0...100% nominal value, 0...100% actual values correspond to 0...5 V at the actual value outputs CMON and VMON.

0-10 V: Reference voltage = 10 V, 0...10 V set value signal for VSEL, CSEL, PSEL and RSEL correspond to 0...100% nominal values, 0...100% actual values correspond to 0...10 V at the actual value outputs CMON and VMON.

Input of excess signals (e.g. >5 V in selected 5 V range or >10 V in the 10 V range) are clipped by the device by setting the corresponding set value to 100%.

Before you begin, please read these important notes about the use of the interface:



After powering the device and during the start phase the AI signals undefined statuses on the output pins such as ALARMS 1. Those must be ignored until is ready to work.

- Analog remote control of the device must be activated by switching pin “REMOTE” (5) first. Only exception is pin REM-SB, which can be used independently
- Before the hardware is connected that will control the analog interface, it shall be checked that it can't provide voltage to the pins higher than specified
- Set value inputs, such as VSEL, CSEL, PSEL and RSEL (if R mode is activated), must not be left unconnected (i.e. floating) during analog remote control. In case any of the set values is not used for adjustment, it can be tied to a defined level or connected to pin VREF (solder bridge or different), so it gives 100%

3.5.4.2 Resolution and sample rate

The analog interface is internally sampled and processed by a digital microcontroller. This causes a limited resolution of analog steps. The resolution is the same for set values (VSEL etc.) and actual values (VMON/CMON) and is 26214 when working with the 10 V range. In the 5 V range this resolution halves. Due to tolerances, the truly achievable resolution can be slightly lower.

There is furthermore a max. sample rate of 500 Hz. It means, the device can acquire analog set values and states on digital pins 500 times per second.

3.5.4.3 Acknowledging device alarms

Device alarms (see 3.6.2) are always indicated in the front display and some of them are also reported as signal on the analog interface socket (see table below).

In case of a device alarm occurring during remote control via analog interface, the DC input will be switched off the same way as in manual control. Certain alarms can be monitored via the corresponding pins of the interface, other alarms can't. Those could only be monitored and detected via the actual values of voltage and current being all zero contrary to the set values.

Some device alarms (OV, OCP and OPP) have to be acknowledged (see „3.6.2. Device alarm and event handling“). Acknowledgement during analog remote control is done with pin REM-SB switching the DC input off and on again, means a HIGH-LOW-HIGH edge (min. 50ms for LOW), when using the default level setting for this pin.

3.5.4.4 Analog interface specification

Pin	Name	Type*	Description	Default levels	Electrical properties
1	VSEL	AI	Set voltage value	0...10 V or. 0...5 V correspond to 0..100% of U_{Nom}	Accuracy 0-5 V range: < 0.4% ***** Accuracy 0-10 V range: < 0.2% ***** Input impedance R_i >40 k...100 k
2	CSEL	AI	Set current value	0...10 V or. 0...5 V correspond to 0..100% of I_{Nom}	
3	VREF	AO	Reference voltage	10 V or 5 V	Tolerance < 0.2% at $I_{max} = +5$ mA Short-circuit-proof against AGND
4	DGND	POT	Digital ground		For control and status signals.
5	REMOTE	DI	Switching internal / remote control	Remote = LOW, $U_{Low} < 1$ V Internal = HIGH, $U_{High} > 4$ V Internal = Open	Voltage range = 0...30 V $I_{Max} = -1$ mA bei 5 V $U_{LOW\ to\ HIGH\ typ.} = 3$ V Rec'd sender: Open collector against DGND
6	ALARMS 1	DO	Overheating or power fail alarm	Alarm OT= HIGH, $U_{High} > 4$ V No Alarm OT= LOW, $U_{Low} < 1$ V	Quasi open collector with pull-up against V_{cc} ** With 5 V on the pin max. flow +1 mA $I_{Max} = -10$ mA at $U_{CE} = 0,3$ V $U_{Max} = 30$ V Short-circuit-proof against DGND
7	RSEL	AI	Set internal resistance value	0...10 V or. 0...5 V correspond to $R_{Min} \dots R_{Max}$	Accuracy 0-5 V range: < 0.4% ***** Accuracy 0-10 V range: < 0.2% ***** Input impedance R_i >40 k...100 k
8	PSEL	AI	Set power value	0...10 V or. 0...5 V correspond to 0..100% of P_{Nom}	
9	VMON	AO	Actual voltage	0...10 V or. 0...5 V correspond to 0..100% of U_{Nom}	Accuracy 0-5 V range: < 0.4% ***** Accuracy 0-10 V range: < 0.2% ***** at $I_{Max} = +2$ mA Short-circuit-proof against AGND
10	CMON	AO	Actual current	0...10 V or. 0...5 V correspond to 0..100% of I_{Nom}	
11	AGND	POT	Analog ground		For -SEL, -MON, VREF Signals
12	R-ACTIVE	DI	R mode on / off	On = LOW, $U_{Low} < 1$ V Off = HIGH, $U_{High} > 4$ V Off = Open	Voltage range = 0...30 V $I_{Max} = -1$ mA bei 5 V $U_{LOW\ to\ HIGH\ typ.} = 3$ V Rec'd sender: Open collector against DGND
13	REM-SB	DI	DC input OFF (DC input ON) (ACK alarms ****)	Off = LOW, $U_{Low} < 1$ V On= HIGH, $U_{High} > 4$ V On = Open	Voltage range = 0...30 V $I_{Max} = +1$ mA at 5 V Rec'd sender: Open collector against DGND
14	ALARMS 2	DO	Overvoltage alarm Overcurrent alarm Overpower alarm	Alarm = HIGH, $U_{High} > 4$ V No alarm = LOW, $U_{Low} < 1$ V	Quasi open collector with pull-up against V_{cc} ** With 5 V on the pin max. flow +1 mA $I_{Max} = -10$ mA at $U_{CE} = 0,3$ V, $U_{Max} = 30$ V Short-circuit-proof against DGND
15	STATUS***	DO	Constant voltage regulation active DC input	CV = LOW, $U_{Low} < 1$ V CC/CP/CR = HIGH, $U_{High} > 4$ V On = LOW, $U_{Low} < 1$ V Off = HIGH, $U_{High} > 4$ V	

* AI = Analog Input, AO = Analog Output, DI = Digital Input, DO = Digital Output, POT = Potential ** Internal Vcc approx. 10 V

*** Only one of both signals possible, see section 3.4.3.1 **** Only during remote control

***** The error of an analog input adds to the general error of the related value on the DC input of the device

3.5.4.5 Overview of the Sub-D Socket

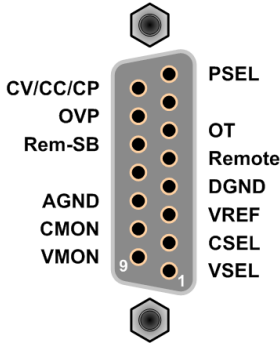

3.5.4.6 Simplified diagram of the pins

	<p>Digital Input (DI)</p> <p>It requires to use a switch with low resistance (relay, switch, circuit breaker etc.) in order to send a clean signal to the DGND.</p>		<p>Analog Input (AI)</p> <p>High resistance input (impedance >40 k....100 kΩ) for an OA circuit.</p>
	<p>Digital Output (DO)</p> <p>A quasi open collector, realised as high resistance pull-up against the internal supply. In condition LOW it can carry no load, merely switch, as shown in the diagram with a relay as example.</p>		<p>Analog Output (AO)</p> <p>Output from an OA circuit, with low impedance. See specifications table above.</p>

3.5.4.7 Application examples

a) Switching off the DC input via the pin “REM-SB”

 *A digital output, e.g. from a PLC, may be unable to cleanly effect this as it may not be of low enough resistance. Check the specification of the controlling application. Also see pin diagrams above.*

In remote control, pin REM-SB is used to switch the DC terminal of the device on and off. This function is also available without remote control being active and can on the one hand block the DC terminal from being switched on in manual or digital remote control and on the other hand the pin can switch the DC on or off, but not standalone. See below at “Remote control has not been activated”.

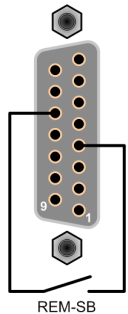

It is recommended that a low resistance contact such as a switch, relay or transistor is used to switch the pin to ground (DGND).

Following situations can occur:

- **Remote control has been activated**

During remote control via analog interface, only pin “REM-SB” determines the states of the DC input, according to the levels definitions in 3.5.4.4. The logical function and the default levels can be inverted by a parameter in the setup menu of the device. See 3.4.3.1.

 *If the pin is unconnected or the connected contact is open, the pin will be HIGH. With parameter “Analog interface REM-SB” being set to “normal”, it requests “DC input on”. So when activating remote control, the DC input would instantly switch on.*

• **Remote control is not active**

In this mode of operation pin "REM-SB" can serve as lock, preventing the DC input from being switched on by any means. This results in following possible situations:

DC-input	+	Pin „REM-SB“	+	Parameter „REM-SB“	→	Behaviour
is off	+	HIGH	+	normal	→	DC input not locked. It can be switched on by pushbutton "On/Off" (front panel) or via command from digital interface.
		LOW	+	inverted		
	+	HIGH	+	inverted	→	DC input locked. It can not be switched on by pushbutton "On/Off" (front panel) or via command from digital interface. When trying to switch on, a popup in the display resp. an error message will be generated.
		LOW	+	normal		

In case the DC input is already switched on, toggling the pin will switch the DC input off, similar to what it does in analog remote control:

DC-input	+	Pin „REM-SB“	+	Parameter „REM-SB“	→	Behaviour
is on	+	HIGH	+	normal	→	DC input remains on, nothing is locked. It can be switched on or off by pushbutton or digital command.
		LOW	+	inverted		
	+	HIGH	+	inverted	→	DC input will be switched off and locked. Later it can be switched on again by toggling the pin. During lock, pushbutton or digital command can delete the request to switch on by pin.
		LOW	+	normal		

b) Remote control of current and power.

Requires remote control to be activated (Pin "Remote" = LOW)

The set values PSEL and CSEL are generated from, for example, the reference voltage VREF, using potentiometers for each. Hence the electronic load can selectively work in current limiting or power limiting mode. According to the specification of max. 5 mA for the VREF output, potentiometers of at least 10 kΩ must be used.

The voltage set value VSEL is directly connected to AGND (ground) and therefore has no influence on constant current or power operation.

If the control voltage is fed in from an external source it is necessary to consider the input voltage ranges for set values (0...5 V or 0...10 V).

Use of the input voltage range 0...5 V for 0...100% set value halves the effective resolution.

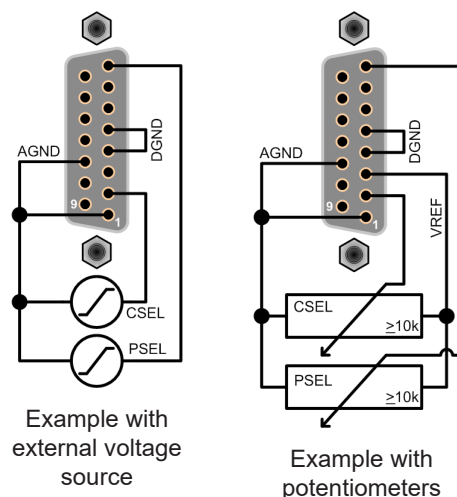

c) Reading actual values

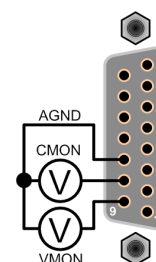

The AI provides the DC input values as current and voltage monitor. These can be read using a standard multimeter or similar.



3.6 Alarms and monitoring

3.6.1 Definition of terms

There is a clear distinction between device alarms (see „3.3. Alarm conditions“), such as overvoltage protection, and user defined events such as **OCD** (overcurrent detection). Whilst device alarms primarily serve to protect the connected DC source by switching the DC input off, user defined events can do the same (action = ALARM), but can also simply give an acoustic signal to make the user aware. The actions driven by user defined events can be selected:

Action	Impact	Example
NONE	User defined event is disabled.	
SIGNAL	On reaching the condition which triggers the event, the action SIGNAL will show a text message in the status area of the display.	
WARNING	On reaching the condition which triggers the event, the action WARNING will show a text message in the status area of the display and pop up an additional warning message.	
ALARM	On reaching the condition which triggers the event, the action ALARM will show a text message in the status area of the display with an additional alarm pop-up, and additionally emit an acoustic signal (if activated). Furthermore the DC input is switched off. Certain device alarms are also signalled to the analog interface or can be queried via the digital interface.	

3.6.2 Device alarm and event handling

Important to know:



- The current drained from a switching power supply or similar sources can be much higher than expected due to capacities on the source’s output, even if the source is current limited, and might thus trigger the overcurrent shutdown OCP or the overcurrent event OCD of the electronic load, in case these supervision thresholds are adjusted to too sensitive levels
- When switching off the DC input of the electronic load while a current limited source still supplies energy, the output voltage of the source will rise immediately and due to response and settling times in effect, the output voltage can have an overshoot of unknown level which might trigger the overvoltage shutdown OVP or overvoltage supervision event OVD, in case these thresholds are adjusted to too sensitive levels

A device alarm incident will usually lead to DC input switch-off, the appearance of a pop-up in the middle of the display and, if activated, an acoustic signal to make the user aware. The alarm must always be acknowledged. If the alarm condition no longer exists, e.g. the device has cooled down following overheating, the alarm indication will disappear. If the condition persists, the display remains and, following elimination of the cause, must be acknowledged again.

► How to acknowledge an alarm in the display (during manual control)

1. If the alarm is indicated as a pop-up, tap **OK**.
2. If the alarm has already been acknowledged, but is still displayed in the status area, then first tap the status area to make the alert pop up again and then acknowledge with **OK**.



In order to acknowledge an alarm during analog remote control, see „3.5.4.3. Acknowledging device alarms“. To acknowledge in digital remote, refer to the external documentation “Programming ModBus & SCPI”.

Some device alarms are configurable:

Alarm	Meaning	Description	Range	Indication
OVP	OverVoltage Protection	Triggers an alarm if the DC input voltage reaches the defined threshold. The DC input will be switched off.	0 V...1.1*U _{Nom}	Display, analog IF, digital IF
OCP	OverCurrent Protection	Triggers an alarm if the DC input current reaches the defined threshold. The DC input will be switched off.	0 A...1.1*I _{Nom}	Display, digital IF
OPP	OverPower Protection	Triggers an alarm if the DC input power reaches the defined threshold, The DC input will be switched off.	0 W...1.1*P _{Nom}	Display, digital IF

These device alarms can't be configured and are based on hardware:

Alarm	Meaning	Description	Indication
PF	Power Fail	Signalises various problems with the AC part. Triggers an alarm if the AC supply is out of specification or when the device is cut from supply, for example when switching it off with the power switch. The DC input will be switched off.	Display, digital IF
OT	OverTemperature	Triggers an alarm if the internal temperature exceeds a certain limit. The DC input will be switched off.	Display, analog IF, digital IF
MSP	Master-Slave Protection	Triggers an alarm if the master of an initialised master-slave system loses contact to any slave unit or if a slave has not yet been initialised by the master. The DC input will be switched off. The alarm can be cleared by either deactivating master-slave mode or reinitialising the MS system.	Display, digital IF

► How to configure the device alarms

1. While the DC input is switched off tap the touch area **SETTINGS** on the main screen.
2. On the right side tap the arrows to select "**2. Protect**".
3. Set the limits for the device alarm relevant to your application if the default value of 110% is unsuitable.



The set values can be entered using the ten-key tab. This will appear by tapping the touch area for direct input (ten key pad symbol).

The user also has the possibility of selecting whether an additional acoustic signal will be sounded if an alarm or user defined event occurs.

► How to configure the alarm sound (also see „3.4.3. Configuration via MENU“)

1. While the DC input is switched off tap the touch area **MENU** on the main screen.
2. In the menu page, tap "**HMI Settings**".
3. In the following menu page, tap "**Alarm Sound**".
4. In the settings page tap the button to select between "**Sound on**" or "**Sound off**" and confirm with



3.6.2.1 User defined events

The monitoring functions of the device can be configured for user defined events. By default, events are deactivated (action = NONE). Contrary to device alarms, the events only work while the DC input is switched on. It means, for instance, that you cannot detect undervoltage (UVD) anymore after switching the DC input off and the voltage is still sinking.



The following events can be configured independently and can, in each case, trigger the actions NONE, SIGNAL, WARNING or ALARM.

Event	Meaning	Description	Range
UVD	UnderVoltage Detection	Triggers an event if the input voltage falls below the defined threshold.	0 V...U _{Nom}
OVD	OverVoltage Detection	Triggers an event if the input voltage exceeds the defined threshold.	0 V...U _{Nom}
UCD	UnderCurrent Detection	Triggers an event if the input current falls below the defined threshold.	0 A...I _{Nom}
OCD	OverCurrent Detection	Triggers an event if the input current exceeds the defined threshold.	0 A...I _{Nom}
OPD	OverPower Detection	Triggers an event if the input power exceeds the defined threshold.	0 W...P _{Nom}



These events should not be confused with alarms such as OT and OVP which are for device protection. User defined events can, however, if set to action ALARM, switch off the DC input and thus protect the source (power supply, battery)

► How to configure user defined events

1. While the DC input is switched off tap the touch area  on the main screen.
2. On the right side tap the arrows   to select "4.1 Event U" or "4.2 Event I" or "4.3 Event P".
3. Set the monitoring limits with the left hand rotary knob and the triggered action with the right hand knob relevant to the application (also see „3.6.1. Definition of terms“).

4. Accept the settings with .



User events are an integral part of the actual user profile. Thus, if another user profile, or the default profile, is selected and used, the events will be either differently or not configured.





The set values can be entered using the ten-key tab. This will appear by tapping the touch area for direct input (ten key pad symbol) on the particular page.

3.7 Control panel (HMI) lock

In order to avoid the accidental alteration of a value during manual operation, the rotary knobs or the touchscreen can be locked so that no alteration of values will be accepted without prior unlocking.

► How to lock the HMI

1. In the main page, tap the lock symbol  (upper right corner).
2. In the settings page “**HMI Lock**” you are then asked to chose between a complete HMI (“**Lock all**”) lock or one where the On/Off button is still usable (“**ON/OFF possible**”), resp. chose to activate the additional PIN (“**Enable PIN**”). The device would later request to enter this PIN every time you want to unlock the HMI, until the PIN is deactivated again.
3. Activate the lock with . The status “**Locked**” as shown in the figure to the right.

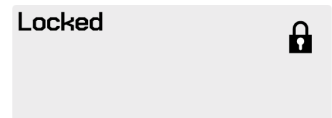

If an attempt is made to alter something whilst the HMI is locked, a requester appears in the display asking if the lock should be disabled.

► How to unlock the HMI

1. Tap any part of the touchscreen of the locked HMI, or turn one of the rotary knobs or press the button “On/Off” (only in “Lock all” situation).
2. This request pop-up will appear: .
3. Unlock the HMI by tapping on “Tap to unlock” within 5 seconds, otherwise the pop-up will disappear and the HMI remains locked. In case the additional **PIN code lock** has been activated in the menu “**HMI Lock**”, another requester will pop up, asking you to enter the **PIN** before it finally unlocks the HMI.

3.8 Limits lock

In order to avoid the alteration of the adjustment limits (also see „3.4.4. *Adjustment limits*“) by an unprivileged user, the screen with the adjustment limit settings (“Limits”) can be locked by a PIN code. The menu pages “**3.Limits**” in SETTINGS and “**Profiles**” in MENU will then become inaccessible until the lock is removed by entering the correct PIN or in case it has been forgotten, by resetting the device as last resort.

► How to lock the “Limits”

1. While the DC input is switched off, tap the touch area  on the main screen.
2. In the menu tap “**Limits Lock**”.
3. In the next page set the check mark for “**Lock**”.



The same PIN as with the HMI lock is used here. It should be set before activating the Limits lock. See „3.7. Control panel (HMI) lock“

4. Activate the lock by leaving the settings page with .



Be careful to enable the lock if you are unsure what PIN is currently set. In doubt use ESC to exit the menu page. In menu page “HMI Lock” you can define a different PIN, but not without entering the old one.

► How to unlock the limits settings

1. While the DC input is switched off, tap the touch area  on the main screen.
2. In the menu tap “**Limits Lock**”.
3. In the next page tap on touch area “**Unlock**” and then you will be asked to enter the 4-digit PIN.
4. Deactivate the lock by entering the correct PIN and submitting with ENTER.



3.9 Loading and saving a user profile

The menu “**Profiles**” serves to select between a default profile and up to 5 user profiles. A profile is a collection of all settings and set values. Upon delivery, or after a reset, all 6 profiles have the same settings and all set values are 0. If the user changes settings or sets target values then these create a working profile which can be saved to one of the 5 user profiles. These profiles or the default one can then be switched. The default profile is read-only. Loading the default profile is equivalent to a reset.

The purpose of a profile is to load a set of set values, settings limits and monitoring thresholds quickly without having to readjust these. As all HMI settings are saved in the profile, including language, a profile change can also be accompanied by a change in HMI language.

On calling up the menu page and selecting a profile the most important settings can be seen, but not changed.

► How to save the current values and settings as a user profile

1. Tap the touch area  on the main screen
2. In the menu page, tap .
3. In the selection screen (right) choose between user profile 1-5 in which the settings are to be saved. The profile will then be displayed and the values can be checked, but not changed.
4. Save using the touch area .

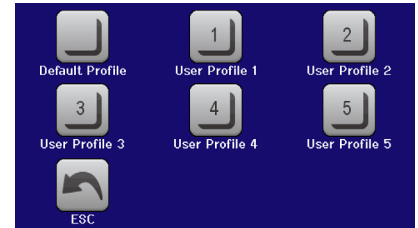

3.10 The function generator

3.10.1 Introduction

The built-in function generator is able to create various signal forms and apply these to the set value of voltage or current.

The standard functions are based on an **arbitrary generator** and directly accessible and configurable using manual control. For remote control, the fully customisable arbitrary generator replicates the functions with sequences containing 8 parameters each. Further functions, such as UI-IU, are based on a table with 4096 values, working as **XY function**. **Battery test** and **MPP tracking** are software based functions only.

The following functions are retrievable, configurable and controllable:

Function	Short description
Sine wave	Sine wave generation with adjustable amplitude, offset and frequency
Triangle	Triangular wave signal generation with adjustable amplitude, offset, rise and fall times
Rectangular	Rectangular wave signal generation with adjustable amplitude, offset and duty cycle
Trapezoid	Trapezoidal wave signal generation with adjustable amplitude, offset, rise time, pulse time, fall time, idle time
DIN 40839	Simulated automobile engine start curve according to DIN 40839 / EN ISO 7637, split into 5 curve sequences, each with a start voltage, final voltage and time
Arbitrary	Generation of a process with up to 99 freely configurable curve points, each with a start and end value (AC/DC), start and end frequency, phase angle and total duration
Ramp	Generation of a linear rise or fall ramp with start and end values and time before and after the ramp
UI-IU	Table (.csv) with values for U or I, uploaded from an USB flash drive
Battery test	Battery discharge test with constant or pulsed current, along with Ah, Wh and time counters
MPP Tracking	Simulation of the characteristic tracking behaviour of solar inverters when seeking to find the maximum power point (MPP) when being connected to typical sources such as solar panels

3.10.2 General

3.10.2.1 Limitations

The function generator is not accessible, neither for manual access, nor for remote control, if resistance mode (R/I adjustment mode, also called UIR mode) is active.

3.10.2.2 Resolution

Amplitudes generated by the arbitrary generator have an effective resolution of approx. 52428 steps. If the amplitude is very low and the time long, the device would generate less steps and set multiple identical values after another, generating a staircase effect. It is furthermore not possible to generate every possible combination of time and a varying amplitude (slope).

The XY generator, which works in table mode, has an effective resolution of 3276 steps for the set value range of 0-100% rated value.

3.10.2.3 Minimum slope / maximum ramp time

When using a rising or falling offset (i.e. DC part) at functions like ramp, trapezoid, triangle and even sine wave, a minimum slope, calculated from the rated values of voltage or current, is required or else the adjusted settings would be neglected by the device. Calculating the minimum slope can help to determine if a certain ramp over time can be achieved by the device or not. Example: model ELR 9080-170 HP is going to be used, with 80 V and 170 A rating. **Formula: minimum slope = 0.000725 * rated value / s.** For the example model it results in $\Delta U/\Delta t$ of 58 mV/s and $\Delta I/\Delta t$ of 13 mA/s. The maximum time which can be achieved with the minimum slope then calculates as approximately 1379 seconds according to formula $t_{\text{Max}} = \text{rated value} / \text{min. slope}$.

3.10.3 Method of operation

In order to understand how the function generator works and how the value settings interact, the following should be noted:

The device operates always with the three set values U, I and P, also in function generator mode.

The selected function can be used on one of the values U or I, the other two are then constants and have a limiting effect. That means, if, e.g. a voltage of 30 V is applied to the DC input and a sine wave function should operate on the current with an amplitude of 200 A and offset 200 A, then the function generator will create a sine wave progression of current between 0 A (min) and 400 A (max), which will result in an input power between 0 W (min) and 12000 W (max). The input power, however, is limited to its set value. If this were 9000 W then, in this case, the current would be limited to 300 A and if clamped to an oscilloscope it would be seen to be capped at 300 A and never achieve the target of 400 A.

Another case is when working with a function which is applied to the input voltage. If here the static voltage is set higher than the amplitude plus offset then at function start there will be no reaction, as the voltage regulation limits down to 0 with an electronic load, other than current or power. The correct settings for each of the other set values is therefore essential.

3.10.4 Manual operation

3.10.4.1 Function selection and control

Via the touchscreen one of the functions described in 3.10.1 can be called up, configured and controlled. Selection and configuration are only possible when the input is switched off.





► How to select a function and adjust parameters

1. While the DC input is switched off, Tap the touch area  on the main screen.

2. In the menu overview tap on the touch area  and then on the desired function or  to access the next page.

 Touch area "Function generator" is locked in R mode (adjustable resistance).

3. Depending on the choice of function there follows a request to which input value the function generator is going to be applied ( / ) or, when accessing the battery test function, to select the battery test mode.
4. Adjust the parameters as you desire, like offset, amplitude and frequency for a sine wave, for example.

 For the AC part of a function and if the difference between start and end value of amplitude or frequency is too low (min. $\Delta Y/\Delta t$), depending on the time that is defined for one function run, the function generator will not accept the settings and pop up an error.

5. Also adjust the overall limits of voltage, current and power, which you can access with touch area .

 When entering function generator mode, those global limits are reset to safe values, which might prevent the function from working at all. For example, if you apply the selected function to the input current, then the overall current limit should not interfere and should at least be as high as offset + amplitude.

Setting the various functions is described below. After setting it up, the function can be loaded.

► How to load a function

1. After setting the values for the required signal generation, tap on the



touch area

The device will then load the data into the internal controller and changes the display. Shortly afterwards the static values are set (power and voltage or current), the DC input is switched on and the touch area **START** enabled. Only then can the function be started.

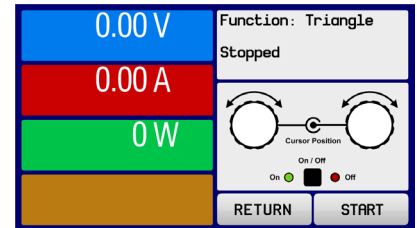

Because the DC input is automatically switched on in order to settle the start situation, the static values are effective to the source immediately after loading the function. These static values represent the situation before start and after the end of the function, so it doesn't need to start from 0. Only exception: when applying any function to the current (I), there is no adjustable static current value, so the function would always start from 0 A.

► How to start and stop a function

1. The function can be **started** either by tapping **START** or pushing the "On/Off" button, if the DC input is currently switched off. The function then starts immediately. In case START is used while the DC input is still switched off, it will be switched on automatically.
2. The function can be **stopped** either by tapping **STOP** or pushing the "On/Off" button. However, there is a difference:
 - a) Touch area **STOP** only stops the function, the DC input remains ON with the static value in effect.
 - b) The "On/Off" button stops the function and switches the DC input off.



Every device alarm (overvoltage, overtemperature etc.) or protection (OPP, OCP) or event with action = Alarm stops the function progress automatically, switches off the DC input and reports the alarm in the display.

3.10.5 Sine wave function

The following parameters can be configured for a sine function:

Value	Range	Description
I(A), U(A)	0...(Nominal value - (Offs)) of U, I	A = Amplitude of the signal to be generated
I(Offs), U(Offs)	(A)...(Nominal value - (A)) of U, I	Offs = Offset, based on the zero point of the mathematical sine curve, may not be smaller than the amplitude.
f (1/t)	1...10000 Hz	Static frequency of the signal to be generated

Schematic diagram:

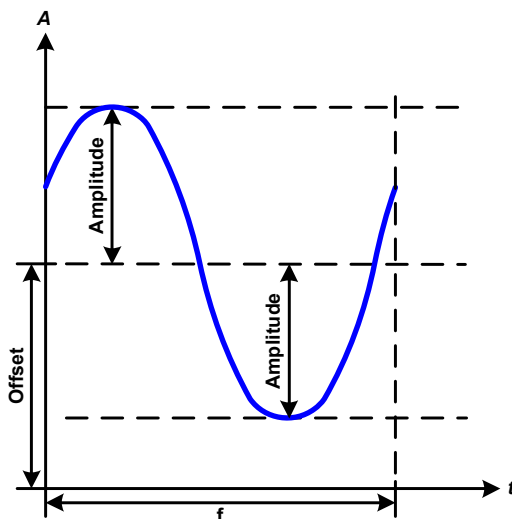

Application and result:

A normal sine wave signal is generated and applied to the selected set value, e.g. current (I). At a constant input voltage the current input of the load will follow a sine wave.

For calculating the maximum power input the amplitude and offset values for the current must be added.

Example: with an input voltage of 100 V and sin(I) selected, set the amplitude to 30 A and the offset to 50 A. The resulting maximum input power is then achieved at the highest point of the sine wave and is $(30 \text{ A} + 50 \text{ A}) \cdot 100 \text{ V} = 8000 \text{ W}$.

3.10.6 Triangular function

The following parameters can be configured for a triangular wave function:

Value	Range	Description
I(A), U(A)	0...(Nominal value - (Offs)) of U, I	A = Amplitude of the signal to be generated
I(Offs), U(Offs)	0...(Nominal value - (A)) of U, I	Offs = Offset, based on the foot of the triangular wave
t1	0.1 ms...36000 s	Time for the positive slope of the triangular wave signal.
t2	0.1 ms...36000 s	Time for the negative slope of the triangular wave signal

Schematic diagram:

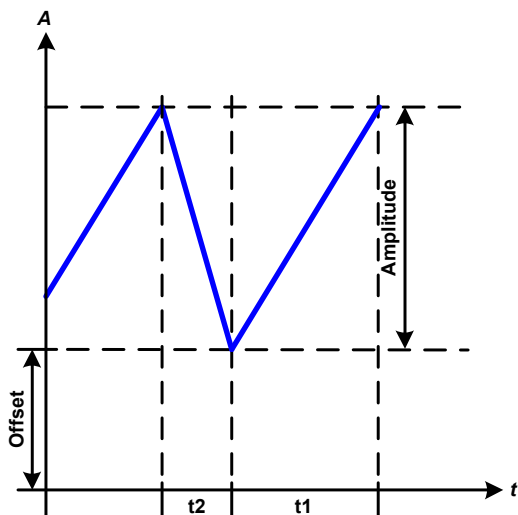

Application and result:

A triangular wave signal for input current (direct) or input voltage (indirect) is generated. The positive and negative slope times are variable and can be set independently.

The offset shifts the signal on the Y-axis.

The sum of the intervals t1 and t2 gives the cycle time and its reciprocal is the frequency.

Example: a frequency of 10 Hz is required and would lead to periodic duration of 100 ms. This 100 ms can be freely allocated to t1 and t2, e.g. 50 ms:50 ms (isosceles triangle) or 99.9 ms:0.1 ms (right-angled triangle or sawtooth).

3.10.7 Rectangular function

The following parameters can be configured for a rectangular wave function:

Value	Range	Description
I(A), U(A)	0...(Nominal value - (Offs)) of U, I	A = Amplitude of the signal to be generated
I(Offs), U(Offs)	0...(Nominal value - (A)) of U, I	Offs = Offset, based on the foot of the rectangular wave
t1	0.1 ms...36000 s	Time (pulse width) of the upper level (amplitude)
t2	0.1 ms...36000 s	Time (pause width) of the lower level (offset)

Schematic diagram:

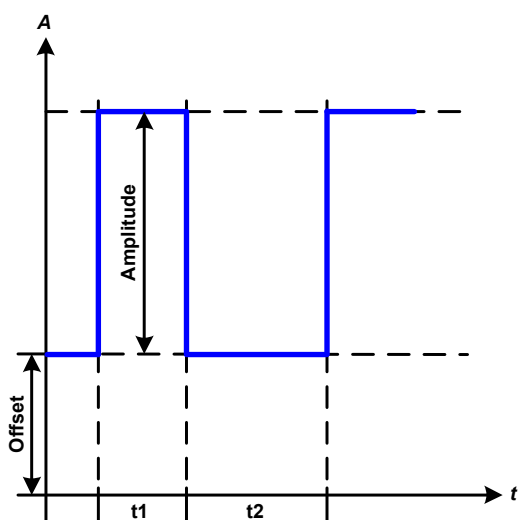

Application and result:

A rectangular or square wave signal for input current (direct) or input voltage (indirect) is generated. The intervals t1 and t2 define how long the value of the amplitude (pulse) and how long the value of the offset (pause) are effective.

The offset shifts the signal on the Y axis.

Intervals t1 and t2 can be used to define a duty cycle. The sum of t1 and t2 gives the period and its reciprocal is the frequency.

Example: a rectangular wave signal of 25 Hz and a duty cycle of 80% are required. The sum of t1 and t2, the period, is 1/25 Hz = 40 ms. For a duty cycle of 80% the pulse time (t1) is 40 ms*0.8 = 32 ms and the pause time (t2) is 8 ms

3.10.8 Trapezoidal function

The following parameters can be configured for a trapezoidal curve function:

Value	Range	Description
I(A), U(A)	0...(Nominal value - (Offs)) of U, I	A = Amplitude of the signal to be generated
I(Offs), U(Offs)	0...(Nominal value - (A)) of U, I	Offs = Offset, based on the foot of the trapezium
t1	0.1 ms...36000 s	Time for the negative slope of the trapezoidal wave signal
t2	0.1 ms...36000 s	Time for the top value of the trapezoidal wave signal
t3	0.1 ms...36000 s	Time for the negative slope of the trapezoidal wave signal
t4	0.1 ms...36000 s	Time for the base value (offset) of the trapezoidal wave signal

Schematic diagram:

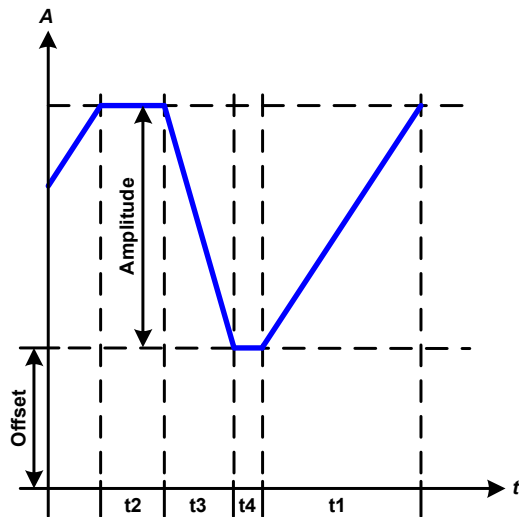

Application and result:

Here a trapezoidal signal can be applied to a set value of U or I. The slopes of the trapezium can be varied by setting different times for rise and fall.

The periodic duration and repeat frequency are the result of four time elements. With suitable settings the trapezium can be deformed to a triangular or rectangular wave. It has, therefore, universal use.

3.10.9 DIN 40839 function

This function is based on the curve defined in DIN 40839 / EN ISO 7637 (test impulse 4), and is only applicable to voltage. It shall replicate the progress of automobile battery voltage during engine starting. The curve is divided into 5 sequences (see diagram below) which each have the same parameters. The standard values from the DIN are set already as default values for the five sequences.

The following parameters can be configured for the DIN40839 function:

Value	Range	Seq	Description
Ustart	0...Nominal value of U	1-5	Start voltage of the ramp
Uend	0...Nominal value of U	1-5	End voltage of the ramp
Seq.time	0.1 ms...36000 s	1-5	Time of the ramp
Seq.cycles	∞ or 1...999	-	Number of repetitions of the entire curve
Time t1	0.1 ms...36000 s	-	Time after cycle before repetition (cycle > 1)

Schematic diagram:

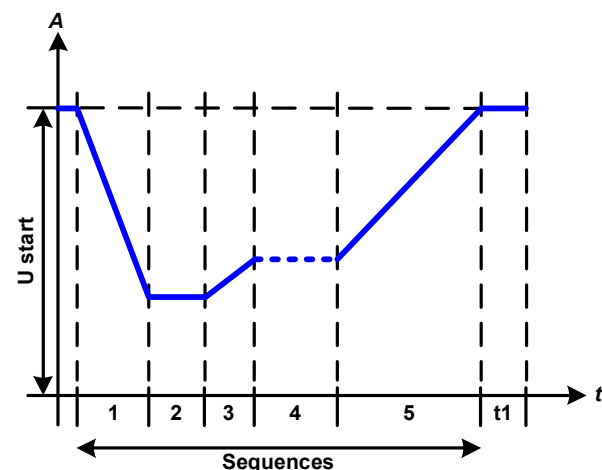

Application and result:

The function's primary use is to load a source, i. e. power supply, which cannot generate the curve itself and would supply a static DC voltage. The load acts as a sink for the rapid fall of the output voltage of the power supply enabling the voltage progress to follow the DIN curve. The only requirement for the source is that it features (an adjustable) current limitation.

The curve conforms to test impulse 4 of the DIN. With suitable settings, other test impulses can be simulated. If the curve in sequence point 4 should be a sine wave, then these 5 sequences would have to be reconstructed using the arbitrary generator.

3.10.10 Arbitrary function

The arbitrary (freely definable) function offers the user further scope. There are 99 sequence points available for use on current I or voltage U, all of which have the same parameters but which can be differently configured so that a complex function process can be built up. The 99 sequence points can run one after another in a sequence point block, and this block can then be repeated up to 999 times or endlessly. From the 99 sequence points a block can be freely defined to run from point x to point y. A sequence point or sequence point block acts only on current or voltage, thus a mix of assignment to current I or voltage U is not possible.

The arbitrary curve overlays a linear progression (DC) with a sine curve (AC), whose amplitude and frequency are shaped between start and end values. If both, start frequency (f_s) and end frequency (f_e) are 0 Hz, the AC values have no impact and only the DC part is effective. Each sequence point is allocated a time in which the AC/DC curve from start to finish will be generated.

The following parameters can be configured for each sequence point in the arbitrary function (the table lists parameters for current, for voltage it would be U_s , U_e etc.)

Value	Range	Description
$I_s(AC)$	0...50% Nominal value of I	Start amplitude of the sine wave part of the curve (AC)
$I_e(AC)$	0...50% Nominal value of I	End amplitude of the sine wave part of the curve (AC)
$f_s(1/T)$	0 Hz...10000 Hz	Start frequency of the sine wave part of the curve (AC)
$f_e(1/T)$	0 Hz...10000 Hz	End frequency of the sine wave part of the curve (AC)
Angle	0 °...359 °	Start angle of the sine wave part of the curve (AC)
$I_s(DC)$	$I_s(AC)$...(Nominal value - $I_s(AC)$) of I	Start value of the DC part of the curve
$I_e(DC)$	$I_e(AC)$...(Nominal value - $I_e(AC)$) of I	End value of the DC part of the curve
Seq.time	0.1 ms...36000 s	Sequence point time



The sequence point time (seq. time) and the start and end frequency are related. The minimum value for $\Delta f/s$ is 9.3. Thus, for example, a setting of $f_s = 1$ Hz, $f_e = 11$ Hz and Seq.time = 5 s would not be accepted as $\Delta f/s$ is only 2. A seq. time of 1 s would be accepted, or, if the time remains at 5 s, then $f_e = 51$ Hz must be set.



Also the amplitude change between start and end is related to the sequence point time. A minimal change over an extended time is not possible and in such a case the device will report an inapplicable setting.

After the settings for the selected sequence points are accepted with SAVE, further sequence points can be configured. If the button NEXT is touched a second settings screen appears in which global settings for all 99 points are displayed.

The following parameters can be set for the total run of an arbitrary function:

Value	Range	Description
Start seq.	1...End seq.	First sequence point in the block
End seq.	Start seq...99	Last sequence point in the block
Seq. Cycles	∞ or 1...999	Number of cycles to run the block.

Schematic diagram:

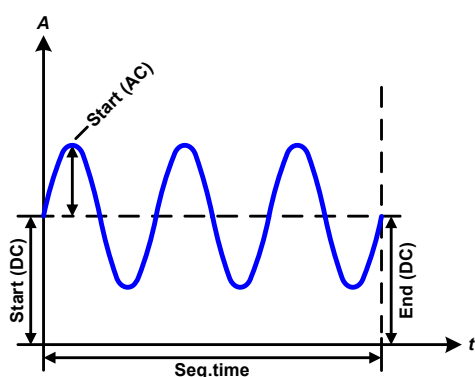

Applications and results:

Example 1

Focussing 1 cycle of 1 sequence point from 99

DC values for start and end are the same, also the AC amplitude. With a frequency >0 a sine wave progression of the set value is generated with a defined amplitude, frequency and Y shift (offset, DC value at start and end)

The number of sine waves per cycle depend on the sequence point time and the frequency. If the time was 1 s and the frequency 1 Hz, there would be exactly 1 sine wave. If the time was 0.5 s at the same frequency, there would only be a half sine wave.

Schematic diagram:

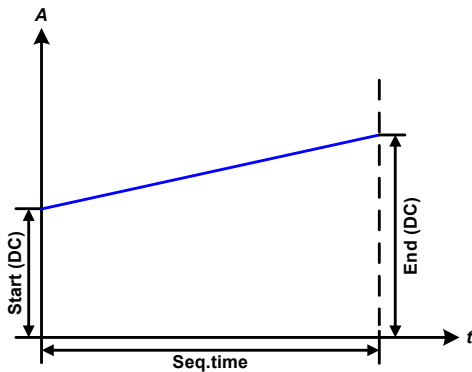
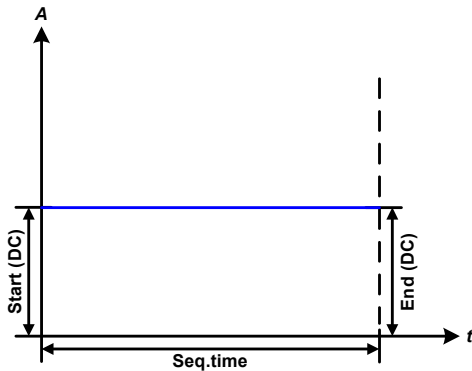
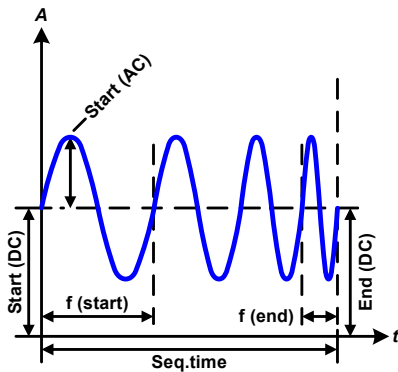
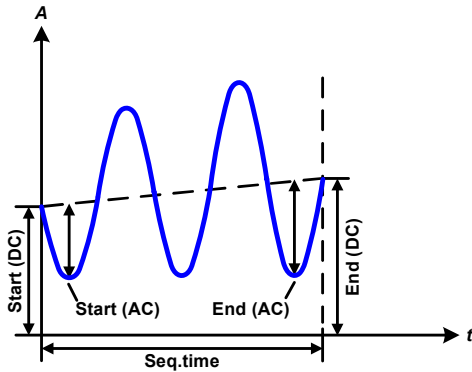
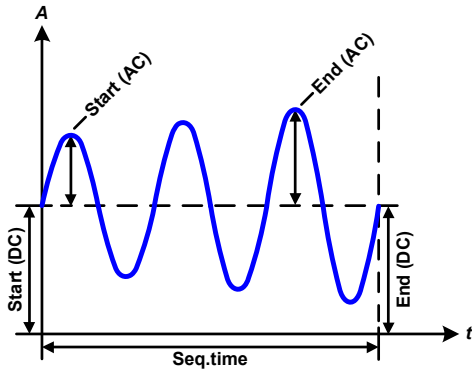

Applications and results:

Example 2

Focussing 1 cycle of 1 sequence point from 99:

The DC values at start and end are the same but the AC (amplitude) not. The end value is higher than the start so that the amplitude increases with each new half sine wave continuously through the sequence. This, of course, only if the sequence point time and frequency allow for multiple waves to be created. e.g. for $f=1$ Hz and $\text{Seq. time} = 3$ s, three complete waves would be generated (for angle = 0°) and reciprocally the same for $f=3$ s and $\text{Seq. time}=1$ s.

Example 3

Focussing 1 cycle of 1 sequence point from 99:

The DC values at start and end are unequal, as are also the AC values. In both cases the end value is higher than the start so that the offset increases from start to end (DC) and the amplitude also with each new half sine wave.

Additionally the first sine wave starts with a negative half wave because the angle is set at 180° . The start angle can be shifted at will in 1° steps between 0° and 359° .

Example 4

Focussing 1 cycle of 1 sequence point from 99:

Similar to example 1 but with another end frequency. Here this is shown as higher than the start frequency. This impacts the period of the sine waves such that each new wave will be shorter over the total span of the sequence point time.

Example 5

Focussing 1 cycle of 1 sequence point from 99:

Similar to example 1 but with a start and end frequency of 0 Hz. Without a frequency no sine wave part (AC) will be created and only the DC settings will be effective. A ramp with a horizontal progression is generated.

Example 6

Focussing 1 cycle of 1 sequence point from 99:

Similar to example 1 but with a start and end frequency of 0 Hz. Without a frequency no sine wave part (AC) will be created and only the DC settings will be effective. Here start and end values are unequal and a steadily increasing ramp is generated.

By linking together a number of differently configured sequence points, complex progressions can be created. Smart configuration of the arbitrary generator can be used to match triangular, sine, rectangular or trapezoidal wave functions and thus, e.g. a curve of rectangular waves with differing amplitudes or duty cycles could be produced.

Schematic diagrams:

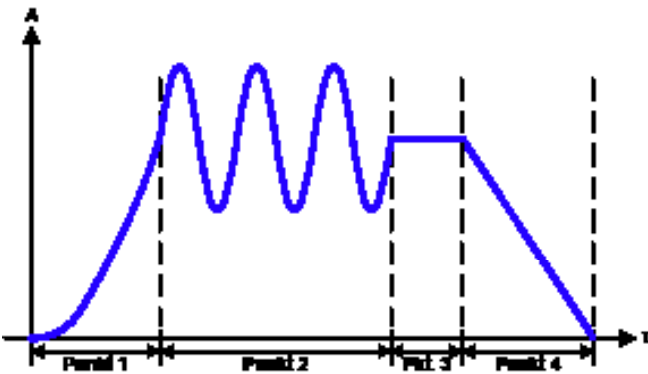
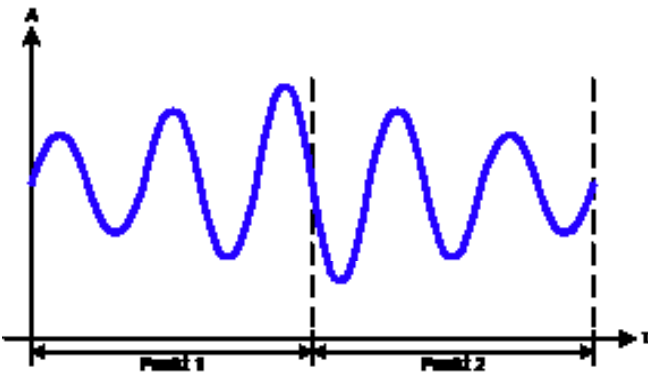
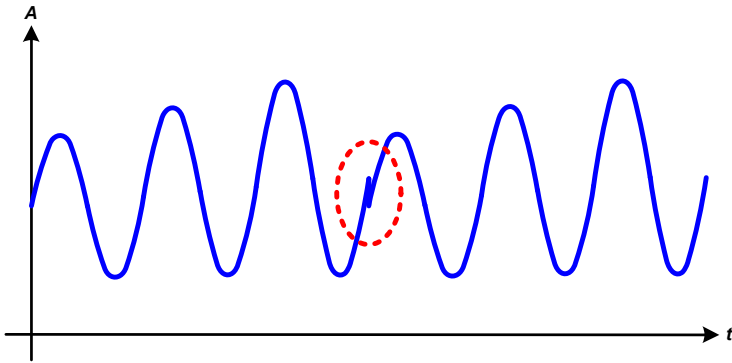

Applications and results:

Example 7

Focussing 2 cycles of 1 sequence point from 99:

A sequence point configured as in example 3 is run. As the settings demand that the end offset (DC) is higher than the start, the second sequence run will revert to the same start level as the first, regardless of the values achieved at the end of the first run. This can produce a discontinuity in the total progression (marked in red) which may only be compensated with careful choice of settings.

Example 8

Focussing 1 cycle of 2 sequence points from 99:

Two sequence points run consecutively. The first generates a sine wave with increasing amplitude, the second with a decreasing amplitude. Together they produce a progression as shown left. In order to ensure that the maximum wave in the middle occurs only once, the first sequence point must end with a positive half wave and the second start with a negative half wave (angle=180°) as shown in the diagram.

Example 9

Focussing 1 cycle of 4 sequence points from 99:

Point 1: 1/4th of sine wave (angle = 270 °)

Point 2: 3 Sine waves (ratio of frequency to sequence time: 1:3)

Point 3: Horizontal ramp (f = 0)

Point 4: Falling ramp (f = 0)

3.10.10.1 Loading and saving the arbitrary function

The 99 sequences of the arbitrary function, which can be manually configured with the control panel of the device and which are applicable either to voltage (U) or current (I), can be saved to or loaded from a common USB flash drive via the front side USB port. Generally, all 99 sequences are saved or loaded using a text file of type CSV (semicolon separator), which represents a table of values.

In order to load a sequence table for the arbitrary generator, following requirements have to be met:

- The table must contain exactly 99 rows with 8 subsequent values (8 columns) and must not have gaps
- The column separator (semicolon, comma) must be as selected by parameter "USB file separator format"; it also defines the decimal separator (dot, comma)
- The files must be stored inside a folder called HMI_FILES which has to be in the root of the USB drive
- The file name must always start with WAVE_U or WAVE_I (not case-sensitive)
- All values in every row and column have to be within the specified range (see below)
- The columns in the table have to be in a defined order which must not be changed

Following value ranges are given for use in the table, related to the manual configuration of the arbitrary generator (column headers like in Excel):

Column	Parameter	Range
A	AC start amplitude	0...50% U or I
B	AC end amplitude	0...50% U or I
C	Start frequency	0...10000 Hz
D	End frequency	0...10000 Hz
E	AC start angle	0...359°
F	DC start offset	0...(Nominal value of U or I) - AC start amplitude
G	DC end offset	0...(Nominal value of U or I) - AC end amplitude
H	Sequence point time in µs	100...36.000.000.000 (36 billion µs)

For details about the parameter and the arbitrary function refer to „3.10.10. Arbitrary function“.

Example CSV:



	A	B	C	D	E	F	G	H	
1	20,00	30,00		5	5	90	50,00	50,00	50000000
2	30,00	20,00		5	5	90	50,00	50,00	30000000
3	0,00	0,00		0	0	0	0,00	0,00	1000
4	0,00	0,00		0	0	0	0,00	0,00	1000
5	0,00	0,00		0	0	0	0,00	0,00	1000
6	0,00	0,00		0	0	0	0,00	0,00	1000

The example shows that only the first two sequencen points are configured, while all others are set to default values. The table could be loaded as WAVE_U or WAVE_I when using, for example, the model ELR 9080-170 HP, because the values would fit both, voltage and current. The file naming, however, is unique. A filter prevents you from loading a WAVE_I file after you have selected "Arbitrary --> U" in the function generator menu. The file would not be listed at all.

► How to load a sequence point table from an USB flash drive:

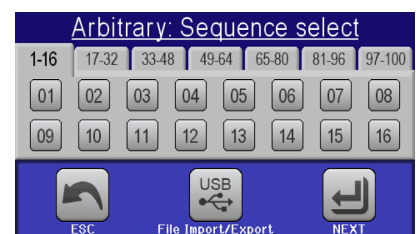
1. Do not plug the USB drive yet or remove it.
2. Access the function selection menu of the function generator with MENU -> Function Generator -> Arbitrary -> U/I, to see the main screen of sequence point selector, as depicted to the right.



3. Tap touch area  then  and follow the instructions on screen. If at least one valid files has been recognized (for file and path naming see above), the device will show a list of files to select from with .

4. Tap touch area  in the bottom right corner. The selected file is then checked and loaded, if valid. In case it is not valid, the device will show an error message. Then the file must be corrected and the steps repeated.

► How to save a sequence point table to an USB flash drive:

1. Do not plug the USB flash drive yet or remove it.
2. Access the function selection menu of the function generator via MENU -> Function Generator -> Arbitrary



3. Tap on **File Import/Export**, then **SAVE to USB**. The device will request you to plug the USB flash drive now.
4. After plugging it, the device will try to access the flash drive and find the folder HMI_FILES and read the content. If there are already WAVE_U or WAVE_I files present, they will be listed and you can either select one for overwriting with , otherwise select **-NEW FILE-** for a new file.



5. Finally save the sequence table with **SAVE to USB**.

3.10.11 Ramp function

The following parameters can be configured for a ramp function:

Value	Range	Description
Ustart / Istart	0...Nominal value of U, I	Start value (U,I)
Uend / Iend	0...Nominal value of U, I	End value (U, I)
t1	0.1 ms...36000 s	Time before ramp-up or ramp-down of the signal.
t2	0.1 ms...36000 s	Ramp-up or ramp-down time

Schematic diagram:

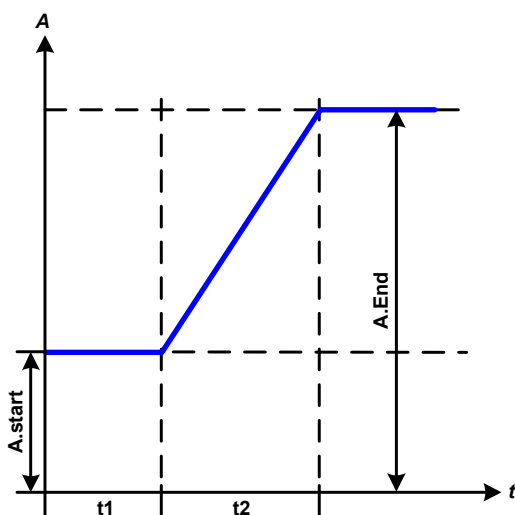

Application and result:

This function generates a rising or falling ramp between start and end values over the time t2. Time t1 creates a delay before the ramp starts.

The function runs once and stops at the end value. To have a repeating ramp, function Trapezoid would have to be used instead (see 3.10.8).

Important to consider are the static values of U and I which define the start levels at the beginning of the ramp. It is recommended that these values are set equal to those in A.start, unless the power source shall not be loaded before the start of the ramp. In that case the static values should be set to zero.



10h after reaching the ramp end, the function will stop automatically (i.e. I = 0 A resp. U = 0 V), unless it has been stopped manually before.

3.10.12 UI and IU table functions (XY table)

The UI and IU functions offer the user the possibility to set a DC input current dependant on the DC input voltage, or a DC input voltage dependant on the DC input current. The function is table driven with exactly 4096 values, which are distributed over the whole measured range of actual input voltage or input current in the range of 0...125% Unom or Inom. The table can either be uploaded from an USB flash drive through the front side USB port of the device or via remote control (ModBus RTU protocol or SCPI). The functions are:

UI function: $U = f(I)$

IU function: $I = f(U)$

In the **UI function**, the device measuring circuit determines the level from 0 to maximum of the input current. For each of the 4096 possible values for input current a voltage value is maintained by the user in the UI table which can be any value between 0 and nominal value. The values uploaded from an USB flash drive will always be interpreted as voltage values even if the user calculated them as current values and incorrectly loaded them as an UI table.

In the **IU function** the assignment of the values is the other way round, the behaviour, however, the same.

Thus the behaviour of the load or the current and power consumption can be controlled with dependance on input voltage and step changes can be created.



Uploading of a table from an USB flash drive must use text files in CSV format (.csv). Plausibility is checked on loading (values not too high, number of values correct), and possible errors reported in which case the table will not be loaded.



The values in the table are checked for correct values and count. If all the values were to be graphically plotted a curve would be created which could include significant step changes in current or voltage. That could lead to complications in the loading of the source if, e. g., the internal voltage measurement in the electronic load swings slightly so that the load jumps backwards and forwards between two values in the table, which, in the worst case, could be 0 A and the maximum current.

3.10.12.1 Loading UI and IU tables from USB drive

The so-called UI / IU function generator requires to load tables from a common FAT32 formatted USB drive via the front side USB port. The files are required to have a certain format and to meet following specifications:

- The files names must always begin with IU or UI (not case-sensitive), depending on the target function you want to load the table to
- The file must be a text file of type Excel CSV and must only contain one column with exactly 4096 values without gaps
- Values with decimal places must use a decimal separator as depending on the selection with parameter "USB file separator format" ("US": separator = comma, decimal separator = dot)
- None of values may exceed the related maximum value of the device. For example if you have a 80 V model you are going to load the table for the UI function, it is assumed that all the values in the table are for voltage and thus must not be bigger than 80 (the adjustment limits of the device are not in effect here)
- The files must be stored inside a folder called HMI_FILES with has to be in the root of the USB drive



If the file naming, path and file content specifications are not met, the file is either not recognized at all or rejected. So it is, for example, impossible to load an UI table (file name starts with UI) for the IU function and vice versa. The USB drive may contain multiple files of which up to 10 are listed as a selection before loading.

► How to load an UI or IU table from USB flash drive:

1. Do not plug the USB drive yet or pull it out if already plugged.
2. Open the function selection menu of the function manager with MENU -> Function Generator -> XY Table
3. In the next screen select the desired function with either „UI Table“ or „IU Table“.
4. Configure the global parameters for U, I and P, if necessary.



5. Tap touch area **LOAD from USB** and plug the USB drive when requested, in order to select one out of X compatible files from the drive. In case the file is not accepted, the device will report an error in the display and also tell what's wrong with the file.
6. Once the file is accepted, you will be requested to remove the USB drive.



7. Submit and load the function with **LOAD** to start and control it as with other function (also see „3.10.4.1. Function selection and control“).

3.10.13 Battery test function

The purpose of the battery test function is to discharge various battery types in industrial product tests or laboratory applications. It is only available via access on the HMI, at least as setup and use are described below, but can also be achieved in remote control using the arbitrary function generator. The only disadvantage in remote control are the missing counters of battery capacity (Ah), energy (Wh) and time. But those can be calculated by custom remote control software when programming a time counter and regularly querying actual values from the device.

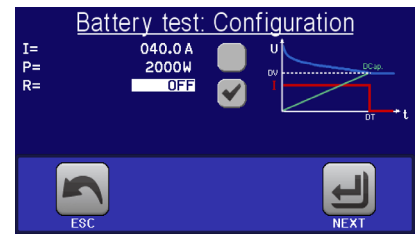

The function is usually applied on the DC input current and can either be selected and run in “Static” (constant current) or “Dynamic” (pulsed current) mode. In static mode, the settings for power or resistance can also let the device run the function in constant power (CP) or constant resistance (CR). Like in the normal operation of the load the set values determine what regulation mode (CC, CP, CR) is resulting on the DC input. If, for example, CP operation is projected, the set values of current should be set to maximum and resistance mode should be turned off, so that both don’t interfere. For a projected CR operation it is similar. There current and power should be set to maximum.

For dynamic mode there is also a power setting, but it cannot be used to run the dynamic battery test function in pulsed power mode or at least the result would not be as expected. It is recommended to adjust the power values always according to the test parameters, so it doesn’t interfere with the pulsed current, i. e. dynamic mode.

When discharging with high currents, compared to the nominal battery capacity and in dynamic mode, it may happen that the battery voltage shortly drops below the U-DV threshold and the test will unintentionally stop. Here it is recommended to adjust U-DV accordingly.

Graphical depiction of both battery test modes:

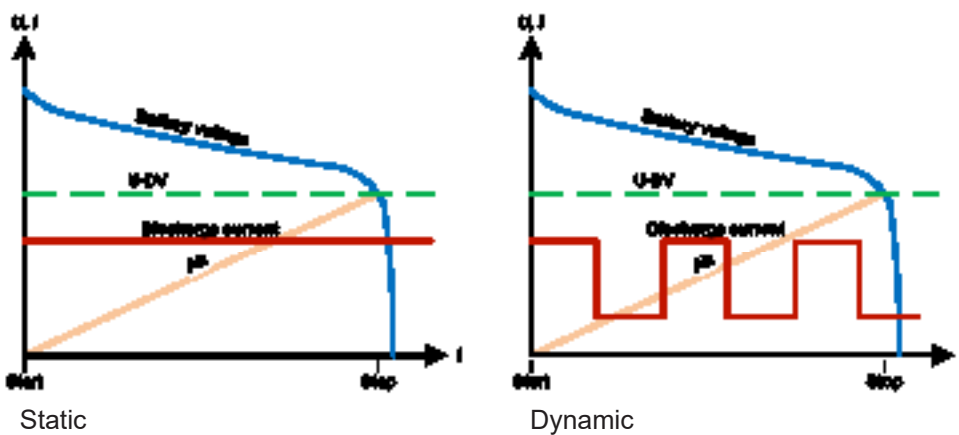

3.10.13.1 Parameters for static mode

The following parameters can be configured for the static battery test function.

Value	Range	Description
I	0...Nominal value of I	Maximum discharge current in Ampere
P	0...Nominal value of P	Maximum discharge power in Watt
R	Min....max. nominal value of R	Maximum discharge resistance in Ω (can be deactivated --> “OFF”)

3.10.13.2 Parameters for dynamic mode

The following parameters can be configured for the dynamic battery test function.

Value	Range	Description
I ₁	0...Nominal value of I	Upper resp. lower current setting for pulsed operation (the higher value of both is automatically used as upper level)
I ₂	0...Nominal value of I	
P	0...Nominal value of P	Maximum discharge power in Watt
t ₁	1 s ... 36000 s	t1 = Time for the upper level of the pulsed current (pulse)
t ₂	1 s ... 36000 s	t2 = Time for the lower level of the pulsed current (pause)

3.10.13.3 Other parameters

These parameters are available in both battery test modes, but the values are separately adjustable in each.

Parameter	Range	Description
Discharge voltage	0...Nominal value of U	Variable voltage threshold to make the test stop when reached (is connected to the battery voltage on the DC input of the load)
Discharge time	0...10 h	Maximum test time after which the test can stop automatically
Discharge capacity	0...99999 Ah	Maximum capacity to consume from the battery after which the test can stop automatically
Action	NONE, SIGNAL, End of test	Separately defines an action for parameters „Discharge time“ and „Discharge capacity“. It determines what shall happen with the test run once the adjusted values for those parameters are reached: NONE = No action, test will continue SIGNAL = Text "Time limit" will be displayed, test will continue End of test = The test will stop
Enable USB logging	on/off	By setting the check mark, USB logging is enabled and will record data on a properly formatted USB stick, if plugged in to the front USB port. The recorded data differs from the USB log data recorded during "normal" USB logging in all other operation modes of the device.
Logging interval	100 ms - 1 s, 5 s, 10 s	Writing interval for USB logging

3.10.13.4 Displayed values

During the test run, the display will show a set of values and status:

- Actual battery voltage on the DC input in V
- Actual discharge current in A
- Actual power in W
- Discharge voltage U_{DV} in V
- Consumed battery capacity in Ah
- Consumed energy in Wh
- Elapsed time in HH:MM:SS,MS
- Regulation mode (CC, CP, CR)

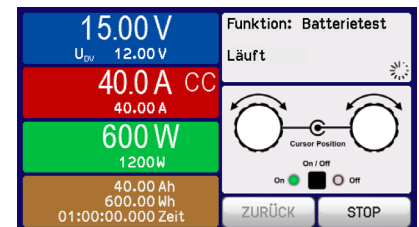

3.10.13.5 Data recording (USB logging)

At the end of the configuration of both, static and dynamic mode, there is the option to enable the USB logging feature. With an USB stick plugged and formatted as required (see), the device can record data during the test run directly to the stick and in the defined interval. Active USB logging is indicated in the display with a small disk symbol. After the test has stopped, the recorded data will be available as text file in CSV format.

Log file format:

	A	B	C	D	E	F	G
1	Static:Uset	Iset	Pset	Rset	DV	DT	DC
2	0,00V	0,00A	1200W	OFF	0,00V	10:00:00	99999,00Ah
3							
4	Uactual	Iactual	Pactual	Ah	Wh	Time	
5	0,34V	0,00A	0W	0,00Ah	0,00Wh	00:00:00,800	
6	0,28V	0,00A	0W	0,00Ah	0,00Wh	00:00:01,800	
7	0,28V	0,00A	0W	0,00Ah	0,00Wh	00:00:02,800	
8	0,28V	0,00A	0W	0,00Ah	0,00Wh	00:00:03,800	

Static = Selected mode
 Iset = Max. current
 Pset = Max. power
 Rset = Desired resistance
 DV = Discharge voltage
 DT = Discharge time
 DC = Discharge capacity
 U/I/Pactual = Actual values
 Ah = Consumed battery capacity
 Wh = Consumed energy



Regardless the setting for the recording interval, the values "Ah" and "Wh" are only calculated by the device once per second. When using an interval setting of < 1 s, several identical values of Ah and Wh are written into the CSV.

3.10.13.6 Possible reasons for battery test stop

The battery test function run can be stopped by different reasons:

- Manual stop on the HMI with button STOP
- After the max. test time has been reached and action “End of test” was set for it
- After the max. battery capacity to consume has been reached and action “End of test” was set for it
- Any device alarm which would also switch off the DC input, like OT
- Passing the threshold U_{DV} (discharge voltage), caused by whatever reason



After an automatic stop, caused by any of the listed reasons, the test cannot be continued or run again immediately. The full battery configuration has to be run through, accessible via touch area BACK.

3.10.14 MPP tracking function

MPP stands for the maximum power point (see principle view to the right) on the power curve of solar panels. Solar inverters, when connected to such panels, constantly track this MPP once it has been found.

The electronic load simulates this behaviour by a function. It can be used to test even huge solar panels without having to connect a usually big solar inverter device which also requires to have a load connected to its AC output. Furthermore, all MPP tracking related parameters of the load can be adjusted and it so is much more flexible than an inverter with its limited DC input range.

For evaluation and analysis purposes, the load can also record measured data, i. e. DC input values such as actual voltage, current or power, to USB stick or provide them for reading via digital interface.

The MPP tracking function offers four modes. Unlike with other functions or general use of the device, values for the MPP tracking are only entered by direct input via the touch screen.

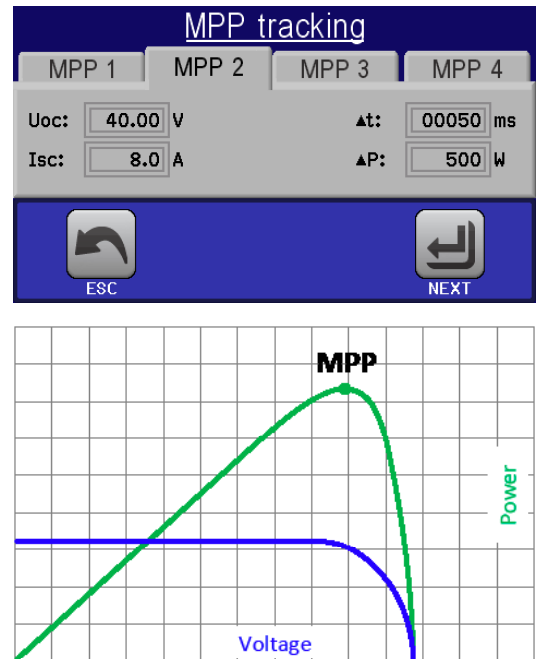

3.10.14.1 Mode MPP1

This mode is also called “find MPP”. It is the simplest option to have the electronic load find the MPP of a connected solar panel. It requires to set only three parameters. Value U_{OC} is necessary, because it helps to find the MPP quicker as if the load would start at 0 V or maximum voltage. Actually, it would start at a voltage level slightly above U_{OC} .

I_{SC} is used as an upper limit for the current, so the load would not try to draw more current than the panel is specified for.

Following parameters can be configured for tracking mode **MPP1**:

Value	Range	Description
U_{OC}	0...Nominal value of U	Voltage of the solar panel when unloaded, taken from the panel specs
I_{SC}	0...Nominal value of I	Short-circuit current, max. specified current of the solar panel
Δt	5 ms...65535 ms	Interval for measuring U and I during the process of finding the MPP

Application and result:

After the three parameters have been set, the function can be started. As soon as the MPP has been found, the function will stop and switch off the DC input. The acquired MPP values of voltage (U_{MPP}), current (I_{MPP}) and power (P_{MPP}) are then shown in the display.

The time of a function run depends on the parameter Δt . Even with the minimum setting of 5 ms one run take already a few seconds.

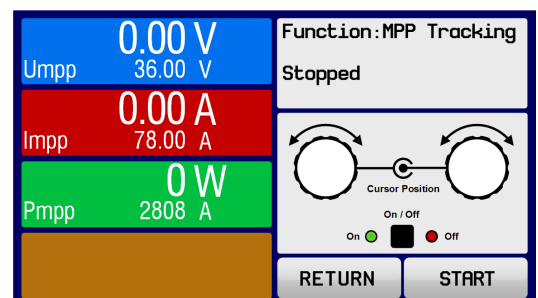

3.10.14.2 Mode MPP2

This mode tracks the MPP, so it is closest to the operation of a solar inverter. Once the MPP is found, the function won't stop, but try to track the MPP permanently. Due to the nature of solar panels this can only be done below the level of the MPP. As soon as this point is reached, the voltage starts to sink further and so does the actual power. The additional parameter ΔP defines how much the power may sink before the direction is reversed and the voltage starts to rise again until the load reaches the MPP. The result are zigzag shaped curves of both, voltage and current.

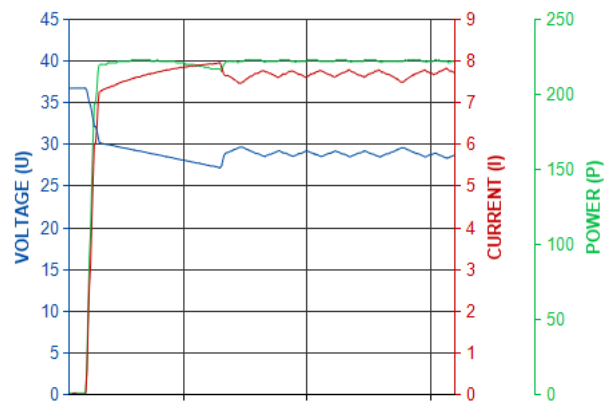

A typical curve display is shown in the picture to the right. For the example, the ΔP was set to a quite small value, so the power curve looks almost linear. With a small ΔP the load would always track close to the MPP.

Following parameters can be configured for tracking mode **MPP2**:

Value	Range	Description
U_{OC}	0...Nominal value of U	Voltage of the solar panel when unloaded, taken from the panel specs
I_{SC}	0...Nominal value of I	Short-circuit current, max. specified current of the solar panel
Δt	5 ms...65535 ms	Interval for measuring U and I during the process of finding the MPP
ΔP	0 W...0.5 P_{Nom}	Tracking/regulation tolerance below the MPP

3.10.14.3 Mode MPP3

Also called "fast track", this mode is very similar to mode MPP2, but without the initial step which is used to find the actual MPP, because mode MPP3 would directly jump to the power point defined by user input (U_{MPP} , P_{MPP}). In case the MPP values of the equipment under test are known, this can save a lot of time in repetitive tests. The rest of the function run is the same as with MPP2 mode. During and after the function, the least acquired MPP values of voltage (U_{MPP}), current (I_{MPP}) and power (P_{MPP}) are shown in the display.

Following parameters can be configured for tracking mode **MPP3**:

Value	Range	Description
U_{MPP}	0...Nominal value of U	Voltage in the MPP
I_{SC}	0...Nominal value of I	Short-circuit current, max. specified current of the solar panel
P_{MPP}	0...Nominal value of P	Power in the MPP
Δt	5 ms...65535 ms	Interval for measuring U and I during the process of finding the MPP
ΔP	0 W...0.5 P_{Nom}	Tracking/regulation tolerance below the MPP

3.10.14.4 Mode MPP4

This mode is different, because it does not track automatically. It rather offers the choice to define a user curve by setting up to 100 points of voltage values, then track this curve, measure current and power and return the results in up to 100 sets of acquired data. The curve points can be entered manually or loaded from USB stick. Start and end point can be adjusted arbitrarily, Δt defines the time between two points and the function run can be repeated up to 65535 times. Once the function stops at the end or by manual interrupt, the DC input is switched off and the measured data is made available. After the function, the acquired set of data with the highest actual power will be shown in the display as voltage (U_{MPP}), current (I_{MPP}) and power (P_{MPP}) of the MPP. Going back on the screen with RETURN then allows for data export to USB stick.

Following parameters can be configured for tracking mode **MPP4**:

Value	Range	Description
$U_1...U_{100}$	0...Nominal value of U	Voltage for the up to 100 user definable curve points
Start	1-100	Start point for the run of x out of 100 subsequent points
End	1-100	End point for the run of x out of 100 subsequent points
Δt	5 ms...65535 ms	Time before the next point
Rep.	0-65535	Number of repetitions for the run from Start to End

3.10.14.5 Load or save MPP4 data

The 100 voltage values on the user-defined curve used to run in mode MPP4 can either be loaded from USB stick or via digital interface. Using the way to load via HMI requires following file format (for correct naming see 1.9.6.4):

- Type CSV (text file)
- 1 column with 100 values, which are allowed to be within 0 and the rated voltage of the device model
- The decimal separator format to use for rational values depends on the corresponding setting “USB decimal separator” in the MENU

After every run of mode MPP4 the will provides 100 result sets of U, I and P, which could be read via digital interface or exported to USB stick. The latter will store a file (for naming scheme see section 1.9.6.4) for the user to evaluate with following format:

- Type CSV (text file)
- 100 rows with 3 columns which form a result set (column A: U, column B: I, column C: P)
- The decimal separator format used for rational values depends on the corresponding setting “USB decimal separator” in the MENU

The 100 result sets should contain with the highest power value (column C). This group of values either represents the true MPP, the maximum power point, or is at least close to it. It depends on the dissemination of the 100 voltage points on the expected MPP curve and between 0 V and U_{oc} .

The group with the MPP is also displayed as U_{mpp} , I_{mpp} and P_{mpp} and can also be read via digital interface separately.

3.10.15 Remote control of the function generator

The function generator can be remotely controlled but configuration and control of the functions with individual commands is different from manual operation. The external documentation “Programming Guide ModBus & SCPI” explains the approach. In general the following apply:

- The function generator is not controllable via the analog interface
- The function generator is unavailable if the device in UIR mode (resistance mode, CR)
- Some functions are based on the arbitrary generator, some on the XY generator, some are not based on any of both. Therefore, both generators have to be controlled and configured separately.
- Function “Battery test” is not available for remote control

3.11 Other applications

3.11.1 Parallel operation in master-slave (MS)

Multiple devices of same kind and model can be connected in parallel in order to create a system with higher total current and hence higher power. This can be done using the standard models with display and control panel or the new slave models (ELR 9000 HP Slave, available from mid 2018). These models are intended to run as slave only and thus have no display and cheaper. Only disadvantage: the slave models are only available as 15 kW versions, so they only match the 15 kW standard models.

For parallel operation in master-slave mode the units are usually connected with their DC inputs, their Share bus and their master-slave bus, which is a digital bus that makes the system work as one big unit regarding adjusted values, actual values and status.

The Share bus is intended to balance the units dynamically in their input current when running CV mode, especially if the master unit runs a function like sine wave etc. In order for this bus to work correctly, at least the DC minus poles of all units have to be connected, because DC minus is the reference for the Share bus.

Principle view (without source connected):

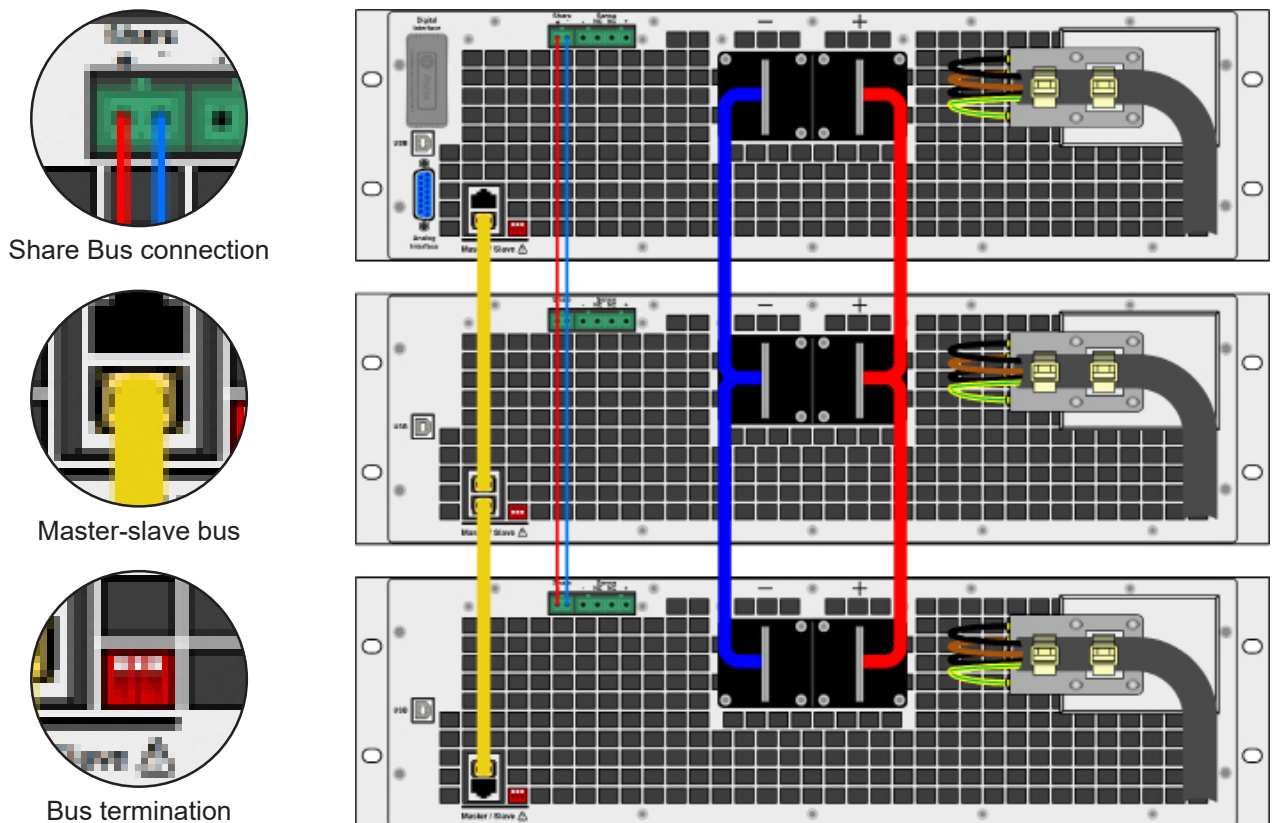

3.11.1.1 Restrictions

Compared to normal operation of a single device, master-slave operation has some limitations:

- The MS system reacts differently to alarm situations than a single unit (see below in 3.11.1.6)
- Using the Share bus makes the system reacts as dynamically as possible, but it is still not as dynamic as single unit operation
- A device which was configured as slave has limited operability (only access to MENU possible)

3.11.1.2 Wiring the DC inputs

The DC input of every unit in the parallel operation is simply connected to the next unit using cables with cross section according to the maximum current and with short as possible length.

3.11.1.3 Wiring the Share bus

The Share bus is wired from unit to unit with an ideally twisted pair of cables with non-critical cross section. We recommend to use 0.5 mm² to 1 mm².



- The Share bus is poled. Take care for correct polarity of the wiring!
- In order for the Share bus to work correctly it requires at least to connect all DC minus inputs of the devices



A max. of 16 units can be connected via Share bus.

3.11.1.4 Wiring and set-up of the master-slave bus

The master-slave connectors are built-in and must first be connected via network cables (\geq CAT3, patch cable) and then MS can be configured manually (recommended) or by remote control. The following applies:

- A maximum 16 units can be connected via the bus: 1 master and up to 15 slaves.
- Only devices of same kind, i.e. electronic load to electronic load, and of the same model, such as ELR 9080-170 HP to ELR 9080-170 HP.
- Units at the end of the bus must be terminated (see below)



The master-slave bus must not be wired using crossover cables!

Later operation of the MS system implies:

- The master unit displays, or makes available to be read by the remote controller, the sum of the actual values of all the units
- The ranges for setting the values, adjustment limits, protections (OVP etc.) and user events (UVD etc.) of the master are adapted to the total number of units. Thus, if e.g. 5 units each with a power of 5 kW are connected together to a 25 kW system, then the master can be set in the range 0...25 kW.
- Slaves are no operable as long as being controlled by the master
- Slave units will show the alarm “MSP” in the display as long as they not have been initialised by the master. The same alarm is signalled after a connection drop to the master unit occurred.

► How to connect the master-slave bus

1. Switch off all units that are to be connected and connect them together with a network cable (CAT3 or better, not included). It doesn't matter which of the two master-slave connection sockets (RJ45, backside) is connected to the next unit.
2. Also connect all units at the DC side.
3. The two units at the beginning and end of the chain should be terminated, if long connection cables are used. This is achieved using a 3-pole DIP switch which is positioned on the back side of the unit next to the MS connectors.



Now the master-slave system must be configured on each unit. It is recommended to configure first all the slave units and then the master unit.

► Step 1: Configuring all slave units (standard models with TFT display)



1. Enter **MENU** then GENERAL SETTINGS and press **▼** until reaching **Page 11**.
2. Activate the MS mode with touch area **SLAVE**. A warning requester will appear which has to be acknowledged with OK, otherwise the change will be reverted.
3. Accept the settings with the touch area **ENTER** and return to the main page.

► Step 1: Configuring all slave units (ELR 9000 HP Slave series models without display)

1. Connect the Slave series model via the rear USB port or via Ethernet interface to a PC.
2. Start the software Power Control (included with the device on USB stick) and let the software find the device.
3. Open the app “Settings” for the particular unit, change to tab “Master-Slave” and there set the parameter “Master-slave mode” to “SLAVE”.

The slave is then configured for master-slave. Repeat the procedure for all other slave units.

► Step 2: Configuring the master unit

1. Enter **MENU** then GENERAL SETTINGS and press  until reaching **Page 11**.
2. Specify the unit as master with touch area **MASTER**. A warning requester will appear which has to be acknowledged with OK, otherwise the change will be reverted.
3. Accept the settings with the touch area  and return to the main page.

► Step 3: Initialising the master

The master unit and the whole master-slave system still need to be initialised. In the main screen of the master unit, after quitting the setting menus, a pop-up will appear presenting the result of the first init run:



Tapping INITIALIZE will cause the master to search again for slaves and then to configure itself by setting all necessary parameters. If more than one correctly configured unit is found then this screen will show the number of slaves and the combined total current and total power.

If no slaves are found or the display number of detected slaves is not as expected, then the settings of the slaves and the master together with the cabling must be checked and the setup process repeated.



The initialising process of the master and the master-slave system will, as long as MS mode is still activated, be repeated each time the units are powered. The initialisation can be repeated anytime via the MENU in GENERAL SETTINGS, PAGE: 12.

3.11.1.5 Operating the master-slave system

After successful configuration and initialisation of the master and slave units, these will show their status in the displays. While the master merely shows "Master" in the status area, the slave(s) will continuously show like this, as long they are in remote control by the master:

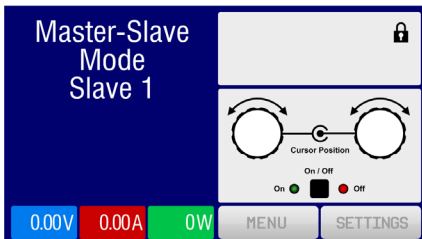

It means, as long as a slave unit is in control by the master, it won't display any set values, but actual values, and it will show the DC input status and possible alarms.

The slaves can no longer be controlled manually or remotely, neither via the analog nor via digital interfaces. They can, if needed, be monitored by reading actual values and status.

The display on the master unit changes after initialisation and all set values are reset. The master now displays the set and actual values of the total system. Depending on the number of units, the total current and power will multiply. The following applies:

- The master can be treated as a standalone unit
- The master shares the set values across the slaves and controls them
- The master is remotely controllable via the analog or digital interfaces
- All settings for the set values U, I and P (monitoring, settings limits etc.) will be adapted to the new total values
- All initialised slave will reset any limits (U_{Min} , I_{Max} etc.), supervision thresholds (OVP, OPP etc.) and event settings (UCD, OVD etc.) to default values, so these don't interfere the control by the master. As soon as these values are modified on the master, they are transferred 1:1 to the slaves. Later, during operation, it might occur that a slave causes an alarm or event rather than the master, due to imbalanced current or slightly faster reaction



In order to easily restore all these settings after leaving MS operation, it is recommended to make use of the user profiles (see „3.9. Loading and saving a user profile“)

- If one or more slaves report an device alarm, it will be displayed on the master and must be acknowledged there so that the slave(s) can continue their operation. Since most alarms cause the DC inputs to be switched off and the can only be reinstated on the master unit, user interaction (operator) may be required or alarm handling by a remote control software.

- Loss of connection to any slave will result in shutdown of all DC inputs, as a safety measure, and the master will report this situation in the display with a pop-up “Master-slave safety mode”. Then the MS system has to be re-initialised, either with or without re-establishing connection to the disconnected unit(s) before.
- All units, even the slaves, can be externally shut down on the DC inputs using the pin REM-SB of the analog interface. This can be used as some kind of emergency off, where usually a contact (maker or breaker) is wired to this pin on all units in parallel.

3.11.1.6 Alarms and other problem situations

Master-slave operation, due to the connection of multiple units and their interaction, can cause additional problem situations which do not occur when operating individual units. For such occurrences the following regulations have been defined:

- Generally, if the master loses connection to any slave, it will generate an MSP (master-slave protection) alarm, pop up a message on the screen and switch off its DC input. The slaves will fall back to single operation mode, but also switch off their DC input. The MSP alarm can be deleted by either initialising the master-slave system again. This can be done either in the MSP alarm pop-up screen or in the MENU of the master or via remote control. Alternatively, the alarm is also cleared by deactivating master-slave on the master unit
- If one or more slave units are switched off on the AC side (power switch, supply undervoltage) and come back later, they’re not automatically initialised and included again in the MS system. Then the init has to be repeated.
- If the DC input of the master unit is switched off due to a defect or overheating, then the total master-slave system can take no input power and the DC input of all slaves is automatically switched off, too.
- If accidentally multiple or no units are defined as master the master-slave system cannot be initialised.

In situations where one or multiple units generate a device alarm like OV, PF or OT following applies:

- Any alarm of a slave is indicated on the slave’s display and on the master’s display
- If multiple alarms happen simultaneously, the master only indicates the most recent one. In this case, the particular alarms can be read from the slave units displays. This also applies to remote control or remote supervision, because the master can only report the most recent alarm.
- All units in the MS system supervise their own values regarding overvoltage, overcurrent and overpower and in case of alarm they report the alarm to the master. In situations where the current is probably not balanced between the units, it can occur that one unit generates an OC alarm though the global OC limit of the MS system was not reached. The same can occur with the OP alarm.

3.11.1.7 Important to know



In case one or several units of a parallel system are not going to be used and remain switched off, depending on the number of active units and the dynamics of the operation it may become necessary to disconnect the inactive units from the Share bus, because even when not powered the units can have a negative impact on the Share bus due to their impedance.

3.11.2 Series connection



Series connection is not a permissible operating method for electronic loads and must not be installed or operated under any circumstances!

3.11.3 Two quadrants operation (2QO)

3.11.3.1 Introduction

This kind of operation refers to the use of a source, in this case a power supply from a compatible series (see section „1.9.10. Share connector“) and a sink, in this case a series ELR 9000 HP electronic load. The source and the sink function alternately in order to test a device, such as a battery, by deliberate charging and discharging as part of a functional test, or a motor by clipping excess energy with the sink.

The user can decide either to operate the system manually or only the power supply device as the driving unit or to control both devices by PC. It is recommended to focus on the power supply, which is intended to control the load via the Share Bus connection. The two quadrant operation is only suitable for constant voltage operation (CV).

Clarification:

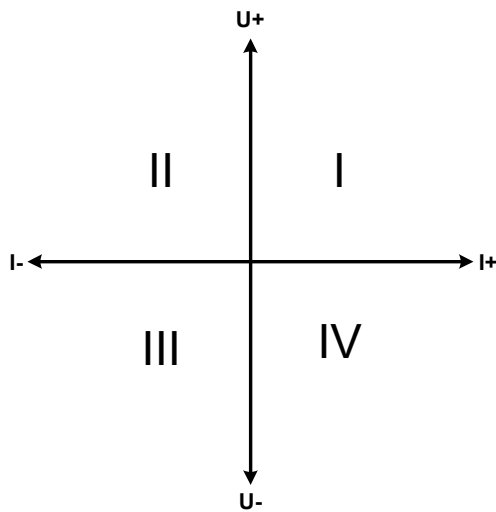
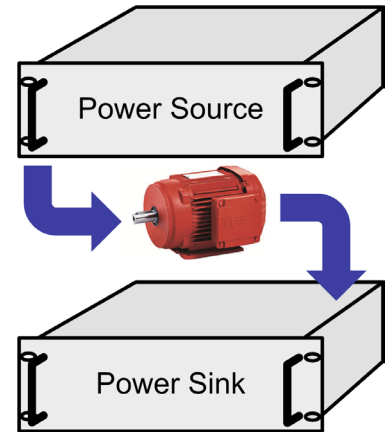

A combination of source and sink can only map the quadrants I + II. This means that only positive voltages are possible. The positive current is generated by the source or application and the negative current flows into the load.

The set values for current and power of the load need to be set to match the application’s requirements. This can be done manually or via any interface. The power supply has to be operating in mode CV. Only then it will control the input voltage of the load using the Share Bus.

Typical applications:

- Fuel cells
- Capacitor tests
- Motor driven applications
- Electronic tests where a high dynamic discharge is required.

3.11.3.2 Connecting devices to a 2QO

There are several ways to connect source(s) and sink(s) to make a 2QO:

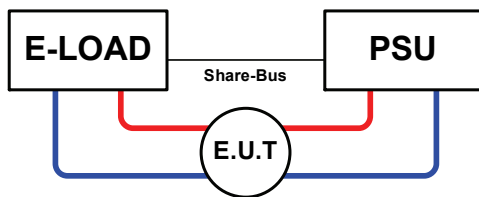

Configuration A:

1x e-load and 1x power supply, plus 1x test object (E.U.T).

This is the most common configuration for 2QO. The nominal values for U,I and P of the two devices should match, such as ELR 9080-170 HP and PSI 9080-170 3U. The characteristics of the 2QO system is determined by the power supply, which has to be set to “Master” in the setup menu, even if there is no master-slave operation running.

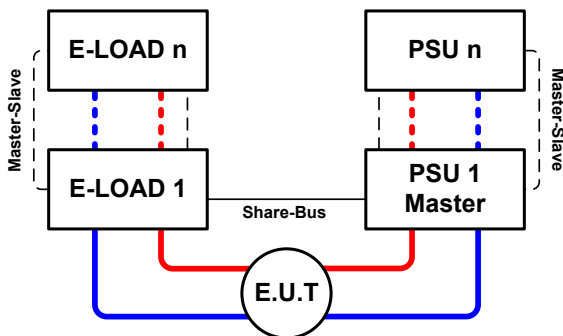

Configuration B:

Multiple e-loads and multiple power supplies for increased total performance, plus 1 test object (E.U.T).

The combination of load units and power supply units each create a block, a system with certain power. Here it is also necessary to match the nominal values of the two systems, like the 80 V DC input of the loads to a max. 80 V DC output of the power supplies. The max. number of 16 units cannot be exceeded. Regarding the Share bus connection, all e-load units have to be slaves, while one of the PSUs has to be set as master.

3.11.3.3 Settings on the devices

The master-slave settings in the MENU also affect the Share bus. For correct 2QO operation, all involved load units must be slaves on the Share bus. This is achieved by setting the master-slave mode to OFF or SLAVE, depending on if there is digital master-slave in use or not. For the one load that is master (setting: MASTER) in the master-slave system the additional parameter "PSI/ELR system" has to be activated.

On any of the power supplies, you need activate master-slave mode and set it to MASTER, unless it is already the master unit of a master-slave system over digital MS bus. Refer to the documentation of the power supply for further information. Also see 3.4.3.1.

For safety of the connected E.U.T / D.U.T and to prevent damage, we recommend to adjust supervision thresholds like OVP, OCP or OPP on all units to the desired levels, which will then switch off the DC output resp. the DC input in case of excess.

3.11.3.4 Restrictions

After all electronic loads have been connected to the Share bus with one power supply as master, they cannot limit their input voltage anymore to what you adjust as "U set" on the device. The correct voltage level comes from the master unit via Share bus and is thus adjusted there.

3.11.3.5 Application example

Charging and discharging a battery with 24 V/400 Ah, using the wiring example in configuration A.

- Power supply PSI 9080-170 3U with: $I_{Set} = 40$ A (charging current, usually 1/10 of battery capacity), $P_{Set} = 5000$ W
- Electronic load ELR 9080-170 HP set to: $I_{Set} = \text{max. discharge current of the battery (eg. 100 A)}$, $P_{Set} = 5000$ W, UVD = 20 V with event type "Alarm" to stop discharging at a certain low voltage threshold
- Assumption: the battery has a voltage of 26 V at test start
- DC inputs resp. DC outputs on all units switched off



In this combination of devices it is recommended to always switch on the DC output of the source first and then the DC input of the sink.

Part 1: Discharging the battery to 24 V

Setup: Voltage on the power supply set to 24 V, DC output of power supply and DC input of load activated

Reaction: the e-load will load the battery with a max. current of 100 A in order to discharge it to 24 V. The power supply delivers no current at this moment, because the battery voltage is still higher than what is adjusted on the power supply. The load will gradually reduce the input current in order to maintain the battery voltage at 24 V. Once the battery voltage has reached 24 V with a discharge current of approx. 0 A, the voltage will be maintained at this level by charging from the power supply.



The power supply determines the voltage setting of the load via the Share bus. In order to avoid deep discharge of the battery due to accidentally setting the voltage on the power supply to a very low value, it is recommended to configure the undervoltage detection feature (UVD) of the load, so it will switch off the DC input when reaching minimum allowed discharge voltage. The settings of the load, as given via the Share bus, can't be read from the load's display.

Part 2: Charging the battery to 27 V

Setup: Voltage on the power supply set to 27 V

Reaction: the power supply will charge the battery with a maximum current of 40 A, which will gradually reduce with increasing voltage as a reaction to the changing internal resistance of the battery. The load absorbs no current at this charging phase, because it is controlled via the Share and set to a certain voltage, which is still higher than the actual battery voltage and the actual output voltage of the power supply. When reaching 27 V, the power supply will deliver only the current needed to maintain the battery voltage.

4. Service and maintenance

4.1 Maintenance / cleaning

The device needs no maintenance. Cleaning may be needed for the internal fans, the frequency of cleanse is depending on the ambient conditions. The fans serve to cool the components which are heated by the inherent minimal power loss. Heavily dirt filled fans can lead to insufficient airflow and therefore the DC input would switch off too early due to overheating or possibly lead to defects.

Cleaning the internal fans can be performed with a vacuum cleaner or similar. For this the device needs to be opened.

4.2 Fault finding / diagnosis / repair

If the device suddenly performs in an unexpected way, which indicates a fault, or it has an obvious defect, this can not and must not be repaired by the user. Contact the supplier in case of suspicion and elicit the steps to be taken.

It will then usually be necessary to return the device to Intepro Systems (with or without warranty). If a return for checking or repair is to be carried out, ensure that:

- the supplier has been contacted and it is clarified how and where the device should be sent.
- the device is in fully assembled state and in suitable transport packaging, ideally the original packaging.
- optional extras such as an interface module is included if this is in any way connected to the problem.
- a fault description in as much detail as possible is attached.
- if shipping destination is abroad, the necessary customs papers are attached.

4.2.1 Firmware updates



Firmware updates should only be installed when they can eliminate existing bugs in the firmware in the device or contain new features.

The firmware of the control panel (HMI), of the communication unit (KE) and the digital controller (DR), if necessary, is updated via the rear side USB port. For this the software Power Control is needed which is included with the device or available as download from our website together with the firmware update, or upon request.

However, be advised not to install updates promptly. Every update includes the risk of an inoperable device or system. We recommend to install updates only if...

- an imminent problem with your device can directly be solved, especially if we suggested to install an update during a support case
- a new feature has been added which you definitely want to use. In this case, the full responsibility is transferred to you.

Following also applies in connection with firmware updates:

- Simple changes in firmwares can have crucial effects on the application the devices are use in. We thus recommend to study the list of changes in the firmware history very thoroughly.
- Newly implemented features may require an updated documentation (user manual and/or programming guide, as well as LabView VIs), which is often delivered only later, sometimes significantly later

4.3 Calibration

4.3.1 Preface

The devices of series ELR 9000 HP feature a function to re-adjust the most important DC input related values, which can help in case these have moved out of tolerance. The readjustment is intended to compensate small deviations of up to 1% or 2% rated value. There are several reasons which could make it necessary to re-adjust a unit: component aging, component deterioration, extreme ambient conditions, high frequent use.

In order to determine if a value is out of tolerance, the parameter must be verified first with measurement tools of high accuracy and with at least half the error of the ELR device. Only then a comparison between values displayed on the ELR device and true DC input values is possible.

For example, if you want to verify and possibly re-adjust the input current of model ELR 9080-510 HP which has 510 A maximum current, stated with a max. error of 0.4%, you can only do that by using a high current shunt with max. 0.2% error or less. Also, when measuring such high currents, it is recommended to keep the process short, in order to avoid the shunt heating up too much. It is furthermore recommended to use a shunt with at least 25% reserve.

When measuring the current with a shunt, the measurement error of the multimeter on the shunt adds to the error of the shunt and the sum of both must not exceed the given max. 0.4% of the device.

4.3.2 Preparation

For a successful calibration and re-adjustment, a few tools and certain ambient conditions are required:

- A measurement device (multimeter) for voltage, with a max. error of half the ELR's voltage error. That measurement device can also be used to measure the shunt voltage when re-adjusting the current
- If the current is also going to be calibrated: a suitable DC current shunt, ideally specified for at least 1.25 times the max. input current of the ELR and with a max. error that is half or less than the max. current error of the ELR device
- Normal ambient temperature of approx. 20-25 °C
- An adjustable voltage & current source which is capable of providing at least 102% of the max. voltage and current of the ELR device, or separate voltage source and current source units

Before starting the calibration procedure, a few measures have to be taken:

- Let the ELR device warm up for at least 10 minutes under 50% power, in connection with the voltage / current source
- In case the remote sensing input is going to be calibrated, prepare a cable for the remote sensing connector to DC input, but leave it yet unconnected
- Abort any form of remote control, deactivate master-slave mode, deactivate resistance mode
- Install the shunt between source and ELR device and make sure the shunt is cooled somehow. For example , you might want to place it in the warm air stream coming out of the rear of the ELR device. This helps the shunt to warm up as well to operation temperature
- Connect suitable measurement devices to the DC input and to the shunt, depending on whether the voltage is going to be calibrated first or the current

4.3.3 Calibration procedure

After the preparation, the device is ready to be calibrated. From now on, a certain sequence of parameter calibration is important. Generally, you don't need to calibrate all three parameters, but it is recommended to do so.

Important:



- *It is recommended to do the calibration of current before any voltage calibration*
- *When calibrating the voltage, the input "Sense" on the rear of the device must be disconnected*
- *During the calibration, the user is asked to enter measured values. If these value differ too much from the value measured by the device or wrong values are entered, the calibration fails and has to be repeated.*

The calibration procedure, as explained below, is an example with model ELR 9080-170 HP. Other models are treated the same way, with values according to the particular ELR model and the required power source.

4.3.3.1 Calibrating the set values

► How to calibrate the input voltage

1. Adjust the connected voltage source to approx. 102% of the maximum voltage specified for the ELR device. For the example with an 80 V ELR this would be 81.6 V for the source. Set the current limitation of the voltage source to 5% of the nominal current specified for ELR device, for this example it is 8.5 A. Check again, that for voltage calibration, the sensing connector on the rear of the device is not connected.
2. In the display, tap MENU, then „**General Settings**“, then go to **Page 9** and then tap **START**.
3. In the next screen select: **Voltage calibration**, then **Calibrate input value** and **NEXT**. The load will switch the DC input on and start to measure the input voltage (**U-mon**).
4. The next screen requests you to enter the measured input voltage at **Measured value=** from the multimeter. Enter it using the keypad, that appears when tapping the value. Assure yourself the value is correct and submit with **ENTER**.
5. Repeat point 4. for the next three steps (total of four steps).

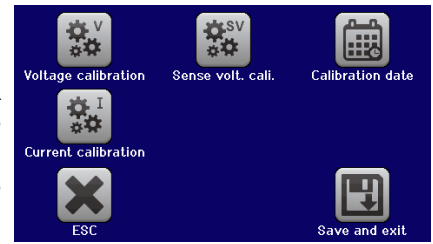

► How to calibrate the input current

1. Adjust the current source to approx. 102% nominal current of the ELR device, for the sample model with 170 A this would be 173.4 A, rounded to 174 A. Make sure the source can provide more current than the ELR can draw, else the source's voltage will collapse. Set the output voltage of the current source to 10% of the nominal voltage specified for ELR, in the example 8 V, and switch the DC output of the source on.
2. In the display, tap MENU, then „**General Settings**“, then go to **Page 9** and then tap **START**.
3. In the next screen select: **Current calibration**, then **Calibrate input value** and **NEXT**. The load will switch on the DC input and start to measure (**I-mon**).
4. The next screen requests you to enter the input current **Measured value=** measured with the shunt. Enter it using the keypad, assure yourself the value is correct and submit with **ENTER**.
5. Repeat point 4. for the next three steps (total of four steps).

4.3.3.2 Calibrating the remote sensing

In case you are generally using the remote sensing feature (Sense), it is recommended to readjust this parameter too, for best results. The procedure is identical to the calibration of voltage, except for it requires to have the sensing connector on the rear to be plugged and connected with correct polarity to the DC input of the ELR.

► How to calibrate the input voltage for remote sensing

1. Adjust the connected voltage source to approx. 102% of the maximum voltage specified for the ELR device. For example with an 80 V ELR this would be 81.6 V for the source. Set the current limitation of the voltage source to 5% of the nominal current specified for ELR device, for this example it is 8.5 A. Check again, that for sense voltage calibration, the sensing connector on the rear of the device is connected.
2. In the display, tap MENU, then „**General Settings**“, then go to **Page 9** and then tap **START**.
3. In the next screen select: **Sense volt. calibration**, then **Calibrate input value** and **NEXT**.
4. The next screen requests you to enter the measured sensing voltage **Measured value=** from the multimeter. Enter it using the keypad, that appears when tapping the value. Assure yourself the value is correct and submit with **ENTER**.
5. Repeat point 4. for the next three steps (total of four steps).

4.3.3.3 Calibrating the actual values

Actual values of the input voltage (with and without remote sensing) and the input current are calibrated almost the same way as the set values, but here you don't need to enter anything, but just confirm the displayed values. Please proceed the above steps and instead of "**Calibrate input value**" select "**Calibrate actual val.**" in the sub-menu. After the device shows the measured values on display, wait at least 2s for the measured value to settle and then tap **NEXT** until you are through all steps.

4.3.3.4 Save and exit

After calibration you may furthermore enter the current date as “calibration date” by tapping



in the selection screen and enter the date in format YYYY / MM / DD.

Last but not least save the calibration data permanently by tapping



 Leaving the calibration selection menu without “Save and exit” will discard calibration data and the procedure would have to be repeated!

5. Contact and support

5.1 Repairs

Repairs, if not otherwise arranged between supplier and customer, will be carried out by EA Elektro-Automatik. For this the device must generally be returned to the manufacturer. No RMA number is needed. It is sufficient to package the device adequately and send it, together with a detailed description of the fault and, if still under guarantee, a copy of the invoice, to the following address.

5.2 Contact options

Questions or problems with operation of the device, use of optional components, with the documentation or software, can be addressed to technical support either by telephone or e-Mail.

Address	e-Mail	Telephone
US: Intepro Systems America, LP 14662 Franklin Ave Suite E Tustin, CA 92780 UK: Intepro UK Ltd. 9 Lakeside Business Park Swan Lane, Sandhurst Berkshire GU479DN / UK China: Intepro Power Block 7 Fourth Industrial Area Nanyou, Nanshan District Shenzhen, China 518052	Technical support: service@inteproate.com All other issues: sales@inteproate.com	US Support: +1.714.953.2686 UK Support: +44.012.5287.5600 China Support: +0086 755 86500020

Contact Us

United States

Intepro Systems America, LP.
14662-E Franklin Ave
Tustin, CA 92780
Tel: 1-714-953-2686
sales@inteproate.com
www.inteproate.com

United Kingdom

Intepro UK Ltd.
9 Lakeside Business Park
Swan Lane, Sandhurst Berkshire
GU47 9DN / UK
Tel: 44 012 5287 5600

China

Intepro Power
Block 7 Fourth Industrial Area
Nanyou, Nanshan District
Shenzhen, China 518052
Tel: 0086 755 86500020