

User Manual

PS 9000 1U Series

DC Laboratory Power Supply



Attention! This document is only valid for devices with firmware "KE: 2.07" and "HMI: 2.03", or higher. For availability of updates for your device check our website or contact us.

INTEPRO
SYSTEMS

TABLE OF CONTENTS

1 GENERAL

1.1	About this document	5
1.1.1	Retention and use	5
1.1.2	Copyright	5
1.1.3	Validity	5
1.1.4	Explanation of symbols	5
1.2	Warranty	5
1.3	Limitation of liability	5
1.4	Disposal of equipment	6
1.5	Product key	6
1.6	Intended usage	6
1.7	Safety	7
1.7.1	Safety notices	7
1.7.2	Responsibility of the user	7
1.7.3	Responsibility of the operator	8
1.7.4	User requirements	8
1.7.5	Alarm signals	9
1.8	Technical data	9
1.8.1	Approved operating conditions	9
1.8.2	General technical data	9
1.8.3	Specific technical data	10
1.8.4	Views	14
1.9	Construction and function	18
1.9.1	General description	18
1.9.2	Block diagram	18
1.9.3	Scope of delivery	18
1.9.4	The control panel (HMI)	19
1.9.5	Sense connector (remote sensing)	20
1.9.6	USB port	21
1.9.7	Ethernet port	21
1.9.8	Analog interface	21
1.9.9	Share Bus-Connection	21

2 INSTALLATION & COMMISSIONING

2.1	Transport and storage	22
2.1.1	Transport	22
2.1.2	Packaging	22
2.1.3	Storage	22
2.2	Unpacking and visual check	22
2.3	Installation	22
2.3.1	Safety procedures before installation and use	22
2.3.2	Preparation	22
2.3.3	Installing the device	23
2.3.4	Connection to AC supply	23
2.3.5	Connection to DC loads	24
2.3.6	Grounding of the DC output	25
2.3.7	Connection of remote sensing	25
2.3.8	Connecting the "Share" bus	25
2.3.9	Connecting the analog interface	26
2.3.10	Connecting the USB port	26
2.3.11	Initial commission	26
2.3.12	Initial network setup	27

2.3.13	Commission after a firmware update or a long period of non-use	27
--------	--	----

3 OPERATION AND APPLICATION

3.1	Important notes	28
3.1.1	Personal safety	28
3.1.2	General	28
3.2	Operating modes	28
3.2.1	Voltage regulation / Constant voltage	28
3.2.2	Current regulation / constant current / current limiting	28
3.2.3	Power regulation / constant power / power limiting	29
3.3	Alarm conditions	30
3.3.1	Power Fail	30
3.3.2	Overtemperature	30
3.3.3	Overvoltage	30
3.3.4	Overcurrent	30
3.3.5	Overpower	30
3.4	Manual operation	31
3.4.1	Switching on the device	31
3.4.2	Switching off the device	31
3.4.3	Configuration in the setup menu	31
3.4.4	Adjustment limits	35
3.4.5	Display modes for actual and set values	36
3.4.6	Manual adjustment of set values	36
3.4.7	The quick menu	37
3.4.8	Switching the DC output on or off	37
3.5	Remote control	38
3.5.1	General	38
3.5.2	Control locations	38
3.5.3	Remote control via a digital interface	38
3.5.4	Remote control via the analog interface (AI)	39
3.6	Alarms and monitoring	43
3.6.1	Definition of terms	43
3.6.2	Device alarm handling	43
3.7	Control panel (HMI) lock	44
3.8	Loading and saving a user profile	45
3.9	Other applications	46
3.9.1	Parallel operation in Share Bus mode	46
3.9.2	Series connection	47
3.9.3	Operation as battery charger	47
3.9.4	Two quadrants operation (2QO)	48
4.	SERVICE AND MAINTENANCE	
4.1	Maintenance / cleaning	50
4.2	Fault finding / diagnosis / repair	50
4.2.1	Replacing a defect mains fuse	50
4.2.2	Firmware updates	50
4.3.1	Update of control panel (HMI)	50
4.3.2	Update of communication unit (KE)	50

4.3	Calibration (readjustment)	51
4.3.1	Preface	51
4.3.1.1	Preparation.....	51
4.3.2	Calibration procedure	51

5 CONTACT AND SUPPORT

5.1	General.....	53
5.2	Contact Options	53

1. General

1.1 About this document

1.1.1 Retention and use

This document is to be kept near the equipment for future reference and explanation of the operation of the device. This document is to be delivered and kept with the equipment in case of change of location and/or user.

1.1.2 Copyright

All information in this manual is copyrighted by Intepro Systems. Reprinting or copying in whole or part, and use of this manual for other purposes is forbidden and breach may lead to legal process.

1.1.3 Validity



This manual is valid for the following equipment including derived variants.

Model	Article nr.	Model	Article nr.
PS 9080-50 1U	06230400	PS 9080-100 1U	06230405
PS 9200-25 1U	06230401	PS 9200-50 1U	06230406
PS 9360-15 1U	06230402	PS 9360-30 1U	06230407
PS 9500-10 1U	06230403	PS 9500-20 1U	06230408
PS 9750-06 1U	06230404	PS 9750-12 1U	06230409

Changes and modifications for special models will be listed in a separate document.

1.1.4 Explanation of symbols

Warning and safety notices as well as general notices in this document are shown in a box with a symbol as follows:

	Symbol for a life threatening danger
	Symbol for general safety notices (instructions and damage protection bans) or important information for operation
	Symbol for general notices

1.2 Warranty

Intepro Systems guarantees the functional competence of the applied technology and the stated performance parameters. The warranty period begins with the delivery of free from defects equipment.

Terms of guarantee are included in the general terms and conditions of Intepro Systems.

1.3 Limitation of liability

All statements and instructions in this manual are based on current norms and regulations, up-to-date technology and our long term knowledge and experience. Intepro Systems accepts no liability for losses because of:

- Use for purposes other than defined
- Use by untrained personnel
- Rebuilding by the customer
- Technical changes
- Use of non-authorized spare parts

The actual delivered device(s) may differ from the explanations and diagrams given here because of the latest technical changes or customized models that include additional ordered options.

PS 9000 1U Series

1.4 Disposal of equipment

Any equipment intended for disposal must, according to applicable laws and regulations, be returned to Intepro Systems for scrapping, unless the person operating the piece of equipment or another, delegated person is conducting the disposal. Our equipment falls under these regulations and is accordingly marked with the following symbol:



1.5 Product key

Decoding of the product description on the label, using an example:

PS 9 080 - 50 1U zzz

Field for identification of installed options and/or special models S01...S0x = Special models
Construction (not always given) 1U / 2U / 3U = 19" frame with 1 U, 2 U or 3 U
Maximum current of the device in Ampere
Maximum voltage of the device in Volt
Series : 8 = Series 8000 or 800, 9 = Series 9000
Type identification: PS = Power Supply, usually programmable PSI = Power Supply Intelligent, always programmable ELR = Electronic Load with Recovery



Special models are always derived from standard models and can vary in output voltage and current from those given.

1.6 Intended usage

The equipment is intended to be used, if a power supply or battery charger, only as a variable voltage and current source, or, if an electronic load, only as a variable current sink.

Typical application for a power supply is DC supply to any relevant user, for a battery charger the charging of various battery types and for electronic loads the replacement of Ohm resistance by an adjustable DC current sink in order to load relevant voltage and current sources of any type.



- Claims of any sort due to damage caused by unintended use will not be accepted.
- All damage caused by unintended use is solely the responsibility of the operator.

1.7 Safety

1.7.1 Safety notices

Mortal danger - Hazardous voltage



- Electrical equipment operation means that some parts will involve dangerous voltage. Therefore all parts under voltage must be covered!
- All work on connections must be carried out under zero voltage (output not connected to load) and may only be performed by qualified and informed persons. Improper actions can cause fatal injury as well as serious material damage!
- Never touch cables or connectors directly after unplugging from mains supply as the danger of electric shock remains!
- Never touch the contacts on DC output terminal directly after switching off the DC output, because there still can dangerous voltage present, sinking more or less slowly depending on the load! There can be dangerous potential between negative DC output to PE or positive DC output to PE because of charged X capacitors.



- The equipment must only be used as intended
- The equipment is only approved for use within the connection limits stated on the product label.
- Do not insert any object, particularly metallic, through the ventilator slots
- Avoid any use of liquids near the equipment. Protect the device from wet, damp and condensation.
- For power supplies and battery chargers: do not connect users, particularly low resistance, to devices under power; sparking may occur which can cause burns as well as damage to the equipment and to the user.
- For electronic loads: do not connect power sources to equipment under power, sparking may occur which can cause burns as well as damage to the equipment and to the source.
- ESD regulations must be applied when plugging interface cards or modules into the relative slot
- Interface cards or modules may only be attached or removed after the device is switched off. It is not necessary to open the device.
- Do not connect external power sources with reversed polarity to DC input or outputs! The equipment will be damaged.
- For power supply devices: avoid where possible connecting external power sources to the DC output, and never those that can generate a higher voltage than the nominal voltage of the device.
- For electronic loads: do not connect a power source to the DC input which can generate a voltage more than 120% of the nominal input voltage of the load. The equipment is not protected against over voltage and may be irreparably damaged.
- Never insert a network cable which is connected to Ethernet or its components into the master-slave socket on the back side of the device!
- Always configure the various protecting features against overvoltage, overpower, etc. for sensitive loads to what the currently-used application requires

1.7.2 Responsibility of the user

The equipment is an industrial application and as such is governed by all legal safety regulations. In addition to the warning and safety notices in this manual all relevant safety, accident prevention and environmental regulations shall also apply. The users of the equipment shall:

- be informed of the relevant job safety requirements
- work to the defined responsibilities for operation, maintenance and cleaning of the equipment
- have read and understood the operating manual before starting work
- use the designated and recommended safety equipment.

Additionally, anyone working with the equipment is responsible for ensuring that the device is at all times technically fit for use.

1.7.3 Responsibility of the operator

The operator is any natural or legal person who uses the equipment or delegates the usage to a third party, and is responsible during its usage for the safety of the user, other personnel or third parties.

The equipment is an industrial application and as such is governed by all legal safety regulations. In addition to the warning and safety notices in this manual all relevant safety, accident prevention and environmental regulations shall also apply. In particular the operator shall:

- be acquainted with the relevant job safety requirements
- identify other possible dangers arising from the specific usage conditions at the work station via a risk assessment
- introduce the necessary steps in the operating procedures for the local conditions
- regularly control that the operating procedures are current
- update the operating procedures where necessary to reflect changes in regulation, standards or operating conditions.
- define clearly and unambiguously the responsibilities for operation, maintenance and cleaning of the equipment.
- ensure that all employees who use the equipment have read and understood the manual. Furthermore the users are to be regularly schooled in working with the equipment and the possible dangers.
- provide all personnel who work with the equipment with the designated and recommended safety equipment

Furthermore, the operator is responsible for ensuring that the device is at all times technically fit for use.

1.7.4 User requirements

Any activity with equipment of this type may only be performed by persons who are able to work correctly and reliably and satisfy the requirements of the job.

- Persons whose reaction capability is negatively influenced by e.g. drugs, alcohol or medication may not operate the equipment.
- Age or job-related regulations valid at the operating site must always be applied.



Danger for unqualified users

Improper operation can cause person or object damage. Only persons who have the necessary training, knowledge and experience may use the equipment.

Delegated persons are those who have been properly and demonstrably instructed in their tasks and the attendant dangers.

Qualified persons are those who are able through training, knowledge and experience as well as knowledge of the specific details to carry out all the required tasks, identify dangers and avoid personal and other risks.

1.7.5 Alarm signals

The equipment offers various possibilities for signalling alarm conditions, however, not for danger situations. The signals may be optical (on the display as text) acoustic (piezo buzzer) or electronic (pin/status output of an analog interface). All alarms will cause the device to permanently or temporarily switch off the DC output.

The meaning of the signals is as follows:

Signal OT (OverTemperature)	<ul style="list-style-type: none"> • Overheating of the device • DC output will be switched off temporarily • Non-critical
Signal OVP (OverVoltage)	<ul style="list-style-type: none"> • Overvoltage shutdown of the DC output due to high voltage entering the device or generated by the device itself due to a defect or because the adjusted OVP threshold was lower than the actual output voltage • Critical! The device and/or the load could be damaged
Signal OCP (OverCurrent)	<ul style="list-style-type: none"> • Shutdown of the DC output due to excess of the preset limit • Non-critical, protects the load from excessive current consumption
Signal OPP (OverPower)	<ul style="list-style-type: none"> • Shutdown of the DC output due to excess of the preset limit • Non-critical, protects the load from excessive power consumption
Signal PF (Power Fail)	<ul style="list-style-type: none"> • DC output shutdown due to AC undervoltage or defect of the AC input circuit • Critical on overvoltage! AC input circuit could be damaged

1.8 Technical data

1.8.1 Approved operating conditions

- Use only inside dry buildings
- Ambient temperature 0-50°C
- Operational altitude: max. 2000 m above sea level
- Max 80% RH up to 30°C, linear decrease to 50% RH at 50°C

1.8.2 General technical data

Display: Dot matrix, 240pt x 64pt

Controls: 2 rotary knobs with button function, 6 pushbuttons

The nominal values for the device determine the maximum adjustable ranges.

PS 9000 1U Series

1.8.3 Specific technical data

1500 W	Model 1U				
	PS 9080-50	PS 9200-25	PS 9360-15	PS 9500-10	PS 9750-06
AC Input					
Input voltage (w/o derating)	150...264 V AC	150...264 V AC	150...264 V AC	150...264 V AC	150...264 V AC
Input voltage (w/ derating)	1000 W 100...150 VAC	1000 W 100...150 VAC	1000 W 100...150 VAC	1000 W 100...150 VAC	1000 W 100...150 VAC
Input connection	1ph,N,PE	1ph,N,PE	1ph,N,PE	1ph,N,PE	1ph,N,PE
Input frequency	50/60 Hz	50/60 Hz	50/60 Hz	50/60 Hz	50/60 Hz
Input fuse (internal)	T16 A	T16 A	T16 A	T16 A	T16 A
Leak current	< 3.5 mA	< 3.5 mA	< 3.5 mA	< 3.5 mA	< 3.5 mA
Power factor	~ 0.99	~ 0.99	~ 0.99	~ 0.99	~ 0.99
Idle mode power consumption	~ 70 W	~ 70 W	~ 70 W	~ 70 W	~ 70 W
DC Output					
Max. output voltage U_{Max}	80 V	200 V	360 V	500 V	750 V
Max. output current I_{Max}	50 A	25 A	15 A	10 A	6 A
Max. output power P_{Max}	1500 W	1500 W	1500 W	1500 W	1500 W
Overvoltage protection range	0...88 V	0...220 V	0...396 V	0...550 V	0...825 V
Overcurrent protection range	0...55 A	0...27,5 A	0...17,6 A	0...11 A	0...6,6 A
Overpower protection range	0...1650 W	0...1650 W	0...1650 W	0...1650 W	0...1650 W
Temperature coefficient	Voltage / current: 100 ppm/K				
Output capacitance (approx.)	5640 μ F	1000 μ F	470 μ F	105 μ F	49 μ F
Voltage regulation					
Adjustment range	0...81.6 V	0...204 V	0...367.2 V	0...510 V	0...765 V
Accuracy ⁽¹⁾ (at 23 \pm 5°C)	< 0.1% U_{Nenn}	< 0.1% U_{Nenn}	< 0.1% U_{Nenn}	< 0.1% U_{Nenn}	< 0.1% U_{Nenn}
Line regulation at $\pm 10\%$ ΔU_{AC}	< 0.02% U_{Nenn}	< 0.02% U_{Nenn}	< 0.02% U_{Nenn}	< 0.02% U_{Nenn}	< 0.02% U_{Nenn}
Load regulation at 0...100% load	< 0.05% U_{Nenn}	< 0.05% U_{Nenn}	< 0.05% U_{Nenn}	< 0.05% U_{Nenn}	< 0.05% U_{Nenn}
Rise time 10...90% ΔU	Max. 15 ms	Max. 15 ms	Max. 15 ms	Max. 15 ms	Max. 15 ms
Transient time after load step	< 1.7 ms	< 1.4 ms	< 2.2 ms	< 2 ms	< 2 ms
Display: Resolution	See section "1.9.4.4. Resolution of the displayed values"				
Display: Accuracy ⁽³⁾	$\leq 0.2\%$ U_{Nom}	$\leq 0.2\%$ U_{Nom}	$\leq 0.2\%$ U_{Nom}	$\leq 0.2\%$ U_{Nom}	$\leq 0.2\%$ U_{Nom}
Ripple ⁽²⁾	< 100 mV _{PP} < 5.2 mV _{RMS}	< 293 mV _{PP} < 51 mV _{RMS}	< 195 mV _{PP} < 33 mV _{RMS}	< 293 mV _{PP} < 63 mV _{RMS}	< 260 mV _{PP} < 40 mV _{RMS}
Remote sensing compensation	Max. 5% U_{Nenn}	Max. 5% U_{Nenn}	Max. 5% U_{Nenn}	Max. 5% U_{Nenn}	Max. 5% U_{Nenn}
Fall time (at no load) after switching DC output off	Down from 100% to <60 V: less than 10 s				
Current regulation					
Adjustment range	0...51 A	0...25.5 A	0...15.3 A	0...10.2 A	0...6.12 A
Accuracy ⁽¹⁾ (at 23 \pm 5°C)	< 0.2% I_{Nom}	< 0.2% I_{Nom}	< 0.2% I_{Nom}	< 0.2% I_{Nom}	< 0.2% I_{Nom}
Line regulation at $\pm 10\%$ ΔU_{AC}	< 0.05% I_{Nom}	< 0.05% I_{Nom}	< 0.05% I_{Nom}	< 0.05% I_{Nom}	< 0.05% I_{Nom}
Load regulation at 0...100% ΔU_{OUT}	< 0.15% I_{Nom}	< 0.15% I_{Nom}	< 0.15% I_{Nom}	< 0.15% I_{Nom}	< 0.15% I_{Nom}
Ripple ⁽²⁾	< 75 mA _{PP}	< 29 mA _{PP}	< 10 mA _{PP}	< 9.2 mA _{PP}	< 4.1 mA _{PP}
Display: Resolution	See section "1.9.4.4. Resolution of the displayed values"				
Display: Accuracy ⁽³⁾	$\leq 0.2\%$ I_{Nom}	$\leq 0.2\%$ I_{Nom}	$\leq 0.2\%$ I_{Nom}	$\leq 0.2\%$ I_{Nom}	$\leq 0.2\%$ I_{Nom}
Power regulation					
Adjustment range	0...1530 W	0...1530 W	0...1530 W	0...1530 W	0...1530 W
Accuracy ⁽¹⁾ (at 23 \pm 5°C)	< 1% P_{Nom}	< 1% P_{Nom}	< 1% P_{Nom}	< 1% P_{Nom}	< 1% P_{Nom}
Line regulation at $\pm 10\%$ ΔU_{AC}	< 0.05% P_{Nom}	< 0.05% P_{Nom}	< 0.05% P_{Nom}	< 0.05% P_{Nom}	< 0.05% P_{Nom}
Load regulation at 10-90% $\Delta U \cdot \Delta I$	< 0.75% P_{Nom}	< 0.75% P_{Nom}	< 0.75% P_{Nom}	< 0.75% P_{Nom}	< 0.75% P_{Nom}
Display: Resolution	See section "1.9.4.4. Resolution of the displayed values"				
Efficiency at 100% U_{DC}	~ 91%	~ 93%	~ 94%	~ 94%	~ 95%
Efficiency at 100% I_{DC}	~ 89%	~ 90%	~ 92%	~ 92%	~ 94%

(1) Related to the nominal values, the accuracy defines the maximum deviation between an adjusted values and the true (actual) value.
Example: a 80 V model has min. 0.1% voltage accuracy, that is 80 mV. When adjusting the voltage to 5 V, the actual value is allowed to differ max. 80 mV, which means it might be between 4.92 V and 5.08 V.

(2) RMS value: LF 0...300 kHz, PP value: HF 0...20MHz

(3) The display error adds to the error of the related actual value on the DC output

1500 W		Model 1U				
		PS 9080-50	PS 9200-25	PS 9360-15	PS 9500-10	PS 9750-06
Analog interface ⁽¹⁾						
Type		Sub-D, 15 pole, female				
Set value inputs		U, I, P	U, I, P	U, I, P	U, I, P	U, I, P
Actual value output		U, I	U, I	U, I	U, I	U, I
Control signals		DC on/off, Remote on/off	DC on/off, Remote on/off	DC on/off, Remote on/off	DC on/off, Remote on/off	DC on/off, Remote on/off
Status signals		CV, OVP, OT	CV, OVP, OT	CV, OVP, OT	CV, OVP, OT	CV, OVP, OT
Galvanic isolation to the device		Max. 1500 V DC	Max. 1500 V DC	Max. 1500 V DC	Max. 1500 V DC	Max. 1500 V DC
Insulation		Allowed float (potential shift) on the DC output:				
Negative terminal to PE	Max.	±400 V DC	±400 V DC	±400 V DC	±400 V DC	±400 V DC
Positive terminal to PE	Max.	+480 V DC	+600 V DC	+760 V DC	+900 V DC	+1150 V DC
Miscellaneous						
Cooling		Temperature controlled fans, front inlet, rear exhaust				
Ambient temperature		0..50°C				
Storage temperature		-20...70°C				
Humidity		< 80%, not condensing				
Standards		EN 61010, EN 61326				
Overvoltage category		2				
Protection class		1				
Pollution degree		2				
Operational altitude		< 2000 m				
Digital interfaces						
Featured		1x USB-B, 1x Ethernet				
Galvanic isolation from device		Max. 1500 V DC				
USB specification		USB 2.0, socket type B, VCOM driver				
USB response time		SCPI: max. 5 ms, ModBus: max. 5 ms				
Ethernet specification		RJ45, 10/100Mbit, TCP/IP, ICMP, HTTP, DHCP				
Ethernet response time		SCPI: max. 7 ms, ModBus: 9-17 ms				
Terminals						
Rear side		Share Bus, DC output, AC input, remote sensing, analog interface, USB-B, Ethernet				
Dimensions						
Enclosure (WxHxD)		19" x 1U x 463 mm				
Total (WxHxD)		483 x 44 x min. 565 mm				
Weight		~ 10.5 kg	~ 10.5 kg	~ 10.5 kg	~ 10.5 kg	~ 10.5 kg
Article number		06230400	06230401	06230402	06230403	06230404

(1 For technical specifications of the analog interface see "3.5.4.3 Analog interface specification" on page 40

PS 9000 1U Series

3000 W	Model 1U				
	PS 9080-100	PS 9200-50	PS 9360-30	PS 9500-20	PS 9750-12
AC Input					
Input voltage (w/o derating)	207...264 V AC	207...264 V AC	207...264 V AC	207...264 V AC	207...264 V AC
Input voltage (w/ derating)	2500 W 180..207 VAC	2500 W 180..207 VAC	2500 W 180..207 VAC	2500 W 180..207 VAC	2500 W 180..207 VAC
Input connection	1ph,N,PE	1ph,N,PE	1ph,N,PE	1ph,N,PE	1ph,N,PE
Input frequency (w/ derating)	45...66 Hz	45...66 Hz	45...66 Hz	45...66 Hz	45...66 Hz
Input fuse (internal)	T16 A	T16 A	T16 A	T16 A	T16 A
Leak current	< 3.5 mA	< 3.5 mA	< 3.5 mA	< 3.5 mA	< 3.5 mA
Power factor	~ 0.99	~ 0.99	~ 0.99	~ 0.99	~ 0.99
Idle mode power consumption	~ 70 W	~ 70 W	~ 70 W	~ 70 W	~ 70 W
DC Output					
Max. output voltage U_{Max}	80 V	200 V	360 V	500 V	750 V
Max. output current I_{Max}	100 A	50 A	30 A	20 A	12 A
Max. output power P_{Max}	3000 W	3000 W	3000 W	3000 W	3000 W
Overvoltage protection range	0...88 V	0...220 V	0...396 V	0...550 V	0...825 V
Overcurrent protection range	0...110 A	0...55 A	0...33 A	0...22 A	0...13,2 A
Overpower protection range	0...3300 W	0...3300 W	0...3300 W	0...3300 W	0...3300 W
Temperature coefficient	Voltage / current: 100 ppm/K				
Output capacitance (approx.)	8930 μ F	1500 μ F	705 μ F	150 μ F	70 μ F
Voltage regulation					
Adjustment range	0...81.6 V	0...204 V	0...367.2 V	0...510 V	0...765 V
Accuracy ⁽¹⁾ (at 23 \pm 5°C)	< 0.1% U_{Nenn}	< 0.1% U_{Nenn}	< 0.1% U_{Nenn}	< 0.1% U_{Nenn}	< 0.1% U_{Nenn}
Line regulation at $\pm 10\%$ ΔU_{AC}	< 0.02% U_{Nenn}	< 0.02% U_{Nenn}	< 0.02% U_{Nenn}	< 0.02% U_{Nenn}	< 0.02% U_{Nenn}
Load regulation at 0...100% load	< 0.05% U_{Nenn}	< 0.05% U_{Nenn}	< 0.05% U_{Nenn}	< 0.05% U_{Nenn}	< 0.05% U_{Nenn}
Rise time 10...90% ΔU	Max. 15 ms	Max. 15 ms	Max. 15 ms	Max. 15 ms	Max. 15 ms
Transient time after load step	< 1.7 ms	< 1.4 ms	< 2.2 ms	< 2 ms	< 2 ms
Display: Resolution	See section "1.9.4.4. Resolution of the displayed values"				
Display: Accuracy ⁽³⁾	$\leq 0.2\%$ U_{Nom}	$\leq 0.2\%$ U_{Nom}	$\leq 0.2\%$ U_{Nom}		
Ripple ⁽²⁾	< 76 mV _{PP} < 4.2 mV _{RMS}	< 234 mV _{PP} < 40 mV _{RMS}	< 156 mV _{PP} < 26 mV _{RMS}	< 234 mV _{PP} < 50 mV _{RMS}	< 260 mV _{PP} < 40 mV _{RMS}
Remote sensing compensation	Max. 5% U_{Nom}	Max. 5% U_{Nom}	Max. 5% U_{Nom}	Max. 5% U_{Nom}	Max. 5% U_{Nom}
Fall time (at no load) after switching DC output off	Down from 100% to <60 V: less than 10 s				
Current regulation					
Adjustment range	0...102 A	0...51 A	0...30.6 A	0...20.4 A	0...12.24 A
Accuracy ⁽¹⁾ (at 23 \pm 5°C)	< 0.2% I_{Nenn}	< 0.2% I_{Nenn}	< 0.2% I_{Nenn}	< 0.2% I_{Nenn}	< 0.2% I_{Nenn}
Line regulation at $\pm 10\%$ ΔU_{AC}	< 0.05% I_{Nenn}	< 0.05% I_{Nenn}	< 0.05% I_{Nenn}	< 0.05% I_{Nenn}	< 0.05% I_{Nenn}
Load regulation at 0...100% ΔU_{OUT}	< 0.15% I_{Nenn}	< 0.15% I_{Nenn}	< 0.15% I_{Nenn}	< 0.15% I_{Nenn}	< 0.15% I_{Nenn}
Ripple ⁽²⁾	< 114 mA _{PP}	< 29 mA _{PP}	< 10 mA _{PP}	< 9.2 mA _{PP}	< 4.1 mA _{PP}
Display: Resolution	See section "1.9.4.4. Resolution of the displayed values"				
Display: Accuracy ⁽³⁾	$\leq 0.2\%$ I_{Nom}	$\leq 0.2\%$ I_{Nom}	$\leq 0.2\%$ I_{Nom}	$\leq 0.2\%$ I_{Nom}	$\leq 0.2\%$ I_{Nom}
Power regulation					
Adjustment range	0...3060 W	0...3060 W	0...3060 W	0...3060 W	0...3060 W
Accuracy ⁽¹⁾ (at 23 \pm 5°C)	< 1% P_{Nenn}	< 1% P_{Nenn}	< 1% P_{Nenn}	< 1% P_{Nenn}	< 1% P_{Nenn}
Line regulation at $\pm 10\%$ ΔU_{AC}	< 0.05% P_{Nenn}	< 0.05% P_{Nenn}	< 0.05% P_{Nenn}	< 0.05% P_{Nenn}	< 0.05% P_{Nenn}
Load regulation at 10-90% $\Delta U * \Delta I$	< 0.75% P_{Nenn}	< 0.75% P_{Nenn}	< 0.75% P_{Nenn}	< 0.75% P_{Nenn}	< 0.75% P_{Nenn}
Display: Resolution	See section "1.9.4.4. Resolution of the displayed values"				
Efficiency at 100% U_{DC}	~ 91%	~ 93%	~ 94%	~ 94%	~ 95%
Efficiency at 100% I_{DC}	~ 89%	~ 90%	~ 92%	~ 92%	~ 94%

(1) Related to the nominal values, the accuracy defines the maximum deviation between an adjusted values and the true (actual) value.

Example: a 80 V model has min. 0.1% voltage accuracy, that is 80 mV. When adjusting the voltage to 5 V, the actual value is allowed to differ max. 80 mV, which means it might be between 4.92 V and 5.08 V.

(2) RMS value: LF 0...300 kHz, PP value: HF 0...20MHz

(3) The display error adds to the error of the related actual value on the DC output

3000 W		Model 1U				
		PS 9080-100	PS 9200-50	PS 9360-30	PS 9500-20	PS 9750-12
Analog interface ⁽¹⁾						
Type		Sub-D, 15 pole, female				
Set value inputs		U, I, P	U, I, P	U, I, P	U, I, P	U, I, P
Actual value output		U, I	U, I	U, I	U, I	U, I
Control signals		DC on/off, Remote on/off	DC on/off, Remote on/off	DC on/off, Remote on/off	DC on/off, Remote on/off	DC on/off, Remote on/off
Status signals		CV, OVP, OT	CV, OVP, OT	CV, OVP, OT	CV, OVP, OT	CV, OVP, OT
Galvanic isolation to the device		Max. 1500 V DC	Max. 1500 V DC	Max. 1500 V DC	Max. 1500 V DC	Max. 1500 V DC
Insulation		Allowed float (potential shift) on the DC output:				
Negative terminal to PE	Max.	±400 V DC	±400 V DC	±400 V DC	±400 V DC	±400 V DC
Positive terminal to PE	Max.	+480 V DC	+600 V DC	+760 V DC	+900 V DC	+1150 V DC
Miscellaneous						
Cooling		Temperature controlled fans, front inlet, rear exhaust				
Ambient temperature		0..50°C				
Storage temperature		-20...70°C				
Humidity		< 80%, not condensing				
Standards		EN 61010, EN 61326				
Overvoltage category		2				
Protection class		1				
Pollution degree		2				
Operational altitude		< 2000 m				
Digital interfaces						
Featured		1x USB-B, 1x Ethernet				
Galvanic isolation from device		Max. 1500 V DC				
USB specification		USB 2.0, socket type B, VCOM driver				
USB response time		SCPI: max. 5 ms, ModBus: max. 5 ms				
Ethernet specification		RJ45, 10/100Mbit, TCP/IP, ICMP, HTTP, DHCP				
Ethernet response time		SCPI: max. 7 ms, ModBus: 9-17 ms				
Terminals						
Rear side		Share Bus, DC output, AC input, remote sensing, analog interface, USB-B, Ethernet				
Dimensions						
Enclosure (WxHxD)		19" x 1U x 463 mm				
Total (WxHxD)		483 x 44 x min. 565 mm				
Weight		~ 11 kg	~ 11 kg	~ 11 kg	~ 11 kg	~ 11 kg
Article number		06230405	06230406	06230407	06230408	06230409

(1 For technical specifications of the analog interface see "3.5.4.3 Analog interface specification" on page 40

1.8.4 Views

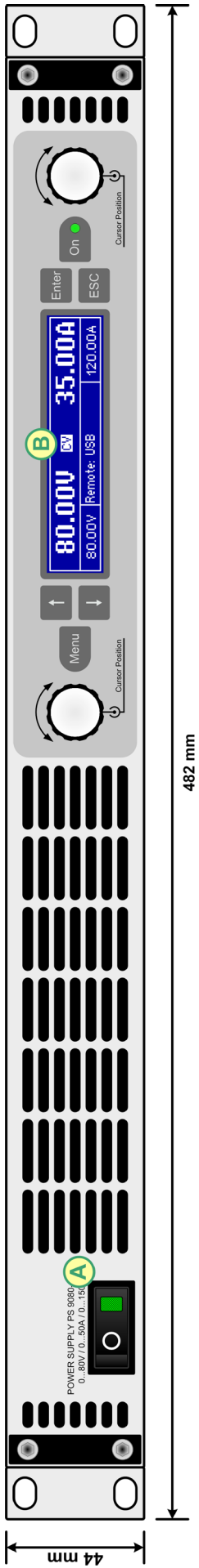

Figure 1 - Front side

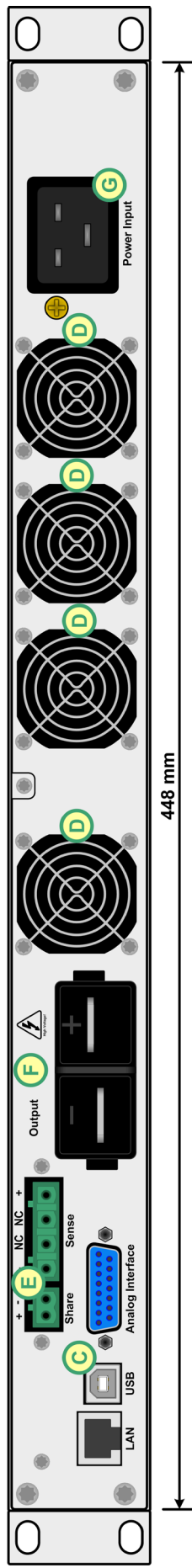

Figure 2 - Rear side

- A - Mains switch
- B - Control panel
- C - Control interfaces (digital, analog)
- D - Exhausts
- E - Share Bus and remote sensing connectors
- F - DC output
- G - AC input connector

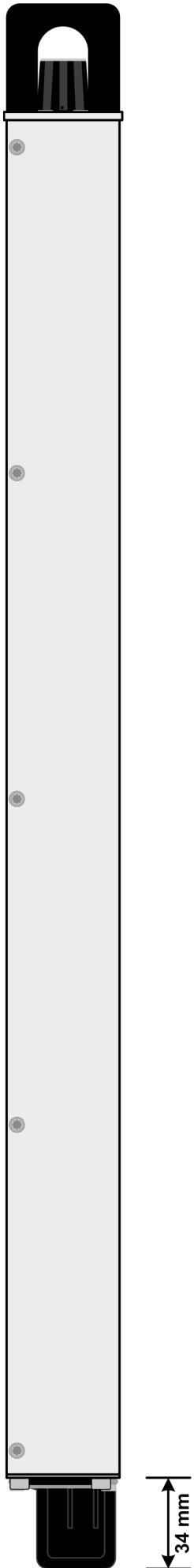

Figure 3 - Left hand side view with DC cover

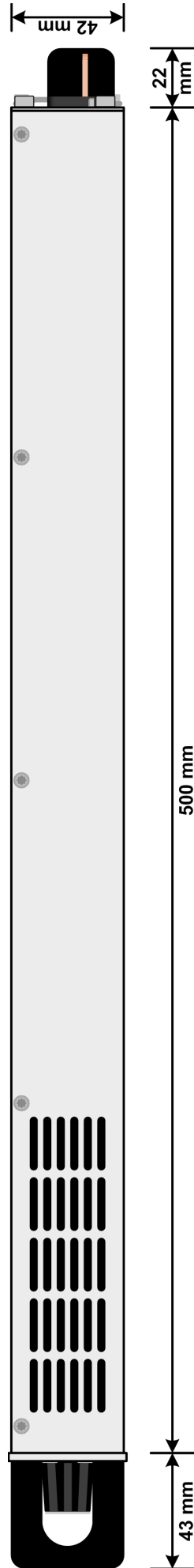

Figure 4 - Right hand side view without DC cover

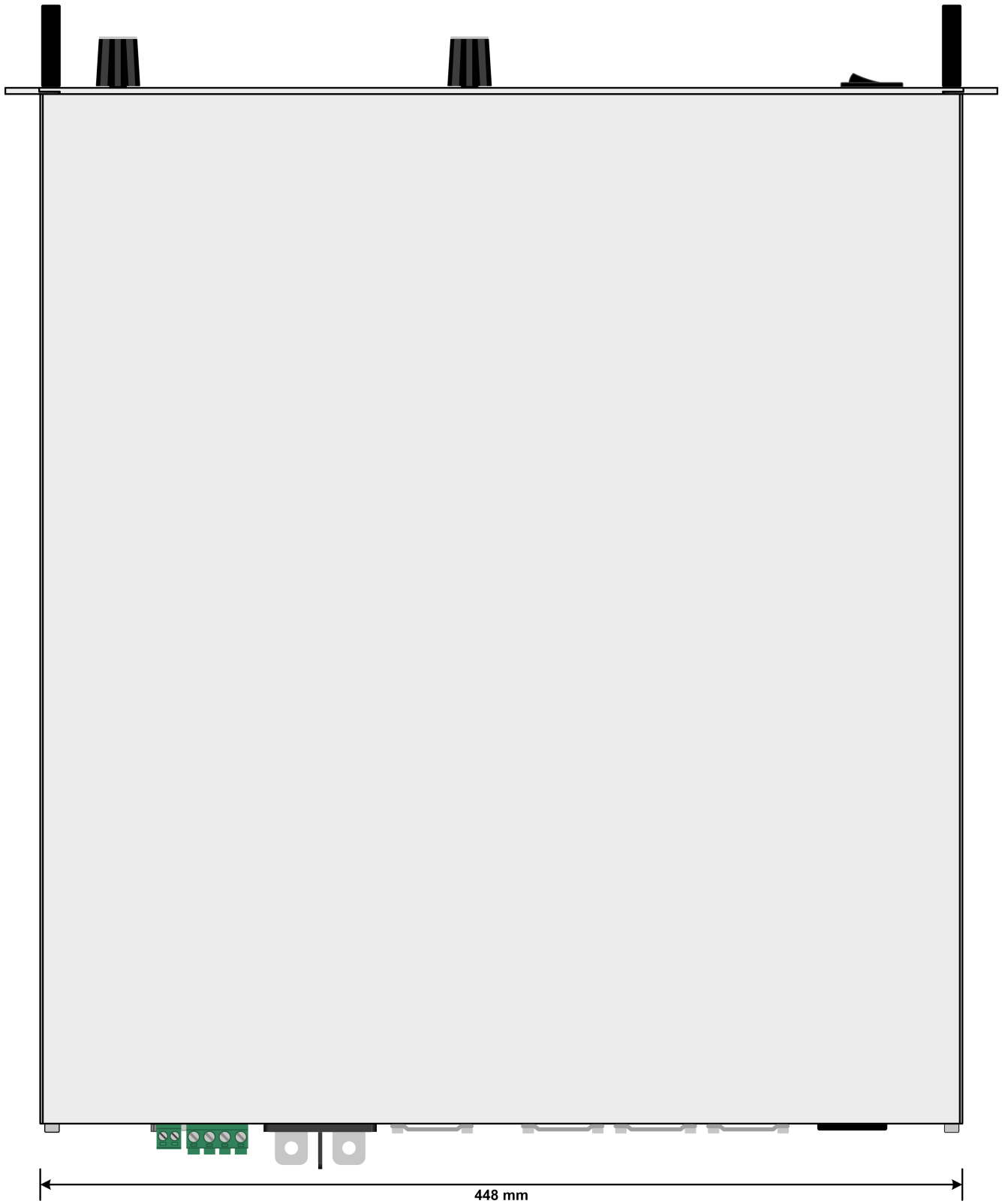

Figure 5 - Top view

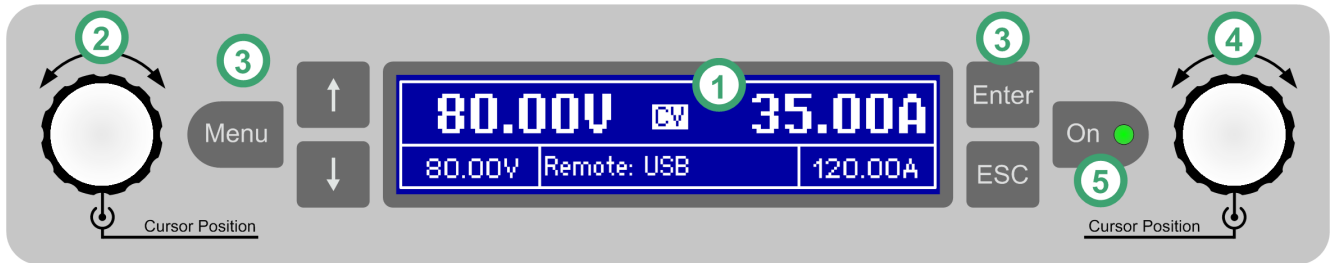







Figure 6 - Control Panel

Overview of the elements of the operating panel

For a detailed description see section “1.9.4. The control panel (HMI)”.

(1)	<p>Display</p> <p>Used for indication of set values, menus, conditions, actual values and status.</p>
(2)	<p>Left hand rotary knob, with pushbutton function</p> <p>Turn: adjusts various set values which are related to the DC output voltage. Push: selects the decimal position of a value to be changed (cursor)</p>
(3)	<p>Button bank</p> <p>Button  : Activates the setup menu for various device settings (see „3.4.3. Configuration in the setup menu“)</p> <p>Button  : Navigates through menus, submenus and parameters (direction: up / left) or changes view mode</p> <p>Button  : Navigates through menus, submenus and parameters (direction: down / right) or changes view mode</p> <p>Button  : Submits altered parameters or set values in submenus, as well enters submenus. Can also be used to acknowledge alarms.</p> <p>Button  : Cancels changes of parameters in the setup menu or leaves submenus</p>
(4)	<p>Right hand rotary knob, with pushbutton function</p> <p>Turn: adjusts various set values which are related to the DC output current, the DC output power. Also adjusts parameters in the setup menu. Push: selects the decimal position of a value to be changed (cursor)</p>
(5)	<p>On/Off Button for DC output </p> <p>Used to toggle the DC output between on and off, also used to acknowledge alarms. The LED indicates the state of the DC output, no matter if the device is manually controlled or remotely (LED on = output on).</p>

PS 9000 1U Series

1.9 Construction and function

1.9.1 General description

The electronic high performance power supplies of the PS 9000 1U series are especially suitable for test systems and industrial controls because of their compact construction in a 19" enclosure with 1 height unit (1U).

For remote control using a PC or PLC the devices are provided as standard with a USB-B slot and an Ethernet port on the backside as well as a galvanically-isolated analog interface. All interfaces are galvanically-isolated up to 1500 V DC.

In addition, the devices offer as standard the possibility for parallel connection in Share bus operation for constant current sharing. Operating in this way allows up to 10 units to be combined as a single system with a total power of up to 30 kW.

All models are controlled by microprocessors. These enable an exact and fast measurement and display of actual values.

1.9.2 Block diagram

The block diagram illustrates the main components inside the device and their relationships.

There are digital, microprocessor controlled components (KE, DR, BE), which can be target of firmware updates.

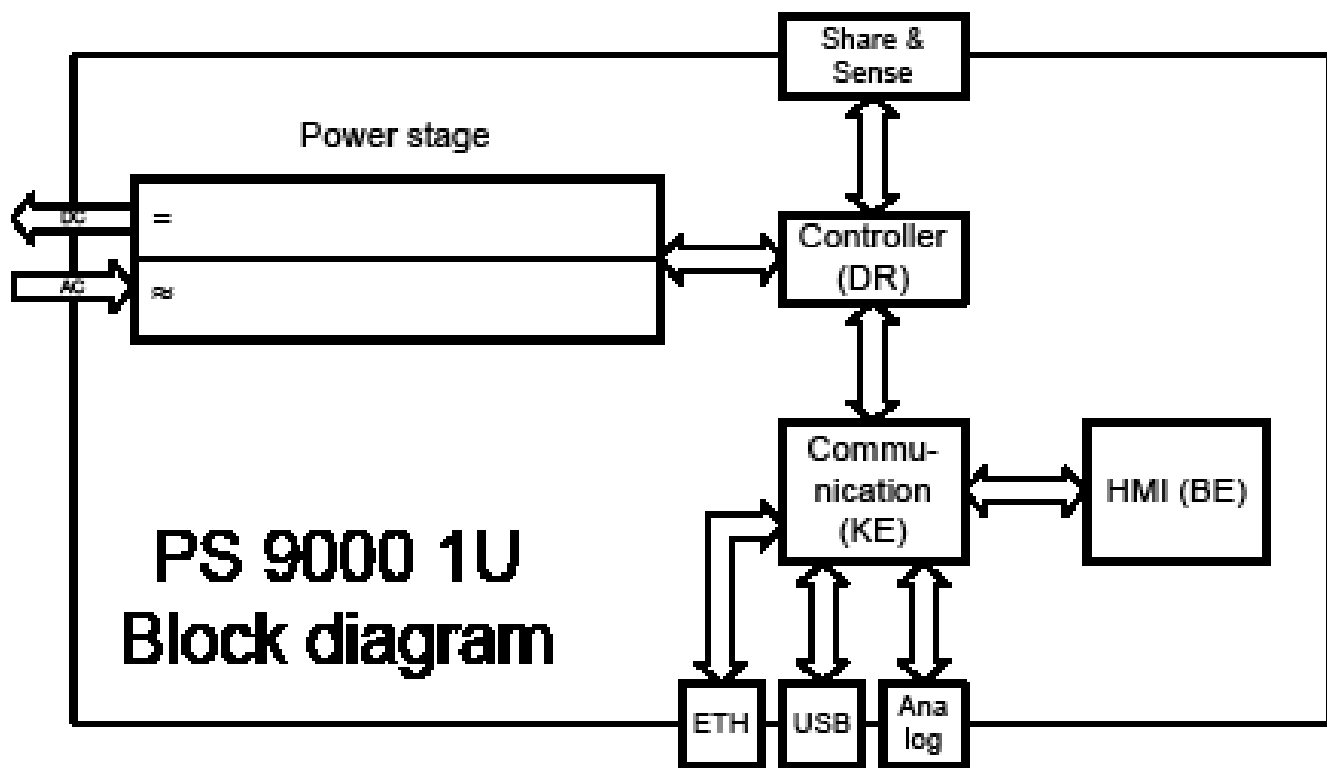

1.9.3 Scope of delivery

- 1 x Power supply device
- 1 x AC cord (IEC type plug, 250 V, 16 A)
- 1 x Printed operating guide
- 1 x Share Bus plug
- 1 x Remote sensing plug
- 1 x 1.8 m USB cable
- 1 x CD "Drivers & Tools"

1.9.4 The control panel (HMI)

The HMI (Human Machine Interface) consists of a display, two rotary knobs with pushbutton function and six pushbuttons.

1.9.4.1 Display

The graphic display is divided into a number of areas. In normal operation the left upper half is used to show actual values and the lower half is used to display status information and set values:

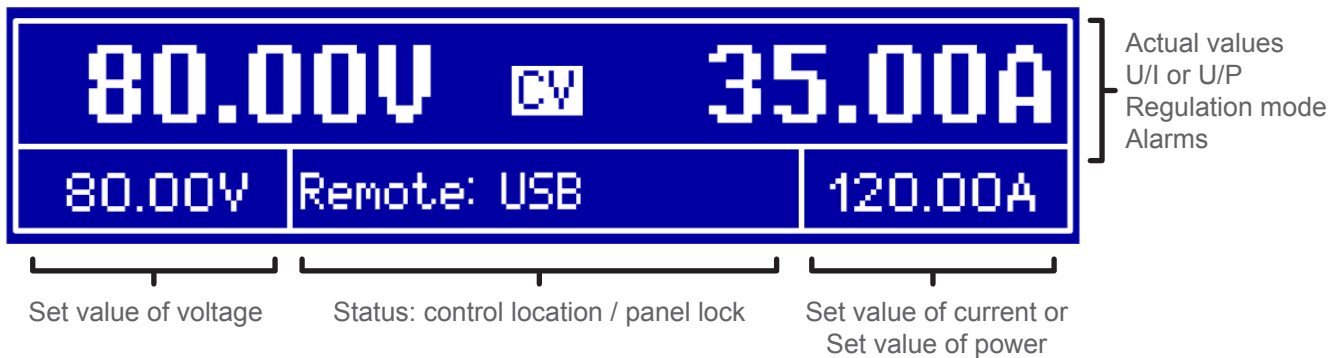

- **Actual values area (upper half)**

In normal operation the DC output values (large numbers) of voltage and current resp. of power are displayed, depending on the selected view mode. The display format of values is according to what's listed in 1.9.4.4.

Furthermore, the actual regulation mode **CV**, **CC** or **CP** (see "3.2. Operating modes") is displayed here, as well as alarms with abbreviations (**OT**, **OVP**, **OCP**, **PF**, **OPP**). For details refer to "3.3. Alarm conditions".

- **Set values area (lower half, left and right side)**

The set values of voltage and current (mode: U/I) resp. of voltage and power (mode: U/P) are displayed here and are adjustable with the left hand and right hand rotary knobs when operating the device manually. While doing so, the digit to adjust can be selected by pushing the corresponding rotary knob, in order to move the cursor. The left hand rotary knob is always assigned to the DC output voltage and related parameters like OVP or U-max, whereas the right hand rotary knobs is either assigned to the DC output current and related parameters or to the DC output power. In remote control condition, no matter if analog or digital, the set values given from remote are displayed here.

Logically, the values are increased by clockwise turning and decreased by counter-clockwise turning, unless they are somehow limited by a maximum value or an adjustment limit (see "3.4.4. Adjustment limits").

General display and settings ranges:

Display	Unit	Range	Description
Actual voltage	V	0-125% U_{Nom}	Actual values of DC output voltage
Set value voltage	V	0-102% U_{Nom}	Set value for limiting the DC output voltage
Actual current	A	0.1-125% I_{Nom}	Actual value of DC output current
Set value current	A	0-102% I_{Nom}	Set value for limiting the DC output current
Actual power	W	0-125% P_{Nom}	Actual value of output power, $P = U \cdot I$
Set value power	W	0-102% P_{Nom}	Set value for limiting DC output power
Adjustment limits	A, V, kW	0-102% Nominal val.	U-max, I-min etc., related to the physical units
Protection settings	A, V, kW	0-110% Nominal val.	OVP, OCP etc., related to the physical units

- **Status area (lower half, middle)**

This area shows the control location mode (see "3.5.2. Control locations") or another status (see table below). In case pushbutton **Menu** is activated while the output is on, the quick menu (see "3.4.7. The quick menu") will be displayed:



PS 9000 1U Series

This area furthermore displays various status texts:

Display	Description
Locked	The HMI is locked
Remote	The device is under remote control from...
Analog	...the built-in analog interface
USB	...the built-in USB port or a plug in interface module
Ethernet	...the built-in Ethernet/LAN port
Local	The device has been locked by the user explicitly against remote control

1.9.4.2 Rotary knobs



As long as the device is in manual operation, the two rotary knobs are used to adjust set values, as well as setting the parameters in the settings menu. For a detailed description of the individual functions see section “3.4 Manual operation” on page 31.

1.9.4.3 Pushbutton function of the rotary knobs

The rotary knobs also have a pushbutton function which is used in all menu options for value adjustment to move the cursor by rotation as shown:



1.9.4.4 Resolution of the displayed values

In the display, set values can be adjusted in fixed increments. The number of decimal places depends on the device model. The values have 4 or 5 digits, while actual and set values related to the same physical unit always have the same number of digits.

Adjustment resolution and number of digits of set values in the display:

Voltage, OVP, U-min, U-max			Current, OCP, I-min, I-max			Power, OPP, P-max		
Nominal	Digits	Min. increment	Nominal	Digits	Min. increment	Nominal	Digits	Min. increment
80 V	4	0.01 V	6 A	4	0.001 A	1500 W	4	1 W
200 V	5	0.01 V	10 A / 12 A	5	0.001 A	3000 W	4	1 W
360 V / 500 V	4	0.1 V	15 A / 20 A	5	0.001 A			
750 V	4	0.1 V	25 A	5	0.001 A			
			30 A / 50 A	4	0.01 A			
			100 A	5	0.01 A			



In manual operation every set value can be set in the increments given above. In this case the actual output values set by the device will lie within percentage tolerances as shown in the technical data sheets. These will influence the actual values.

1.9.5 Sense connector (remote sensing)

During constant voltage operation (CV) and in case the adjusted output voltage has to be held constant on the load and not on the power supply’s DC output, remote sensing can be used in order to compensate for the voltage drop on cables up to a certain limit. The maximum possible compensation is given in the technical data.

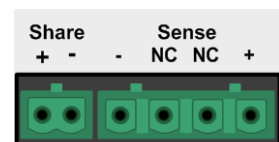

1.9.6 USB port

The USB-B port on the backside of the device is provided for communication with the device and for firmware updates. The included USB cable can be used to connect the device to a PC (USB 2.0, USB 3.0). The driver is delivered on the included CD or is available as a download and installs a virtual COM port. Details for remote control can be found in external documentation, a general programming guide, on the web site of Intepro Systems or on the included CD.

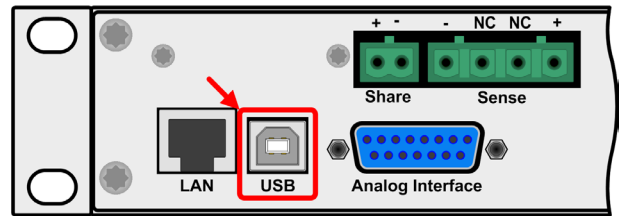

The device can be addressed through the USB port either using the international standard ModBus protocol or by SCPI language. The device recognizes the message protocol used automatically.

If remote control is in operation the USB port has no priority over either the analog interface or the Ethernet interface and can, therefore, only be used alternatively to these. However, monitoring is always available.

1.9.7 Ethernet port

The Ethernet port on the backside of the device (standard version of device only) is provided for communication with the device in terms of remote control or monitoring. The user has basically two options of access:

1. A website (HTTP, port 80) which is accessible in a standard browser under the IP or the host name given for the device. This website offers a configuration page for network parameters, as well as an input box for SCPI commands.

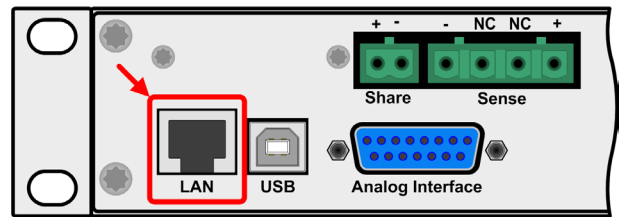

2. TCP/IP access through a freely selectable port (except 80 and other reserved ports). The standard port for this device is 5025, default IP is 192.168.0.2. Via TCP/IP and this port, communication to the device can be established in most of the common programming languages.

Using the Ethernet port, the device can either be controlled by commands from SCPI or ModBus protocol, while automatically detecting the type of message.

The network setup can be done manually or by DHCP. The transmission speed is set to “Auto negotiation” and means it can use 10MBit/s or 100MBit/s. 1GB/s is not supported. Duplex mode is always full duplex.

If remote control is in operation the Ethernet port has no priority over either the analog interface or the USB interface and can, therefore, only be used alternatively to these. However, monitoring is always available.

1.9.8 Analog interface

This 15-pole Sub-D socket on the backside of the device is provided for remote control of the device through analog signals or switching conditions.

If remote control is active this analog interface can only be used alternatively to the digital interface. However, monitoring is always available.

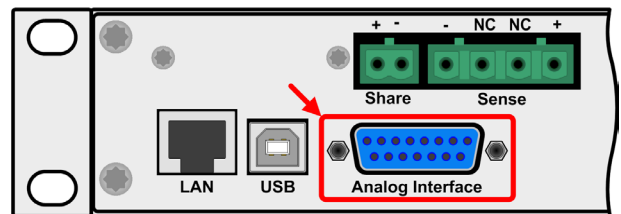

The input voltage range of the set values and the output voltage range of the monitor values, as well as reference voltage level can be switched in the settings menu of the device between 0-5 V and 0-10 V, in each case for 0-100%.

1.9.9 Sense connector (remote sensing)

During constant voltage operation (CV) and in case the adjusted output voltage has to be held constant on the load and not on the power supply’s DC output, remote sensing can be used to compensate for the voltage drop on cables up to a certain limit. The maximum possible compensation is given in the technical data.

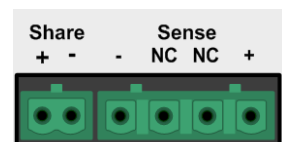

2. Installation & commissioning

2.1 Transport and storage

2.1.1 Transport



- The handles on the frontside of the device are **not** for carrying!
- Do not transport when switched on or connected!
- When relocating the equipment use of the original packing is recommended
- The device should always be carried and mounted horizontally
- Use suitable safety clothing, especially safety shoes, when carrying the equipment, as due to its weight a fall can have serious consequences.

2.1.2 Packaging

It is recommended to keep the complete transport packaging for the lifetime of the device for relocation or return to Intepro Systems for repair. Otherwise the packaging should be disposed of in an environmentally friendly way.

2.1.3 Storage

In case of long term storage of the equipment it is recommended to use the original packaging or similar. Storage must be in dry rooms, if possible in sealed packaging, to avoid internal corrosion from humidity.

2.2 Unpacking and visual check

After every transport, with or without packaging, or before commissioning, the equipment should be visually inspected for damage and completeness using the delivery note and/or parts list (see section “1.9.3. Scope of delivery”). An obviously damaged device (e.g. loose parts inside, damage outside) must under no circumstances be put in operation.

2.3 Installation

2.3.1 Safety procedures before installation and use



- When using a 19” rack, rails suitable for the width of the housing and the weight of the device should be used. (see “1.8.3. Specific technical data”)
- Before connecting to the mains ensure that the connection is as shown on the product label. Overvoltage on the AC supply can cause equipment damage.

2.3.2 Preparation

Mains connection for a PS 9000 1U series device is done via the included 2-meters long 3-pole mains cord. If a different AC wiring is required, make sure that the other cable has a minimum cross section of 1.5 mm² (AWG 12).

Dimensioning of the DC wiring to the load/consumer has to reflect the following:



- The cable cross section should always be specified for at least the maximum current of the device.
- Continuous operation at the approved limit generates heat which must be removed, as well as voltage loss which depends on cable length and heating. To compensate for these the cable cross section should be increased and the cable length reduced.

2.3.3 Installing the device



- Select the location for the device so that the connection to the load is as short as possible!
- Leave sufficient space behind the equipment, minimum 30cm, for ventilation!
- The device is not stackable!
- Do not put anything with a total weight of more than 1kg on top of the device!

A device in a 19" housing will usually be mounted on suitable rails and installed in 19" racks or cabinets. The depth of the device and its weight must be taken into account. The handles on the front are for sliding in and out of the cabinet. Slots on the front plate are provided for fixing the device (fixing screws not included).

Acceptable and unacceptable installation positions:

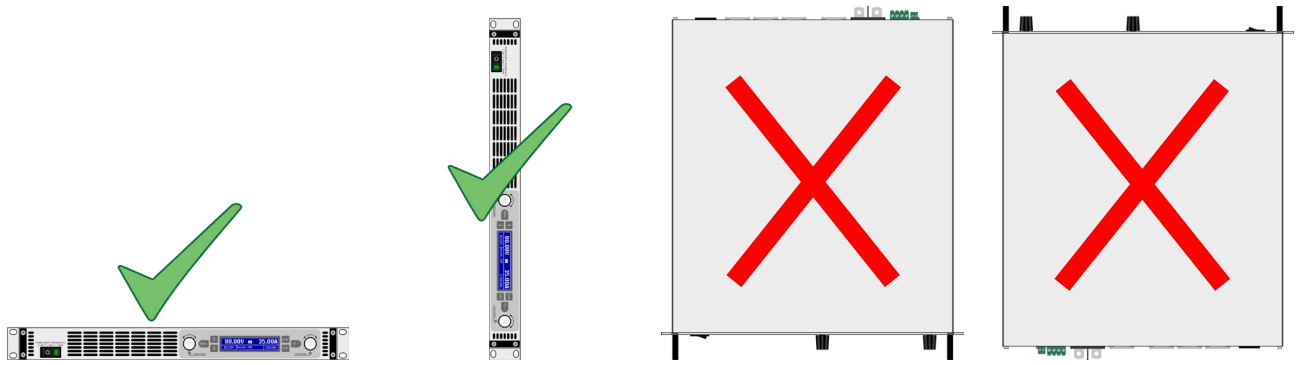

Standing surface

2.3.4 Connection to AC supply



- The device can be connected to any wall socket or multi-socket outlet, as long as the socket features a safety contact (PE) and is capable for 16 A.
- When connecting the device to a multi-socket outlet, along with other electric devices, it is important to consider the total power consumption of all devices on the outlet, so that the maximum current (power ÷ minimum voltage) does not exceed the definition for the wall socket, the multi-socket outlet and/or main distribution
- Before plugging-in the input plug ensure that the device is switched off by its mains switch!

The device is delivered with a 3 pole mains cord (L, N, PE). If the device is going to be connected to a standard 2-phase or 3-phase supply, the following leads and phases are required:

Nominal power	Phases	Supply type
1.5 kW / 3 kW	L1 or L2 or L3, N, PE	At least wall socket 16 A

The default input values of all models in this series are: 230 V, 16 A, 50 Hz. and internally fused with 16 A. The 16 A input definition is because of the AC input current depending on the higher intake at low AC voltage (for minimum input voltage see technical specs).

PS 9000 1U Series

2.3.5 Connection to DC loads



- For a device with a high nominal current and having a thick and heavy DC connection cable it is necessary to consider the weight of the cable and the strain imposed on the DC connection. Especially when mounted in a 19" cabinet or similar, where the cable hangs on the DC output, a strain reliever should be used.
- Connection to and operation with transformerless DC-AC inverters (for example solar inverters) is restricted, because the inverter can shift the potential of negative output (DC-) against PE (ground), which is generally limited to max. 400 V DC.

The DC load output is on the rearside of the device and is **not** protected by a fuse. The cross section of the connection cable is determined by the current consumption, cable length and ambient temperature.

For cables **up to 1.5 m** and average ambient temperature up to 50°C, we recommend:

up to 10 A :	0,75 mm ² (AWG18)	up to 15 A :	1,5 mm ² (AWG14)
up to 30 A :	4 mm ² (AWG10)	up to 40 A :	6 mm ² (AWG8)
up to 60 A :	16 mm ² (AWG4)	up to 100 A :	25 mm ² (AWG2)

per lead (multi-conductor, insulated, openly suspended). Single cables of, for example, 70 mm² may be replaced by e.g. 2x35 mm² etc. If the cables are long then the cross section must be increased to avoid voltage loss and overheating.

2.3.5.1 DC terminal

The table below shows an overview of the various DC terminals. It is recommended that connection of load cables always utilizes flexible cables with ring lugs.



M6 bolt on a nickel plated copper bar

Recommendation: Ring lugs with a 6 mm hole

2.3.5.2 Cable lead and plastic cover

A plastic cover for contact protection is included for the DC terminal. It should always be installed.

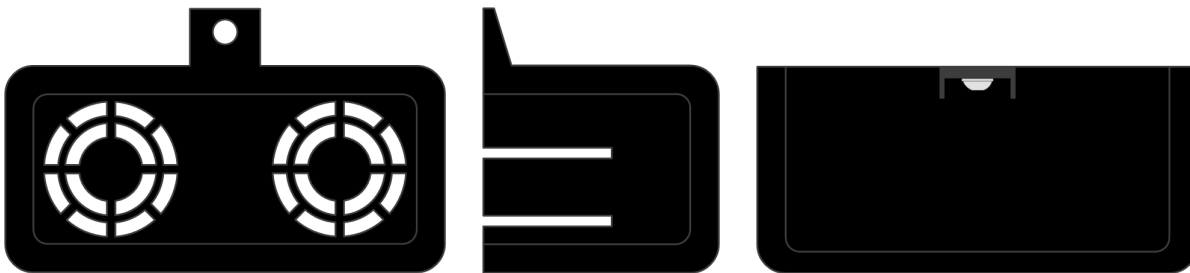

The connection angle and the required bending radius for the DC cable must be taken into account when planning the depth of the complete device, especially when installing in a 19" cabinet or similar. In case, the plastic DC cover is going to be used, only horizontal lead of the cables is possible.

2.3.6 Grounding of the DC output

Individually-operated devices can always be grounded from the DC minus pole, i.e. can be directly connected to PE. The DC-plus pole, however, if it is to be grounded, may only be so for output voltages up to 400 V, unless stated otherwise in the technical specifications.

For this reason, for all models which can provide an output voltage of more than 400 V, grounding of the DC-plus pole is not recommended, because it will shift the potential of the DC minus pole in negative direction, up to the maximum output voltage. If the output voltage is not adjusted higher than 400 V, grounding the DC plus pole is allowed with restrictions.



- Grounding of the DC-plus pole for any model with >400 V nominal voltage only at one's own risk! Risk of damaging the device! Risk of voiding warranty!
- Digital and analog interfaces are galvanically isolated from the DC output and should never be grounded, but under no circumstances if any of the DC output poles is grounded too, because this will cancel the galvanic isolation
- If grounding one of the DC output poles check if any pole of the load is already grounded. This could lead to a short circuit!

2.3.7 Connection of remote sensing

In order to compensate, to a certain degree, the voltage loss in a DC cable, the device provides the possibility to connect the remote sensing input "Sense" to the load. The device recognizes the remote sensing mode automatically and regulates the output voltage (only in CV operation) at the load rather than at its own DC output.

In the technical specifications (see section "1.8.3. Specific technical data") the level of maximum possible compensation is given. If that is insufficient, the cable cross section must be increased.



Both pins „NC“ of the Sense connector must not be wired!



- The cross section of the sense cables is noncritical. However, it should be increased with increasing cable length. Recommendation: for cables up to 5 m use at least 0.5 mm²
- Sense cables should be twisted and laid close to the DC cables to dampen oscillation. If necessary, an additional capacitor should be installed at the load/consumer to eliminate oscillation
- The sense cables must be connected + to + and - to - at the load, otherwise both systems may be damaged

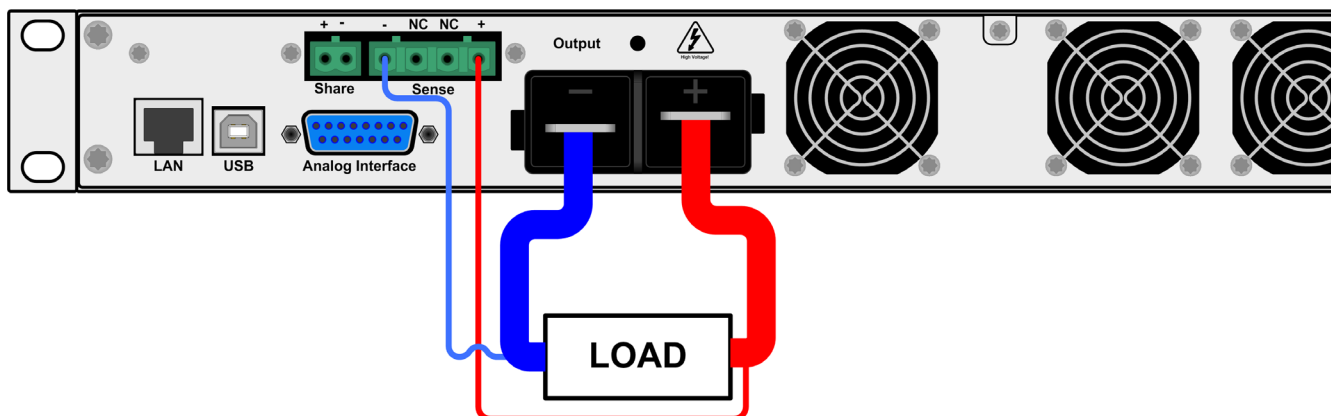

Figure 7 - Example for remote sensing wiring

2.3.8 Connecting the "Share" bus

The "Share" connector on the backside is intended to balance the current of multiple units in parallel operation, especially when using the integrated function generator of the master unit. For further information about this mode of operation can be found in section "3.9.1. Parallel operation in Share Bus mode".

For the connection of the share bus the following must be considered:



- Connection is only permitted between compatible devices (see "1.9.5. Share Bus-Connection" for details) and between a maximum of 10 units
- The Share bus is referenced to DC minus output and thus affected by potential shifts. The potential of the DC minus has to be considered when connecting the Sharebus to other devices.

PS 9000 1U Series

2.3.9 Connecting the analog interface

The 15-pole connector (Type: Sub-D, D-Sub) on the rearside is an analog interface. To connect this to a controlling hardware (PC, electronic circuit), a standard plug is necessary (not included in the scope of delivery). It is generally advisable to switch the device completely off before connecting or disconnecting this connector, but at least the DC output.



The analog interface is galvanically isolated from the device internally. Therefore do not connect any ground of the analog interface (AGND) to the DC minus output as this will cancel the galvanic isolation.

2.3.10 Connecting the USB port

To remotely control the device through this port, connect the device with a PC using the included USB cable and switch the device on.

2.3.10.1 Driver installation (Windows)

On the initial connection with a PC the operating system will identify the device as new hardware and will install the driver. The driver is a Communications Device Class (CDC) type and is usually integrated in current operating systems such as Windows 7 or 10. But it is strongly recommended to use and install the included driver installer (on the USB stick) to gain maximum compatibility of the device to our software.

2.3.10.2 Driver installation (Linux, MacOS)

We cannot provide drivers or installation instructions for these operating systems. A suitable driver may be found by searching the Internet.

2.3.10.3 Alternative drivers

If the CDC drivers described above are not available on your system, or for some reason do not function correctly, commercial suppliers can help. Search the Internet for suppliers using the keywords “cdc driver windows“ or “cdc driver linux“ or “cdc driver macos“.

2.3.11 Initial commission

For the first start-up after purchasing and installing the device, the following procedures must be executed:

- Confirm that the connection cables to be used are of a satisfactory cross section
- Check that the default settings for set values, safety and monitoring functions and communication are suitable for your application and change them where necessary, as described in the manual
- If remote control through a PC is active, read the additional documentation for interfaces and software
- If remote control through the analog interface is active, read the section in this manual concerning analog interfaces and, where needed, other appropriate documentation especially concerning the use of such interfaces

2.3.12 Initial network setup

The device is delivered with default network parameters (see “3.4.3.6. Menu “Communication”). The Ethernet/LAN port is immediately ready for use after the initial commission. Default parameters are:

IP: 192.168.0.2

Subnet mask: 255.255.255.0

Gateway: 192.168.0.1

Port: 5025

DHCP: off

For wiring, i.e. the hardware connection to a network, seek support from your IT manager or any similar responsible person. Network cable of common type (CAT5 or better) can be used.

In order to set up the network parameter to your needs, you have three options: the setup menu or the device’s website or the software “EA Power Control”, which is available since April 2015 as a download or included with your device. For the configuration in the setup menu please refer to “3.4.3.6. Menu “Communication””.

For the configuration through the device’s website or EA Power Control, you need the device to be connected to a network or directly to a PC which can access the default IP 192.168.0.2.

► How to do the network setup on the device website

1. If the device display is in any kind of menu, leave menu to main display.
2. Open the device website in a browser by entering the default IP (<http://192.168.0.2>) or the default host name (<http://Client>, only possible if there is a running DNS in the network) into the URL box.
3. After the website has been completely loaded, check the status field item “**Access**” to show the status “**free**”. In case it shows different, the device is either already in remote control (**rem**) or blocked from remote control (**local**). If it shows “**local**”, first remove the block. Refer to section “3.5.2. Control locations” to do that.
4. If it says “**rem**” in the “**Access**” item, skip to step 4. Else enter command **sys:lock on** (attention! space before **on**) into the **SCPI command** box and send with return key. Check if item “**Access**” in status field changes to “**rem-eth**” (means: remote Ethernet).
5. Switch to page **CONFIGURATION** (upper left corner) and set up the network parameters as well as the port here resp. activate DHCP and submit the change with **SUBMIT** button.
6. Wait a few seconds before testing the new IP by entering it in the browser’s URL box. Opening the website again by using the host name is only possible after the device has restarted, because only then is the new IP reported to the DNS.

2.3.13 Commission after a firmware update or a long period of non-use

After a firmware update, return of the equipment following repair or a location or configuration change, similar measures should be taken to those of initial start up. Refer to “2.3.11. Initial commission”.

Only after successful checking of the device as listed may it be operated as usual.

3. Operation and application

3.1 Important notes

3.1.1 Personal safety



- To guarantee safety when using the device, it is essential that only persons who are fully acquainted and trained in the required safety measures required when working with dangerous electrical voltages operate the device
- For models which can generate a voltage that is dangerous by contact, or is connected to such, the included DC terminal cover, or an equivalent, must always be used
- Whenever the load and DC output are being re-configured, the device should be disconnected from the mains, not only the DC output switched off!

3.1.2 General



- Operation of a power supply without any load or a very small load (<0.5% of INom) is not considered as a normal operation mode
- Technical specifications cannot be guaranteed when running a power supply without a load
- It is always recommended to run a power supply with at least 10% voltage and current load

3.2 Operating modes

A power supply is internally controlled by different control or regulation circuits, which shall bring voltage, current and power to the adjusted values and hold them constant, if possible. These circuits follow typical laws of control systems engineering, resulting in different operating modes. Every operating mode has its own characteristics which are briefly explained below.

3.2.1 Voltage regulation / Constant voltage

Voltage regulation is also called constant voltage operation (CV).

The DC output voltage of a power supply is held constant on the adjusted value, unless the output current or the output power according to $P = U_{OUT} * I_{OUT}$ reaches the adjusted current or power limit. In both cases the device will automatically change to constant current or constant power operation, whichever occurs first. Then the output voltage cannot be held constant anymore and will sink to a value resulting from Ohm's law.

While the DC output is switched on and constant voltage mode is active, then the condition "CV mode active" will be indicated on the display by the abbreviation CV and this message will be passed as a signal to the analog interface, and stored as a status which can also be read as a status message through the digital interface.

3.2.2 Current regulation / constant current / current limiting

Current regulation is also known as current limitation or constant current mode (CC).

The DC output current is held constant by the power supply, once the output current to the load reaches the adjusted limit. Then the power supply automatically switches. The current flowing from the power supply is determined by the output voltage and the load's true resistance. As long as the output current is lower than the adjusted current limit, the device will be either in constant voltage or constant power mode. If, however, the power consumption reaches the set maximum power value, the device will switch automatically to power limiting and sets the output current according to $I_{MAX} = P_{SET} / U_{IN}$, even if the maximum current value is higher. The current set value, as determined by the user, is always an upper limit only.

While the DC output is switched on and constant current mode is active, then the condition "CC mode active" will be indicated on the display by the abbreviation CC and this message will be passed as a signal to the analog interface, as well stored as status which can also be read as a status message via digital interface.

3.2.3 Power regulation / constant power / power limiting

Power regulation, also known as power limiting or constant power (CP), keeps the DC output power of a power supply constant if the current flowing to the load in relation to the output voltage and the resistance of the load reaches the adjusted power value according to $P = U \cdot I$ resp. $P = U^2 / R$. The power limitation then regulates the output current according to $I = \sqrt{P / R}$, where R is the load's resistance.

Power limiting operates according to the auto-range principle such that at lower output voltages higher current flows and vice versa in order to maintain constant power within the range P_N (see diagram to the right)

Constant power operation primarily impacts the output current. The adjusted maximum output current cannot be achieved if the maximum power value limits the output current according to $I = P / U$. The adjustable set value of current, as indicated in the display, is always a upper limit.

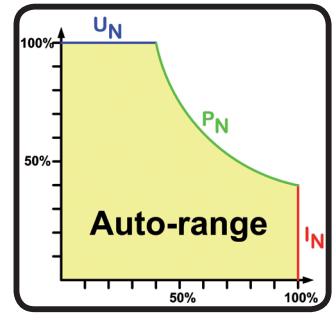

While the DC output is switched on and constant power mode is active, then the condition “CP mode active” will be shown on the display by the abbreviation **CP** and can also be read as a status message through the digital interface.

3.2.3.1 Power derating

The power supplies of series PS 9000 1U offer an extended AC supply voltage range, but are dedicated for the use at typical $230 V_{AC}$, $\pm 10\%$. Below a certain supply voltage, all models will automatically start to derate, i.e. reduce the maximum available output power. The derating happens on the AC input side and thus the device will not indicate the derating condition as “CP” (constant power resp. power limitation).

Depending on the nominal power of the particular model, the derating acts at different supply voltages:

- 3 kW models
 - Below approx. $207 V_{AC}$: Derating to max. 2500 W output power
 - Below approx. $180 V_{AC}$: Shutdown of the DC output
- 1.5 kW models
 - Below approx. $150 V_{AC}$: Derating to max. 1000 W output power
 - Below approx. $90 V_{AC}$: Shutdown of the DC output

PS 9000 1U Series

3.3 Alarm conditions



This section only gives an overview about device alarms. What to do in case your device indicates an alarm condition is described in section “3.6. Alarms and monitoring”.

As a basic principle, all alarm conditions are signalled optically (Text + message in the display), acoustically (if activated) and as a readable status via the digital interface. With any alarm occurring, the DC output of the device is switched off. In addition, the alarms OT and OVP are reported as signals on the analogue interface.

3.3.1 Power Fail

Power Fail (PF) indicates an alarm condition which may have various causes:

- AC input voltage too high (mains overvoltage) or too low (mains undervoltage, mains failure)
- Defect in the input circuit (PFC)



Switching off the device by the mains switch cannot be distinguished from a mains blackout and thus the device will signal a PF alarm every time the device is switched off. This can be ignored.

3.3.2 Overtemperature

An overtemperature alarm (OT) can occur if

- an excess temperature inside the device causes the DC output to switch off.

Internal overtemperature and subsequent temporary shutdown is usually caused by insufficient cooling (excess ambient temperature, fans and air inlets polluted). The fans will still cool down the unit until it can automatically switch on again to continue operation.

3.3.3 Overvoltage

An overvoltage alarm (OVP) will switch off the DC output and can occur if

- the power supply itself, as a voltage source, generates an output voltage higher than set for the overvoltage alarm limit (OVP, 0...110% U_{Nom}) or the connected load somehow returns voltage higher than set for the overvoltage alarm limit
- the OV threshold has been adjusted too close above the output voltage. If the device is in CC mode and if it then experiences a negative load step, it will make the voltage rise quickly, resulting in a voltage overshoot for a short moment which can already trigger the OVP

This function serves to warn the user of the power supply acoustically or optically that the device probably has generated an excessive voltage which could damage the connected load application.



The device is not fitted with protection from external overvoltage. Overvoltage can damage parts inside!

3.3.4 Overcurrent

An overcurrent alarm (OCP) will switch off the DC output and can occur if

- the output current in the DC output reaches the adjusted OCP limit.

This function serves to protect the connected load application so that this is not overloaded and possibly damaged because of an excessive current.

3.3.5 Overpower

An overpower alarm (OPP) will switch off the DC output and can occur if:

- the product of the output voltage and output current in the DC output reaches the adjusted OPP limit.

This function serves to protect the connected load application so that this is not overloaded and possibly damaged due to an excessive power consumption.

3.4 Manual operation

3.4.1 Switching on the device

The device should always be switched on using the rotary switch on the front of the device. Alternatively this can take place using an external cutout (contactor, circuit breaker) of suitable current capacity.

After switching on, the display will show the manufacturers logo for a few seconds, plus some information like device model, firmware version(s), serial number and item number and will then be ready for use. In setup (see section "3.4.3. Configuration in the setup menu") in the second level menu "**General**" is an option "**DC output after power ON**" in which the user can determine the condition of the DC output after power-up. Factory setting here is "**OFF**", meaning that the DC output on power-up is always switched off. Selection "**Restore**" means that the last condition of the DC output will be restored, either on or off. All set values are always saved and restored.

3.4.2 Switching off the device

On switch-off the last output condition and the most recent set values are saved. Furthermore, a "PF" alarm (power failure) will be reported, but can be ignored.

The DC output is immediately switched off and after a short while fans will shut down and after another few seconds the device will be completely powered off.

3.4.3 Configuration in the setup menu

The setup menu serves to configure all operating parameters which are not constantly required. It can be entered by pushing , but only while the DC output is switched off. See figures below.

If the DC output is switched on the settings menu will not show, however the quick menu will show some status information.

Menu navigation is done with the pushbuttons ,  and . Parameters (values, settings) are set using the rotary knobs.

The assignments of the rotary knobs, if multiple values can be set in a particular menu, is always the same: parameters on the left-hand side -> left-hand knob, parameters on the right-hand side -> right-hand knob

0.00V		0.00A	
80.00V			120.00A



Settings	Profiles	Communication
Overview	About HW,SW	HMI Setup

The menu structure is shown schematically on the next page. Some setting parameters are self-explanatory, others are not. The latter will be explained on the pages following.

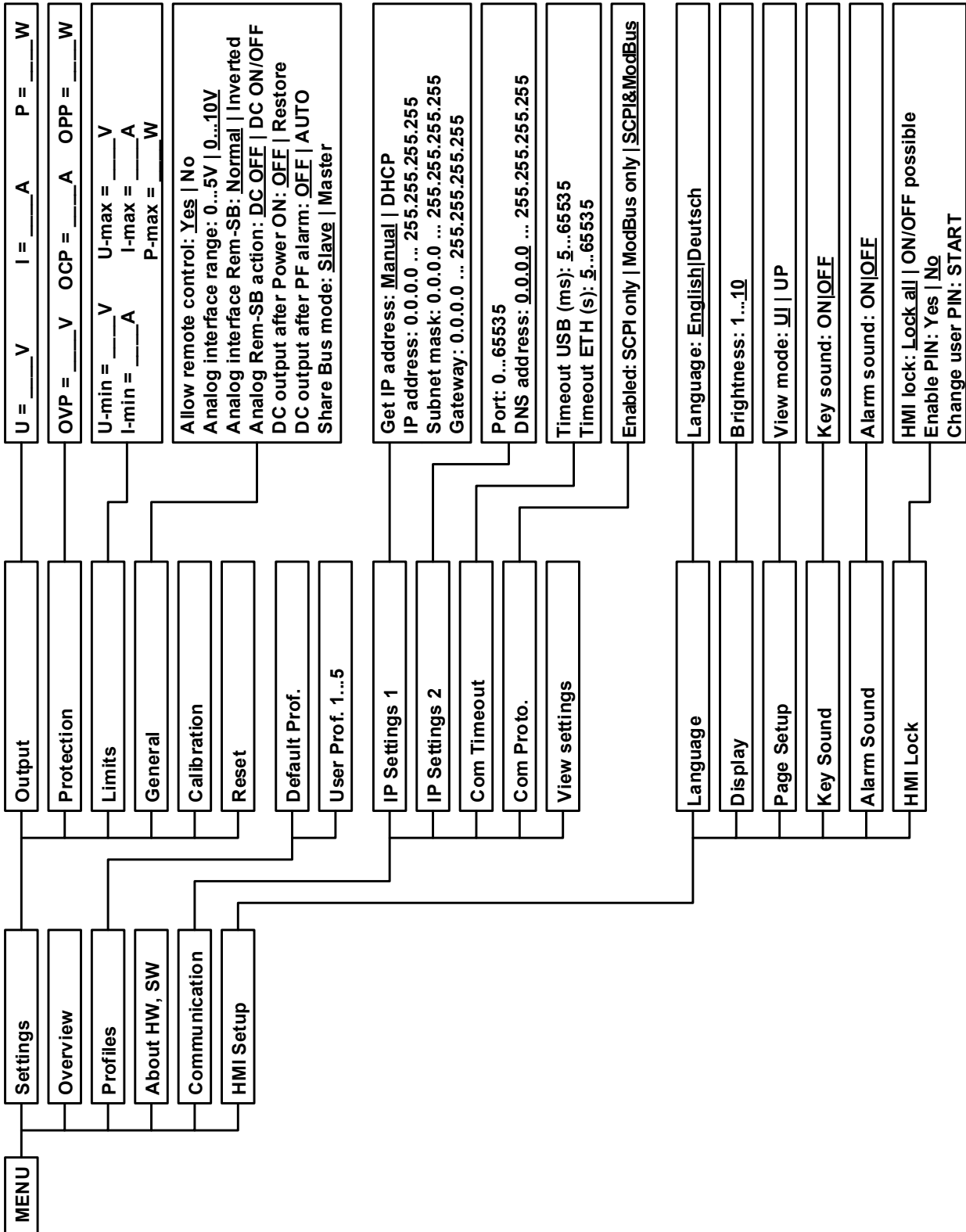

Underlined parameters show the default value after delivery or reset.

3.4.3.1 Menu “General Settings”

Element	P.	Description
Allow remote control	1	Selection “NO” means that the device cannot be remotely controlled over any of the digital or analog interfaces. If remote control is not allowed, the status will be shown as “Local” in the status area on the main display. Also see section 1.9.4.1
Analog interface range	2	Selects the voltage range for the analog set input values, actual output values and reference voltage output of the analog interface on the rear. <ul style="list-style-type: none"> • 0...5 V = Range is 0...100% set /actual values, reference voltage 5 V • 0...10 V = Range is 0...100% set /actual values, reference voltage 10 V See also section “3.5.4. Remote control via the analog interface (AI)”
Analog interface Rem-SB	3	Determines with “normal” (default), that the function and levels of input Rem-SB are as described in “3.5.4.3. Analog interface specification”. With selection “inverted”, the described function is logically inverted. Also see example a) in “3.5.4.6. Application examples”.
Analog Rem-SB action	4	Since Firmware 2.03, the input REM-SB of the analog interface can be used to control the DC output of the device even without remote control via analog interface being activated. This setting determines the type of action: <ul style="list-style-type: none"> • DC OFF = Toggling the pin only switches the DC output off • DC ON/OFF = If the DC output has been switched on before, toggling the pin can switch the output off and on again
DC output after power ON	5	Determines the condition of the DC output after power-up. <ul style="list-style-type: none"> • OFF = DC output is always off after switching on the device. • Restore = DC output condition will be restored to the condition prior to switch off.
DC output after PF alarm	6	Determines how the DC output shall react after a power fail (PF) alarm has occurred: <ul style="list-style-type: none"> • OFF = DC output will be switched off and remain until user action • AUTO = DC output will switch on again after the PF alarm cause is gone and if it was switched on before the alarm occurred
Share Bus mode	7	Default setting: Slave For parallel operation of multiple units, where using the Share bus connection is recommended. In parallel operation, any unit could be master.

3.4.3.2 Menu “Calibrate Device”

From within this menu, a calibration and readjustment procedure for output voltage and current, separate procedures for set value and actual value, can be started. For further details refer to „4.4. Calibration (readjustment)“.

Element	Description
Voltage	Starts the semi-automatic calibration procedure for output voltage U
Sense volt.	Starts the semi-automatic calibration procedure for remote sensing input “Sense”
Current	Starts the semi-automatic calibration procedure for output current I
Cal. date	Here you can enter the date of the most recent calibration (year, month, day)
Save & exit	This menu item saves and leaves the setup menu to main display

3.4.3.3 Menu “Reset Device”

Entering this menu item will prompt for acknowledgement to reset the device completely to default settings and set values. Selecting “No” will cancel the reset procedure, while selecting “Yes”, submitted by  button, will instantly reset the device.

3.4.3.4 Menu “Profiles”

See “3.8 Loading and saving a user profile” on page 45.

3.4.3.5 Menus “Overview” and “About HW, SW...”

This menu pages display an overview of the set values (U, I, P), related protection settings (OVP, OCP, OPP), limits settings and an alarm history (counter) of alarms that might have occurred since the last time the unit was switched on. Furthermore, you can find information about the device (model, serial number, firmware versions etc.).

PS 9000 1U Series

3.4.3.6 Menu “Communication”

Settings for the Ethernet port (on rear side of device) are made here. The USB port there doesn't require any settings.

When delivered or after a complete reset, the Ethernet port has the following **default settings** assigned:

- DHCP: off
- IP: 192.168.0.2
- Subnet mask: 255.255.255.0
- Gateway: 192.168.0.1
- Port: 5025
- DNS: 0.0.0.0
- Host name: Client
- Domain: Workgroup

Those settings can be changed anytime at will, in the setup menu or via the device website, which you can open from the current IP or host name (also see 2.3.12).

Submenu “IP Settings 1”

Element	Description
Get IP address	Manual (default): uses the default (after delivery or reset) or the last set network parameters. Those parameters are not overwritten by selection “ DHCP ” and remain when switching back from “ DHCP ” to “ Manual ” DHCP : after switching to DHCP and submitting the change with button  , the device will instantly try to get network parameters (IP, subnet mask, gateway, DNS) assigned from a DHCP server. If the attempt fails, the device will use the settings from “ Manual ” again. In this case, the overview in screen “ View settings ” will indicate the DHCP status as “ DHCP (failed) ”, otherwise as “ DHCP(active) ”
IP address	Only available with setting “ Get IP address = Manual ”. Default value: 192.168.0.2 Permanent manual setting of the device's IP address in standard IP format
Subnet mask	Only available with setting “ Get IP address = Manual ”. Default value: 255.255.255.0 Permanent manual setting of the subnet mask in standard IP format
Gateway	Only available with setting “ Get IP address = Manual ”. Default value: 192.168.0.1 Permanent manual setting of the gateway address in standard IP format

Submenu “IP Settings 2”

Element	Description
Port	Default value: 5025 Adjust the socket port here, which belongs to the IP address and serves for TCP/P access when controlling the device remotely via Ethernet
DNS address	Default value: 0.0.0.0 Permanent manual setting of the network address of a domain name server (short: DNS) which has to be present in order to translate the host name to the device's IP, so the device could alternatively access by the host name

Submenu “Com Proto.” (communication protocols)

Element	Description
Enabled	Default value: SCPI&ModBus Enables or disables SCPI or ModBus communication protocols for the device. The change is immediately effective after submitting it with ENTER button. Only one protocol can be disabled.

Submenu “Com Timeout” (communication timeout)

Element	Description
Timeout USB (ms)	Default value: 5 Communication timeout in milliseconds. Defines the max. time between two subsequent bytes or blocks of a transferred message. For more information about the timeout refer to the external programming documentation “Programming ModBus & SCPI”.
Timeout ETH (s)	Default value: 5 Adjustable time, after which the device will automatically disconnect the socket connection, if there was no communication during that period

3.4.3.7 Menu “HMI Setup”

These settings refer exclusively to the control panel (HMI) and the display. The table lists all available settings for the HMI, no matter in which submenu they can be found.

Element	Description
Language	Selection of the display language between “Deutsch” and “English”
Brightness	The brightness, i.e. background illumination of the display can be adjusted here. Range is 1...10, default is 10.
View mode	The display mode of actual and set values can be switched here. Refer to “3.4.5. Display modes for actual and set values” for details
Key Sound	Activates or deactivates sounds when pushing a button on the HMI. It can usefully signal that the action has been accepted.
Alarm Sound	Activates or deactivates the additional acoustic signal of an alarm. See also “3.6. Alarms and monitoring”.
HMI Lock	Activates the HMI lock. See “3.7. Control panel (HMI) lock” for details

3.4.4 Adjustment limits

By default, all set values (U, I, P) are freely adjustable from 0 to 100%.

This may be obstructive in some cases, especially for protection of applications against overcurrent. Therefore upper and lower limits for current and voltage can be set which limit the range of the adjustable set values. For power only an upper value limit can be set.

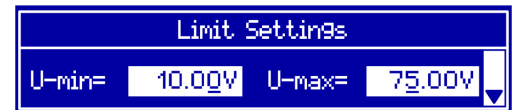







These limits apply to every kind setting a value. That also includes remote control via analog or digital interface. In remote control, the global range of 0...100% (digital) resp. 0...5 V / 0...10 V remains, only narrowed by the limits defined here.

An example: you would define the limits for a model with 80 V, 120 A and 3 kW as depicted in the screen above, with U-min = 10V and U-max = 75. In analog remote control, the active control voltage range for mode 0...10 V results as 1.25 V...9.375 V. As soon as the device is switched to analog remote control, it would put out minimum 10V, even there is nothing connected to voltage control input VSEL.

Beyond those limits, values given by digital commands are not accepted and will return an error (when using SCPI). Values given from analog control voltages are ignored (clipping).

► How to configure the adjustment limits

1. Switch off the DC output and push button  to call the setup menu.
2. Push button  to call submenu “Settings”. In the submenu navigate to “Limits” and push  again.
3. In the screen you can now adjust the settings I-min, I-max, U-min, U-max and P-max with the rotary knobs. Switching between values for current and power is done with the arrow buttons  and .
4. Accept the settings with  or discard them with .



The adjustment limits are coupled to the set values. The upper limit (-max) may not be set lower than the corresponding set value. Example: If you wish to set the limit for the current set value I-max to 90 A while the currently adjusted current set value is 100 A, then the set value first would have to be reduced to 90 A or less. The same applies vice versa when adjusting I-min.

PS 9000 1U Series



3.4.5 Display modes for actual and set values

The display of a PS 9000 1U device shows the actual output voltage and the related set value in the left half of the display and the actual output current and related set value in the right half. To have the power set value in direct access, the display mode can be switched.

Mode UI





Only voltage (U) and current (I) are displayed. This is the default mode.

The set value of power is then only accessible in the setup menu or when switching to a different view mode with the arrow buttons  or .





Mode UP





Alternatively to the actual and set values of current (I) and voltage (U) the actual and set values of power (P) are displayed.

The set value of current is then only accessible in the setup menu or when switching to a different view mode with the arrow buttons  or .

► How to change the display mode in the menu

1. Switch off the DC output and push button  to call the setup menu.
2. In the menu navigate to “HMI Setup” and push . Then in the submenu navigate to “Page Setup” and push  again.
3. Select the desired display mode (see above) with the right-hand rotary knob.
4. Accept the settings with  or discard them with .

► How to change the display mode directly

1. During normal display (as shown in the figures above), push any of the arrow buttons   to switch between the view modes.

Depending on your setting, the main display will change after leaving the setup menu and the right-hand rotary knob is then either assigned to set value of current or power

3.4.6 Manual adjustment of set values

Adjusting set values of voltage, current and power is a key feature of a power supply and hence the two rotary knobs on the front of the device are usually assigned to two of the three values, in manual operation. Default assignment is voltage and current.

During manual operation, these set values can only be adjusted with the **rotary knobs**.





Adjusting a value is immediately committed, no matter if the output is switched on or off.



When adjusting the set values, upper or lower limits may come into effect. See section “3.4.4. Adjustment limits”. Once a limit is reached, the display will show a note like “Limit: U-max” etc. for ~2 seconds.

► How to adjust values U, I or P with the rotary knobs

1. First check whether the value to be changed is assigned to one of the rotary knobs already. The assignment can be changed by selecting a different view mode. See „3.4.5. Display modes for actual and set values“.
2. With mode **UI** selected and as long as the main display is active, turn the left-hand knob to adjust output voltage and the right-hand knob to adjust the output current. In mode **UP**, turn the right-hand knob to adjust the output power, as long as the power set value with unit W (Watts) is displayed. The arrow buttons   can be used to toggle between current and power set value.
3. Any set values can be adjusted with the adjustment limits. For switching the digit to adjust, push the rotary knob that you are currently using to adjust the value. Every push moves the cursor under the digit in clock-wise order:





3.4.7 The quick menu

The quick menu is an alternative menu for quick access to offline features while the DC output is online.

It is accessible with the  button and looks like this:



Navigation in the menu is also done with arrow buttons  /  and .

You can select the between view mode and the HMI lock, each with three button pushes.



Attention! If you activate the HMI from within the quick menu, the additional PIN lock might become active, depending on your settings in the MENU. There is no extra indication here!



3.4.8 Switching the DC output on or off

The DC output of the device can be manually or remotely switched on and off. This can be restricted in manual operation by the control panel being locked.



Switching the DC output on during manual operation or digital remote control can be disabled by pin REM-SB of the built-in analog interface. For more information refer to 3.4.3.1 and example a) in 3.5.4.6.

► How to manually switch the DC output on or off

1. As long as the control panel (HMI) is not fully locked press the button . Otherwise you are asked to disable the HMI lock first.
2. This button toggles between on and off, as long as a change is not restricted by an alarm or the device is locked in "remote". The current condition is displayed with the LED in the button  (LED on = output on).

► How to remotely switch the DC output on or off via the analog interface

1. See section "3.5.4 Remote control via the analog interface (AI)" on page 39.

► How to remotely switch the DC output on or off via the digital interface

1. See the external documentation "Programming Guide ModBus & SCPI" if you are using custom software, or refer to the external documentation of LabView VIs or other software, if available, provided by the manufacturer.

PS 9000 1U Series

3.5 Remote control

3.5.1 General

Remote control is possible through any of the built-in interface ports USB, Ethernet/LAN or analog. Important here is that only the analog or any digital interface can be in control. It means that if, for example, an attempt were to be made to switch to remote control using the digital interface while analog remote control is active (pin Remote = LOW) the device would report an error at the digital interface. In the opposite direction a switch-over through pin Remote would be ignored. In both cases, however, status monitoring and reading of values are always possible.

3.5.2 Control locations

Control locations are those locations from where the device is controlled. Essentially there are two: at the device (manual operation) and outside (remote control). The following locations are defined:

Displayed location	Description
-	If neither of the other locations is displayed then <u>manual</u> control is active and access from the analog or digital interfaces is allowed. This location is not explicitly displayed
Remote	Remote control via any interface is active
Local	Remote control is locked, only <u>manual</u> operation is allowed.

Remote control may be allowed or inhibited using the setting “**Allow remote control**” (see “3.4.3.1. Menu “General Settings””). In inhibited condition the status “**Local**” will be displayed in the status area (lower half, middle) of the display. Activating the inhibit can be useful if the device is remotely controlled by software or some electronic device, but it is required to make adjustments at the device or deal with emergency, which would not be possible remotely.

Activating condition “**Local**” causes the following:

- If remote control via the digital interface is active (“**Remote**”), then remote control is immediately terminated and must be reactivated at the PC once “**Local**” is no longer active
- If remote control is via the analog interface is active (“**Remote**”), then remote operation is only interrupted until remote control is allowed again, because pin “Remote” continues to signal “remote control = on”. Exception: if the level of pin “Remote” is changed to HIGH during the “**Local**” phase

3.5.3 Remote control via a digital interface

3.5.3.1 Selecting an interface

The device only supports the built-in digital interfaces USB and Ethernet. For USB, a standard USB cable is included in the delivery, as well as a driver for Windows on CD. The USB interface requires no setup.

The Ethernet interface typically requires network setup (manual or DHCP), but can also be used with its default parameters right from the start.

The GPIB interface requires you to select a unique address in case it is connected to other GPIB bus members.

3.5.3.2 General

For the network port installation refer to “1.9.7. Ethernet port”.

The digital interface require little or no setup for operation and can be directly used with their default configuration. All specific settings will be permanently stored, but could also be reset to defaults with the setup menu item “**Reset**”.

Through the digital interface the set values (voltage, current, power) and device conditions can be set and monitored. Various other functions are also supported as described in separate programming documentation.

Changing to remote control will retain the last set values for the device until these are changed. Thus a simple voltage control by setting a target value is possible without changing any other values.

3.5.3.3 Programming

Programming details for the interfaces, the communication protocols etc. are to be found in the documentation “Programming Guide ModBus & SCPI” which is supplied on the included CD or is available as a download from the Intepro Systems website.

3.5.4 Remote control via the analog interface (AI)

3.5.4.1 General

The built-in, up to 1500 V DC galvanically-separated, 15-pole analog interface (short: AI) is on the rearside of the device offers the following possibilities:

- Remote control of current, voltage and power
- Remote status monitoring (CC/CP, CV)
- Remote alarm monitoring (OT, OVP)
- Remote monitoring of actual values
- Remote on/off switching of the DC output

Setting the **three** set values via the analog interface always takes place concurrently. It means, that for example the voltage can not be given via the AI and current and power set by the rotary knobs, or vice versa.

The OVP set value and other supervision (events) and alarm thresholds cannot be set via the AI and therefore must be adapted to the given situation before the AI is put in operation. Analog set values can be fed in by an external voltage or generated by the reference voltage on pin 3. As soon as remote control through the analog interface is activated, the values displayed will be those provided by the interface.

The AI can be operated in the common voltage ranges 0...5 V and 0...10 V in each case 0...100% of the nominal value. The selection of the voltage range can be done in the device setup. See section “3.4.3. Configuration in the setup menu” for details.

The reference voltage sent out from Pin 3 (VREF) will be adapted accordingly and is then:

0-5 V: Reference voltage = 5 V, 0...5 V set values (VSEL, CSEL, PSEL) correspond to 0...100% nominal values, 0...100% actual values correspond to 0...5 V at the actual value outputs (CMON, VMON).

0-10 V: Reference voltage = 10 V, 0...10 V set values (VSEL, CSEL, PSEL) correspond to 0...100% nominal values, 0...100% actual values correspond to 0...10 V at the actual value outputs (CMON, VMON).

Input of excess set values (e.g. >5 V in selected 5 V range or >10 V in the 10 V range) are clipped by setting the set value at 100%.

Before you begin, please read. Important notes for use of the interface:

- Analog remote control of the device must be activated by switching pin “REMOTE” (5) first. The only exception is pin REM-SB, which can be used independently since KE firmware version 2.03
- Before the hardware is connected that will control the analog interface, it shall be checked that it can't provide voltage to the pins higher than specified
- Set value input, such as VSEL, CSEL and PSEL, must not be left unconnected (i.e. floating)
- It is always required to provide all three set values at once. In case any of the set values is not used for adjustment, it can be tied to a defined level or connected to pin VREF (solder bridge or different), so it gives 100%



The analog interface is galvanically separated from DC output. Therefore do not connect any ground of the analog interface to the DC- or DC+ output!

3.5.4.2 Acknowledging device alarms

Device alarms (see 3.6.2) are always indicated in the front display and some of them are also reported as signal on the analog interface socket (see 3.5.4.3), for example the overvoltage alarm (OV), which is considered as critical.

In case of a device alarm occurring during remote control via analog interface, the DC output will be switched off the same way as in manual control. While alarms OT and OV can be monitored via the corresponding pins of the interface, other alarms like power fail (PF) can't. Those could only be monitored and detected via the actual values of voltage and current being all zero contrary to the set values.

All device alarms (OT, OV, PF, OCP and OPP) have to be acknowledged, either by the user of the device or by the controlling unit. Also see “3.6.2. Device alarm handling”. Acknowledgement is done with pin REM-SB switching the DC output off and on again, means a HIGH-LOW-HIGH edge (min. 50ms for LOW).

PS 9000 1U Series

3.5.4.3 Analog interface specification

Pin	Name	Type*	Description	Default levels	Electrical properties
1	VSEL	AI	Set voltage value	0...10 V or. 0...5 V correspond to 0..100% of U_{Nom}	Accuracy 0-5 V range: < 0.4% **** Accuracy 0-10 V range: < 0.2% **** Input impedance R_i >40 k...100 k
2	CSEL	AI	Set current value	0...10 V or. 0...5 V correspond to 0..100% of I_{Nom}	
3	VREF	AO	Reference voltage	10 V or 5 V	Tolerance < 0.2% at $I_{max} = +5$ mA Short-circuit-proof against AGND
4	DGND	POT	Ground for all digital signals		For control and status signals.
5	REMOTE	DI	Switching internal / remote control	Remote = LOW, $U_{Low} < 1$ V Internal = HIGH, $U_{High} > 4$ V Internal = Open	Voltage range = 0...30 V $I_{Max} = -1$ mA bei 5 V U_{LOW} to HIGH typ. = 3 V Rec'd sender: Open collector against DGND
6	OT	DO	Overheating or power fail*** alarm	Alarm OT= HIGH, $U_{High} > 4$ V No Alarm OT= LOW, $U_{Low} < 1$ V	Quasi open collector with pull-up against V_{cc} ** With 5 V on the pin max. flow +1 mA $I_{Max} = -10$ mA at $U_{CE} = 0,3$ V $U_{Max} = 30$ V Short-circuit-proof against DGND
7	-	-	-	-	-
8	PSEL	AI	Set power value	0...10 V or. 0...5 V correspond to 0..100% von P_{Nom}	Accuracy 0-5 V range: < 0.4% **** Accuracy 0-10 V range: < 0.2% **** Input impedance R_i >40 k...100 k
9	VMON	AO	Actual voltage	0...10 V or. 0...5 V correspond to 0..100% von U_{Nom}	Accuracy < 0.2% at $I_{Max} = +2$ mA Short-circuit-proof against AGND
10	CMON	AO	Actual current	0...10 V or. 0...5 V correspond to 0..100% von I_{Nom}	
11	AGND	POT	Ground for all analog signals		For -SEL, -MON, VREF Signals
12	-	-	-	-	-
13	REM-SB	DI	DC output OFF (DC output ON) (ACK alarms ****)	Off = LOW, $U_{Low} < 1$ V On= HIGH, $U_{High} > 4$ V On = Open	Voltage range = 0...30 V $I_{Max} = +1$ mA at 5 V Rec'd sender: Open collector against DGND
14	OVP	DO	Overvoltage alarm	Alarm OV = HIGH, $U_{High} > 4$ V No alarm OV = LOW, $U_{Low} < 1$ V	Quasi open collector with pull-up against V_{cc} ** With 5 V on the pin max. flow +1 mA
15	CV	DO	Constant voltage regulation active	CV = LOW, $U_{Low} < 1$ V CC/CP = HIGH, $U_{High} > 4$ V	$I_{Max} = -10$ mA at $U_{CE} = 0,3$ V, $U_{Max} = 30$ V Short-circuit-proof against DGND

* AI = Analog Input, AO = Analog Output, DI = Digital Input, DO = Digital Output, POT = Potential

** Internal Vcc approx. 14.3 V *** Mains blackout, mains over- or undervoltage or PFC error **** Only during remote control



The accuracy of set values, as given in the table above, is only related to the input pin and adds to the general accuracy of the corresponding value on the DC output (see technical specs)

3.5.4.4 Overview of the Sub-D Socket

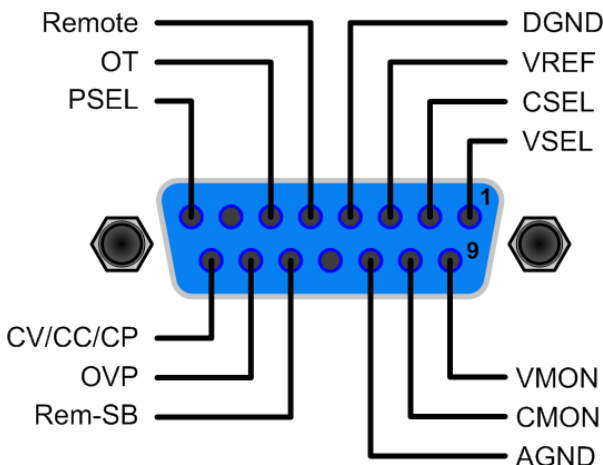

3.5.4.5 Simplified diagram of the pins

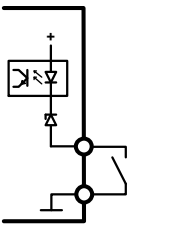
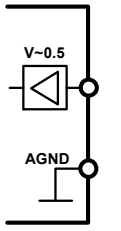
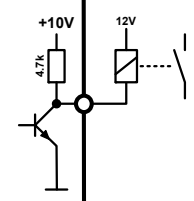
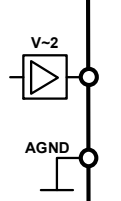
	<p>Digital Input (DI)</p> <p>The internal circuit requires that a switch with low resistance should be used (relay, switch, circuit breaker etc.) in order to send a clean signal to the DGND.</p> <p>A digital output from a circuit or PLC may not be sufficient if not an “open collector”.</p>		<p>Analog Input (AI)</p> <p>High resistance input (impedance >40 k....100 kΩ) for an OA circuit.</p>
	<p>Digital Output (DO)</p> <p>A quasi open collector, realised as high resistance pull-up against the internal supply. In condition LOW it can carry no load, merely switch, as shown in the diagram with a relay as example.</p>		<p>Analog Output (AO)</p> <p>Output from an OA circuit, only minimally impedant. See specifications table above.</p>

3.5.4.6 Application examples

a) Switching off the DC output via the pin “REM-SB”



A digital output, e.g. from a PLC, may be unable to cleanly pull down the pin as it may not be of low enough resistance. Check the specification of the controlling application. Also see pin diagrams above.

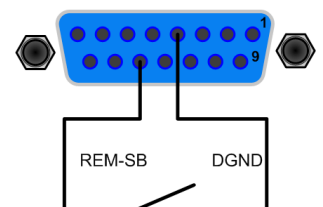

In remote control, pin REM-SB is be used to switch the DC output of the device on and off. From KE firmware version 2.03, this is also available without remote control being active.

It is recommended that a low resistance contact such as a switch, relay or transistor is used to switch the pin to ground (DGND).

The following situations can occur:

- **Remote control has been activated**

During remote control through the analog interface, only pin “REM-SB” determines the states of the DC output, according to the levels definitions in 3.5.4.3. The logical function and the default levels can be inverted by a parameter in the setup menu of the device. See 3.4.3.1.



If the pin is unconnected or the connected contact is open, the pin will be HIGH. With parameter “Analog interface REM-SB” being set to “normal”, it requests “DC output on”. So when activating remote control, the DC output will instantly switch on.

- **Remote control is not active**

In this mode of operation pin “REM-SB” can serve as lock, preventing the DC output from being switched on by any means. This results in following possible situations:

DC-output	+	Pin “REM-SB”	+	Parameter “REM-SB”	→	Behaviour
is off	+	HIGH	+	normal	→	DC output not locked. It can be switched on by pushbutton “On/Off” (front panel) or via command from digital interface.
		LOW	+	inverted	→	
	+	HIGH	+	inverted	→	DC output locked. It can not be switched on by pushbutton “On/Off” (front panel) or via command from digital interface. When trying to switch on, a popup in the display resp. an error message will be generated.
		LOW	+	normal		

PS 9000 1U Series

If the DC output is already switched on, toggling the pin will switch the DC output off, similar to what it does in analog remote control:

DC-output	+	Pin "REM-SB"	+	Parameter "REM-SB"	→	Behaviour
is on	→	HIGH	+	normal	→	DC output remains on, nothing is locked. It can be switched on or off by pushbutton or digital command.
		LOW	+	inverted		
	→	HIGH	+	inverted	→	DC output will be switched off and locked. Later it can be switched on again by toggling the pin. During lock, pushbutton or digital command can delete the request to switch on by pin.
		LOW	+	normal		

b) Remote control of current and power

Requires remote control to be activated (Pin "Remote" = LOW)

The set values VSEL and CSEL are generated from the reference voltage VREF, using potentiometers for each. Hence the power supply can selectively work in current limiting or power limiting mode. According to the specification of max. 5 mA for the VREF output, potentiometers of at least 10 kΩ must be used.

The power set value PSEL is always tied to VREF and will thus be permanently 100%.

If the control voltage is fed in from an external source it is necessary to consider the input voltage ranges for set values (0...5 V oder 0...10 V).



Use of the input voltage range 0...5 V for 0...100% set value halves the effective resolution.

Example with potentiometers

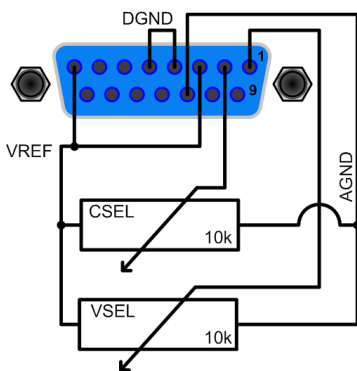

Example with external voltage source

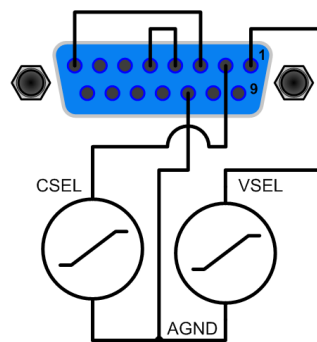

c) Reading actual values

Through the AI, the DC output values of current and voltage can be monitored. They can be read using a standard multimeter or anything else that records analog signals.

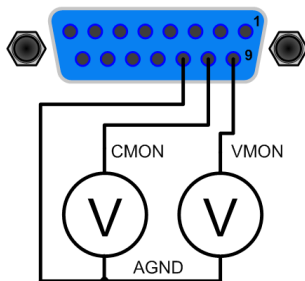

3.6 Alarms and monitoring

3.6.1 Definition of terms

Device alarms (see “3.3. Alarm conditions”) are defined as conditions like overvoltage or overtemperature, signalled in any form to the user of the device in order to take notice.

Those alarms are always indicated in the front display as readable abbreviated text, as well as status readable via digital interface when controlling or just monitoring remotely and, if activated, emitted as audible signal (buzzer). Furthermore, the most important alarms are also signalled by output pins on the analog interface.

There is furthermore an alarm history available in the submenu “**Overview**”. It counts alarms that occurred since the last time the unit was switched on, for statistics and later check.

3.6.2 Device alarm handling

A device alarm incident will usually lead to DC output switch-off. Some alarms must be acknowledged (see below), which can only happen if the cause of the alarm is not persistent anymore. Other alarms acknowledge themselves if the cause has vanished, like the OT and the PF alarm.

► How to acknowledge an alarm in the display (during manual control)

1. Push button  or  once.

► How to acknowledge an alarm on the analog interface (during analog remote control)

1. Switch off the DC output by pulling pin REM-SB to the level that corresponds to “DC output off”, then switch it on again. See section “3.5.4.6. Application examples” for levels and logic.

► How to acknowledge an alarm in the alarm buffer/status (during digital control)

1. Read the error buffer (SCPI protocol) or send a specific command to acknowledge, i.e. reset alarms (ModBus).

Some device alarms are configurable by adjusting a threshold:

Alarm	Meaning	Description	Range	Indication
OVP	OverVoltage Protection	Triggers an alarm if the DC output voltage reaches the defined threshold. This can be caused by the device being faulty or by an external source. The DC output will be switched off.	$0 \text{ V} \dots 1.1 \cdot U_{\text{Nom}}$	Display, analog IF, digital IF
OCP	OverCurrent Protection	Triggers an alarm if the DC output current reaches the defined threshold. The DC output will be switched off.	$0 \text{ A} \dots 1.1 \cdot I_{\text{Nom}}$	Display, digital IF
OPP	OverPower Protection	Triggers an alarm if the DC output power reaches the defined threshold. The DC output will be switched off.	$0 \text{ W} \dots 1.1 \cdot P_{\text{Nom}}$	Display, digital IF

These device alarms can't be configured and are based on hardware:

Alarm	Meaning	Description	Indication
PF	Power Fail	AC supply over- or undervoltage. Triggers an alarm if the AC supply is out of specification or when the device is cut from supply, for example when switching it off with the power switch. The DC output will be switched off.	Display, digital IF
OT	OverTemperature	Triggers an alarm if the internal temperature reaches a certain limit. The DC output will be switched off.	Display, analog IF, digital IF

PS 9000 1U Series

► How to configure the device alarms OVP, OCP and OPP

1. Switch off the DC output and push button **Menu** to call the setup menu.
2. In the menu navigate to “**Settings**” and push **Enter**. Then in the submenu navigate to “**Protection**” and push **Enter** again.
3. Set the limits for the equipment alarm relevant to your application if the default value of 110% of nominal is unsuitable.
4. Accept the settings with **Enter** or discard them with **ESC**.



Those thresholds are reset to defaults when using the function “Reset” in setup menu.

► How to configure the alarm sound

1. Switch off the DC output and push button **Menu** to call the setup menu.
2. In the menu navigate to “**HMI Setup**” and push **Enter**. Then in the submenu navigate to “**Alarm Sound**” and push **Enter** again.
3. In the following screen set parameter “**Alarm Sound**” to either **OFF** or **ON**.
4. Accept the settings with **Enter** or discard them with **ESC**.

3.7 Control panel (HMI) lock

To avoid the accidental alteration of a value during manual operation the rotary knobs or the key strip of the control panel (HMI) can be locked so that no alteration will be accepted without prior unlocking. You can choose between a simple lock and a PIN lock, which requires to enter the correct PIN every time someone wants to unlock the HMI.

► How to lock the HMI

1. Switch off the DC output and push button **Menu** to call the setup menu.
2. In the menu navigate to “**HMI Setup**” and push **Enter**. Then in the submenu navigate to “**HMI Lock**” and push **Enter** again.
3. Make your selection for parameter “**HMI Lock**”. With selection “**Lock all**” everything on the HMI is locked and you can’t even switch on the DC output. In order to be able to do at least that, use “**ON/OFF possible**”.
4. The lock is activated as soon as you confirm your selection with **Enter**. The device will automatically exit the menu and jump back to normal display with status “**Locked**” now being indicated.

Alternatively to the procedure above you can also lock the HMI while the DC output is switched on, by accessing the quick menu. Refer to “3.4.7. The quick menu”.

If an attempt is made to alter something while the HMI is locked, a requester appears in the display asking if the lock should be disabled.

► How to unlock the HMI

1. Rotate any knob or push any button except button **On**.
2. A request pop-up will appear: 
3. Unlock the HMI by pushing **Enter** within 5 seconds, otherwise the pop-up will disappear and the HMI remains locked. In case the HMI lock with PIN has been activated before, you are then requested to enter the correct PIN, else the HMI will remain locked.





3.8 Loading and saving a user profile

The menu “**Profiles**” serves to select between a default profile and up to 5 user profiles. A profile is a collection of all settings and set values. Upon delivery, or after a reset, all 6 profiles have the same settings and all set values are 0. If the user changes settings or sets target values then these create a work profile which can be saved to one of the 5 user profiles. These profiles or the default one can then be switched. The default profile is read-only.

The purpose of a profile is to load a set of set values, settings limits and monitoring thresholds quickly without having to readjust these. As all HMI settings are saved in the profile, including language, a profile change can also be accompanied by a change in HMI language.





On calling up the menu page and selecting a profile the most important settings can be seen, but not changed.

► How to save the current values and settings (work profile) as a user profile

1. Switch off the DC output and push button  to call the setup menu.
2. In the menu navigate to “**Profiles**” and push .
3. In the submenu (see figure to the right) select a user profile (1-5) to save to and push  again.
4. From the selection on screen chose “**Save settings into Profile n**” and overwrite that profile with the current settings and values by confirming with .

Default prof.	Profile 2	Profile 4
Profile 1	Profile 3	Profile 5

► How to load a user profile

1. Switch off the DC output and push button  to call the setup menu.
2. In the menu navigate to “**Profiles**” and push .
3. In the submenu (see figure to the right) select a user profile (1-5) to load and push  again.
4. In the screen you can now select “**View Profile n**” in order to check the stored settings and to decide, whether this profile is going to be loaded or not. Navigate to “**Load Profile n**” and confirm with  to finally load the profile into the work profile.

Default prof.	Profile 2	Profile 4
Profile 1	Profile 3	Profile 5

PS 9000 1U Series

3.9 Other applications

3.9.1 Parallel operation in Share Bus mode

Multiple devices of the same kind and model can be connected in parallel to create a system with higher total current and hence higher power. To achieve that, the units have to be connected with their DC outputs and their Share Bus. The Share Bus will balance the units in their internal voltage regulation and thus current regulation, which will result in a balanced load distribution.

In the parallel operation, a specific unit, a “Share Bus master”, has to be picked as leading unit which drives the “Share Bus slaves”. The master unit will remain fully controllable, also via analog or digital interface. The slaves, however, are restricted regarding set value adjustment. Their set values are just limits for the units while it is controlled using the Share Bus. A slave unit still can be controlled remotely, but not like a master unit. All slaves can be monitored (actual values, status), whether an analog or digital interface.



The Share Bus only control the process variable U (voltage). It means, the DC outputs of slave units have to be switched on or off either manually or remotely, which is very easy in analog remote control, because the related pins REM-SB could simply be connected in parallel, too. In digital remote control and when using the Ethernet port, all DC outputs could be switched at the same time by sending broadcast messages.

3.9.1.1 Wiring the DC outputs

The DC output of every unit in the parallel operation is simply connected to the next unit using cables with cross section according to the maximum current and with short as possible length.

3.9.1.2 Wiring the Share bus

The Share bus is wired from unit to unit with an ideally twisted pair of cables with non-critical cross section. We recommend to use 0.5 mm² to 1.0 mm².



The Share bus is poled. Take care for correct polarity of the wiring!



A maximum of 10 units can be connected through the Share bus.







3.9.1.3 Configuring units for Share Bus operation

For correct Share Bus operation in parallel connection, the formerly picked master unit has to be configured as “Share Bus master”. By default, these power supplies are set as “Share Bus slaves”, so that this configuration step is not necessary for all slave units.



One unit in the Share Bus connection must be configured as Share Bus master, or the Share Bus won't work.

► How to configure a device as Share Bus master

1. Switch off the DC output and push button  to call the setup menu. Push  again to enter sub-menu “Settings”.
2. In the submenu navigate to “General” and push  once again.
3. Use arrow button  to navigate to item “Share Bus mode” on the 2nd page and switch to setting “Master” by using the right-hand rotary knob.
4. Accept the settings with  or discard them with .

3.9.1.4 Operating the Share Bus system

After successful configuration and initialisation of the master and slave units, it is recommended to check all set values and protection settings of all slaves and possibly adjust to identical values.

The slaves can be controlled manually as usual or remotely via the analog or via digital interfaces, but they don't react to set values changes the same way as the master. They can, if needed, be monitored by reading actual values and status.

The master unit is not restricted and can be used like a stand-alone unit.

3.9.1.5 Alarms and other problem situations

Parallel operation, because of the connection of multiple units and their interaction, can cause additional problem situations which do not occur when operating individual units. For such occurrences the following regulations have been defined:

- If one or more slave units are switched off on the AC side (power switch, supply undervoltage) and come back later, they're automatically included again in the system. The remaining units will continue to work without interruption, but the entire system will provide less power
- If the DC output of the master unit is switched off because of a defect or overheating, then the total parallel system can provide no output power
- If accidentally multiple or no units are defined as master the Share Bus parallel system cannot be initialized

In situations where one or multiple units generate a device alarm like OV, PF or OT following applies:

- Any alarm of a slave is indicated on the slave's display only

3.9.2 Series connection

Series connection of two or multiple devices is possible. But for reasons of safety and isolation, some restrictions apply:



- Both, negative (DC-) and positive (DC+) output poles, are coupled to PE via type X capacitors
- None DC minus pole of any unit in the series connection must have a potential of >400 V against ground (PE)!
- The Share Bus must not be wired and used!
- Remote sensing must not be used!
- Series connection is only allowed with devices of the same kind and model, i.e. power supply with power supply, like for example PS 9080-100 1U with PS 9080-100 1U or similar models like PS/PSI 9080-120 2U

Series connection is not supported by the software and hardware of the device. It means, all units have to be controlled separately regarding set values and DC output status, whether it is manual control or digital remote control. In remote control, an almost synchronous control can be achieved by using the Ethernet ports and sending messages as broadcast, so they address multiple units at once.

The figure below depicts the exemplary series connection of three identical devices with 200 V nominal output voltage and the maximum potential shift of any DC- output against PE:

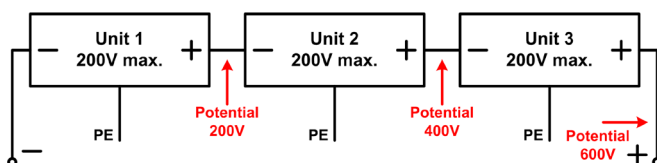

3.9.3 Operation as battery charger

A power supply can be used as a battery charger, but with some restrictions, because it misses a battery supervision and a physical separation from the load in form of a relay or contactor, which is featured with some real battery chargers as a protection.

The following have to be considered:

- No false polarity protection inside! Connecting a battery with false polarity will damage the power supply severely, even if it is not powered.
- All models of this series have an internal circuit, i.e. base load, for faster discharge of voltage when switching the DC output off or ramping voltage down. This base load would, more or less slowly, discharge the battery while the DC output is switched off, means while it is not charging. This would, however, not occur when the power supply is not powered at all. It is thus recommended to leave the DC output switched on as long as the battery is connected (equals to trickle charge) and only switch it off for connecting/disconnecting a battery.

3.9.4 Two quadrants operation (2QO)

3.9.4.1 Introduction

This way of operating refers to the use of a source, in this case a power supply of series PS 9000 1U, and a sink, in this case an electronic load of a compatible series (see „1.9.5. Share Bus-Connection“). The source and the sink function alternately in order to test a device, such as a battery, by deliberately charging and discharging it as part of a functional or final test.

The user can decide whether the system is operated manually or the power supply only as the dominant unit or both devices should be controlled by PC. We recommend to focus on the power supply, which is intended to control the load via the Share Bus connection. The two quadrants operation is only suitable for constant voltage operation (CV).

Clarification:

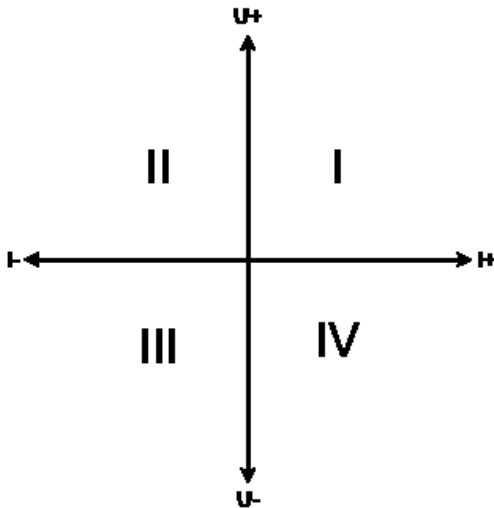
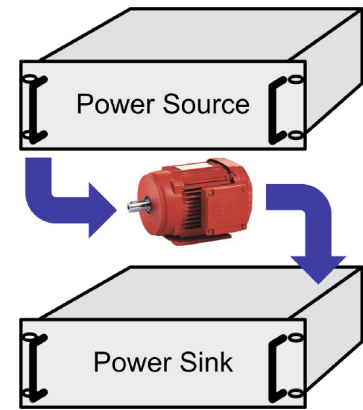

A combination of source and sink can only map the quadrants I + II. This means that only positive voltages are possible. The positive current is generated by the source or application and the negative current flows into the load..

The maximum approved limits for the application should be set in the power supply. This can be done via the interface. The electronic load should preferably be in operating mode CV. The load will then, using the Share Bus, control the output voltage of the power supply.

Typical applications:

- Fuel cells
- Capacitor tests
- Motor driven applications
- Electronic tests where a high dynamic discharge is required.

3.9.4.2 Connecting devices to a 2QO

There are a number of possibilities to connect source(s) and sink(s) to make a 2QO:

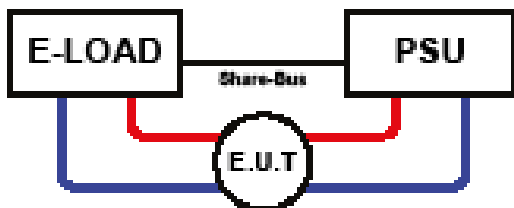

Configuration A:

1 e-load and 1 power supply, plus 1 test object (E.U.T).

This is the most common configuration for 2QO. The nominal values for U, I and P of the two devices should match as close as possible, for instance EL 9080-170 B and PS 9080-100 1U. The system is controlled by the power supply, which has to be set to “Master” for parameter “Share bus mode” in the setup menu.

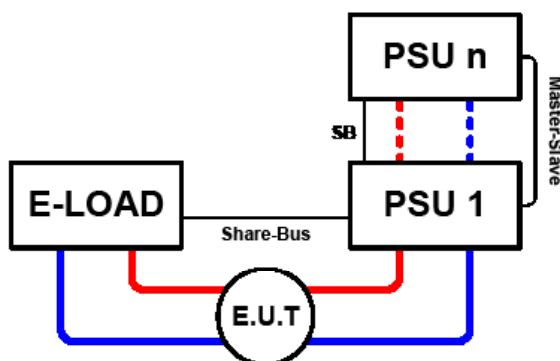

Configuration B:

1 e-load and multiple power supplies, plus 1 test object (E.U.T).

For adapting the total power of the power supply device to the possibly higher input power of the load, the power supplies are connected via Master-Slave and the load’s current is shared across the power supplies when wiring the Share bus to gain a balanced load distribution.

One PSU, preferably PSU 1, has to be set to Master for the Share bus connection.

3.9.4.3 Settings on the devices

The master-slave settings in the MENU of the load device(s) also affect the Share bus. For correct 2QO operation, all involved load units must be slaves on the Share bus. This is achieved by setting the master-slave mode to OFF or SLAVE, depending on if there is digital master-slave in use or not. For the one load that is master (setting: MASTER) in the master-slave system the additional parameter “PSI/ELR system” resp. “PSI/EL system” has to be activated.

On any of the power supplies, you need set parameter “Share bus mode” to MASTER. Also see 3.4.3.1.

For safety of the connected E.U.T / D.U.T and to prevent damage, we recommend to adjust supervision thresholds like OVP, OCP or OPP on all units to the desired levels, which will then switch off the DC output resp. the DC input in case of excess.

3.9.4.4 Restrictions

After all electronic load slaves have been connected to the Share bus with one power supply as master, they cannot limit their input voltage anymore to what you adjust as “U set” on the device. The correct voltage level comes from the master unit and has to be adjusted there.

3.9.4.5 Application example

Charging and discharging a battery with 24 V/100 Ah, using configuration A from above.

- Power supply PS 9080-100 1U with: $I_{\text{Set}} = 10 \text{ A}$ (charging current, 1/10 of rated capacity), $P_{\text{Set}} = 3000 \text{ W}$
- Electronic load EL 9080-170 B set to: $I_{\text{Set}} = \text{max. discharging current of the battery (eg. 50 A)}$, $P_{\text{Set}} = 2400 \text{ W}$, plus probably UVD = 20 V with event type “Alarm” to stop discharging at a certain low voltage threshold
- Assumption: battery has a voltage of 26 V at test start
- DC input(s) and DC output(s) of all units switched off



In this combination of devices it is recommended to always switch on the DC output of the source first and then the DC input of the sink.

1. Discharge of the battery to 24 V

Setup: Voltage on the power supply set to 24 V, DC output of power supply and DC input of load activated

Reaction: the e-load will load the battery with a maximum current of 50 A in order to discharge it to 24 V. The power supply delivers no current at this moment, because the battery voltage is still higher than what is adjusted on the power supply. The load will gradually reduce the input current in order to maintain the battery voltage at 24 V. Once the battery voltage has reached 24 V with a discharge current of approx. 0 A, the voltage will be maintained at this level by charging from the power supply.



The power supply determines the voltage setting of the load via the Share bus. In order to avoid deep discharge of the battery due to accidentally setting the voltage on the power to a very low value, it is recommended to configure the undervoltage detection feature (UVD) of the load, so it will switch off the DC input when reaching minimum allowed discharge voltage. The settings of the load, as given via the Share bus, can't be read from the load's display.

2. Charging the battery to 27 V

Setup: Voltage on the power supply set to 27 V

Reaction: the power supply will charge the battery with a maximum current of 10 A, which will gradually reduce with increasing voltage as a reaction to the changing internal resistance of the battery. The load absorbs no current at this charging phase, because it is controlled via the Share bus and set to a certain voltage, which is still higher than the actual battery voltage and the actual output voltage of the power supply. When reaching 27 V, the power supply will deliver only the current needed to maintain the battery voltage.

4. Service and maintenance

4.1 Maintenance / cleaning

The device needs no maintenance. Cleaning may be needed for the internal fans, the frequency of cleanse is depending on the ambient conditions. The fans serve to cool the components which are heated by the inherent power loss. Heavily dirt filled fans can lead to insufficient airflow and therefore the DC output would switch off too early because of overheating or possibly lead to defects.

Cleaning the internal fans can be performed with a vacuum cleaner or similar. For this the device needs to be opened.

4.2 Fault finding / diagnosis / repair

If the equipment suddenly performs in an unexpected way, which indicates a fault, or it has an obvious defect, this cannot, and must not, be repaired by the user. Contact Intepro Systems to learn the steps to be taken.

It will usually be necessary to return the device to Intepro Systems (with or without guarantee). If a return for checking or repair is to be carried out, ensure that:

- Intepro Systems has been contacted and it is clear how and where the equipment should be sent.
- the device is in fully assembled state and in suitable transport packaging, ideally the original packaging.
- a fault description in as much detail as possible is attached.
- if shipping destination is abroad, the necessary customs papers are attached.

4.2.1 Replacing a defect mains fuse

The device is protected by one fuse (T16 A, 250 V, 35 mm) which is located inside the device.

This fuse should only blow because of a defect in the AC input circuit, but could also blow when running the unit at extremely low AC supply voltage. It can be replaced for testing purposes, to find out whether it is only blown and nothing else is damaged or if there is a true defect, which cannot be repaired on location.

The device has a warranty seal which would break when opening the unit, so we recommend to contact us first in such a case during warranty period. According to the situation and problem description, we will decide what to do.

After the warranty period is over you may open the unit at will and at your own risk. This is done by pulling the AC cord first, then removing all screws for the top cover (5 x screw each on left and right side, plus 1 x screw at the rear).

It is imperative to replace the fuse only with one of same type and values.

4.2.2 Firmware update



Firmware updates should only be installed when they can eliminate existing bugs in the firmware in the device or contain new features.

The firmware of the control panel (HMI), of the communication unit (KE) and the digital controller (DR), if necessary, is updated via the rear side USB port. For this the software "EA Power Control" is needed which is included with the device or available as download from our website, together with the firmware update, or upon request.

4.3 Calibration (readjustment)

4.3.1 Preface

The devices of series PS 9000 1U feature a function to readjust the most important output values when doing a calibration and in case these values have moved out of tolerance. The readjustment is limited to compensate small differences of up to 1% or 2% of the max. value. There are several reasons which could make it necessary to readjust a unit: component aging, component deterioration, extreme ambient conditions, high frequent use

In order to determine if a value is out of tolerance, the parameter must be verified first with measurement tools of high accuracy and with at least half the error of the PS device. Only then a comparison between values displayed on the PS device and true DC output values is possible.

For example, if you want to verify and possibly readjust the output current of model PS 9080-100 1U which has 100 A maximum current, stated with a max. error of 0.2%, you can only do that by using a high current shunt with max. 0.1% error or less. Also, when measuring such high currents, it is recommended to keep the process short, in order to avoid the shunt heating up too much. It is furthermore recommended to use a shunt with at least 25% reserve.

When measuring the current with a shunt, the measurement error of the multimeter on the shunt adds to the error of the shunt and the sum of both must not exceed the max. error of the device under calibration.

4.3.1.1 Preparation

For a successful calibration and readjustment, a few tools and certain ambient conditions are required:

- A measurement device (multimeter) for voltage, with a max. error of half the PS's voltage error. That measurement device can also be used to measure the shunt voltage when readjusting the current
- If the current is also going to be calibrated: a suitable DC current shunt, ideally specified for at least 1.25 times the max. output current of the PS and with a max. error that is half or less than the max. current error of the PS device
- Normal ambient temperature of approx. 20-25°C
- Warmed up PS unit, which has been run for at least 10 minutes under 50% power
- An adjustable load, such as an electronic load, which is capable of consuming at least 102% of the max. voltage and current of the PS device

Before you can start calibrating, a few measures have to be taken:

- Let the PS device warm up in connection with the voltage / current source
- In case the remote sensing input is going to be calibrated, prepare a cable for the remote sensing connector to DC output, but leave it yet unconnected
- Abort any form of remote control, deactivate master-slave mode, set device to **U/I** mode
- Install the shunt between PS device and load and make sure the shunt is cooled somehow
- Connect external measurement device to the DC output or to the shunt, depending on whether the voltage is going to be calibrated first or the current

4.3.2 Calibration procedure

After the preparation, the device is ready to be calibrated. From now on, a certain sequence of parameter calibration is important. Generally, you don't need to calibrate all three parameters, but it is recommended to do so.

Important:



When calibrating the output voltage, the remote input "Sense" on the rear of the device has to be disconnected.

The calibration procedure, as explained below, is an example with model PS 9080-100 1U. Other models are treated the same way, with values according to the particular PS model and the required load.

4.3.2.1 Set values

► How to calibrate the DC output voltage

Voltage	Current	Save & exit
Sense volt.	Cal. date	

1. Connect a multimeter to the DC output. Connect a load and set it to approx. 5% of the nominal current of the power supply as load current, in this example let's use 4 A.
2. Enter the setup menu with **Menu**, then push **Enter**. In the submenu navigate to "**Calibration**" using the arrow buttons. In the next screen select "**Voltage**" and then "**Output value**" and confirm with **Enter**. The power supply will then switch the DC output on.
3. In the next screen the device will set a certain output voltage and start to measure it (**U-mon**). Simply confirm here with **Enter**.
4. After this, the device requests you to enter the measured output voltage from the multimeter at **Measured value**:. Enter it using the right-hand rotary knob, just like would adjust a set value. Assure yourself the value is correct and submit with **Enter**.
5. Repeat steps 3. and 4. for the next three calibration steps (total of four steps).

Should the externally measured value be too different from the internally measured value (**U-mon**), then the calibration procedure will fail and the parameter can not be readjusted by the user.

► How to calibrate the DC output current

1. Set the load to approx. 102% nominal current of the PS device, for the sample model with 100 A this would be 102 A.
2. Enter the setup menu with **Menu**, then push **Enter**. In the submenu navigate to "**Calibration**". using the arrow buttons. In the next screen select "**Current**" and then "**Output value**" and confirm with **Enter**. The power supply will then switch the DC output on.
3. In the next screen the device will set a certain current limit, being loaded by the load or sink, and start to measure the output current (**I-mon**). Simply confirm here with **Enter**.
4. After this, the device requests you to enter the output current, which you are measuring with the shunt, at **Measured value**:. Enter it using the right-hand rotary knob, just like would adjust a set value. Assure yourself the value is correct and submit with **Enter**.
5. Repeat steps 3. and 4. for the next three calibration steps (total of four steps).

Should the externally measured value be too different from the internally measured value (**I-mon**), then the calibration procedure will fail.

In case you are generally using the remote sensing feature, it is recommended to also readjust this parameter for best results. The procedure is identical to the calibration of voltage, except for it requires to have the sensing connector (Sense) on the rear to be plugged and connected with correct polarity to the DC output of the PS.

► How to calibrate the DC output voltage for remote sensing

1. Connect a load and set it to approx. 3% of the nominal current of the power supply as load current, in this example ~3 A. Connect the remote sensing input (Sense) to the load with correct polarity.
2. Put external multimeter in DC connection on the load.
3. Enter the setup menu with **Menu**, then push **Enter**. In the submenu navigate to "**Calibration**". Push **Enter** again. In the next screen select "**Sense volt.**" then "**Output value**" and confirm twice with **Enter**. The power supply will then switch the DC output on.
4. In the next screen the device will set a certain output voltage and start to measure it (**U-mon**). Simply confirm here with **Enter**.
5. After this, the device requests you to enter the measured sensing voltage from the multimeter at **Measured value**:. Enter it using the right-hand rotary knob, just like would adjust a set value. Assure yourself the value is correct and submit with **Enter**.
6. Repeat steps 4. and 5. for the next three calibration steps (total of four steps).

4.3.2.2 Actual values

Actual values of output voltage (with and without remote sensing) and output current are calibrated almost the same way as the set values, but here you don't need to enter anything, just confirm the displayed values. Please proceed the above steps and instead of "Output value" select "Actual value" in the submenus. After the device shows measured values on display, wait at least 2s for measured value to settle and then simply confirm with , until you are through all steps.

4.3.2.3 Saving calibration data

After calibration you can furthermore enter the current date. To do so, navigate to menu item "Cal. date" and enter the date in format YYYY / MM / DD and submit with .

Last but not least save the calibration data permanently confirming menu item "Save & exit" with .



Leaving the calibration selection menu without saving via "Save & exit" will discard calibration data and the procedure would have to be repeated!

5. Contact and support

5.1 General

Repairs, if not otherwise arranged between supplier and customer, will be carried out by the manufacturer. For this the device must generally be returned to the manufacturer. No RMA number is needed. It is sufficient to package the equipment adequately and send it, together with a detailed description of the fault and, if still under guarantee, a copy of the invoice, to the following address.

5.2 Contact options

Questions or problems with the operation of the device, use of optional components, with the documentation or software, can be addressed to Intepro technical support either by telephone or e-Mail.

Contact Us

United States

Intepro Systems, Inc.
14712-A Franklin Ave
Tustin, CA 92780
Tel: 1-714-953-2686
sales@inteproate.com
www.inteproate.com

United Kingdom

Intepro UK Ltd.
9 Lakeside Business Park
Swan Lane, Sandhurst Berkshire
GU47 9DN / UK
Tel: 44 012 5287 5600

China

Intepro Power
Block 7 Fourth Industrial Area
Nanyou, Nanshan District
Shenzhen, China 518052
Tel: 0086 755 86500020