

Operating Guide

PSI 9000 3U

DC High Efficiency Power Supply

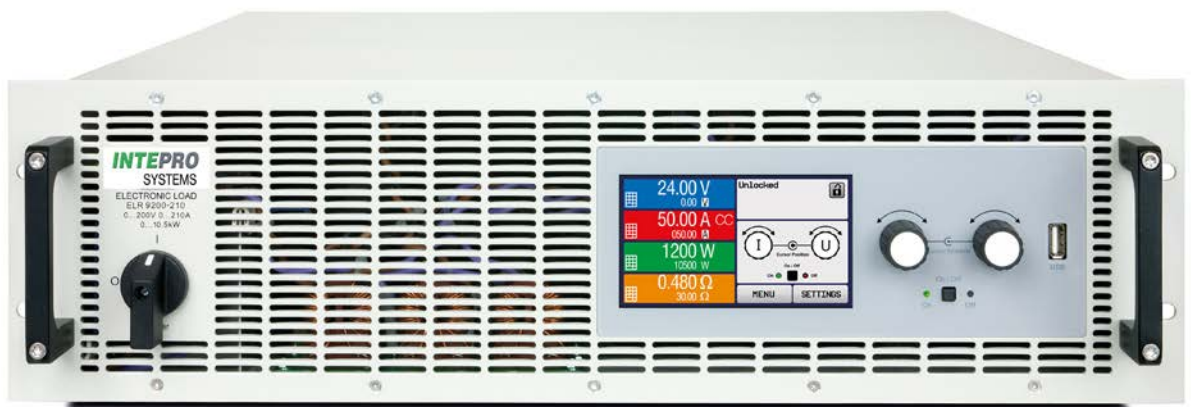

Attention! This document is only valid for devices with TFT display and firmware "KE: 2.28" (standard models) or "KE: 2.11" (GPIB models), "HMI: 2.18" and "DR: 1.6.5" or higher.



Doc ID: PSI93UTEN
Revision: 09
Date: 10/2019



TABLE OF CONTENTS

1. GENERAL

1.1	About this document	5
1.1.1	Retention and use	5
1.1.2	Copyright	5
1.1.3	Validity	5
1.1.4	Symbols and warnings	5
1.2	Warranty	5
1.3	Limitation of liability	5
1.4	Disposal of equipment	6
1.5	Product key	6
1.6	Intended usage	6
1.7	Safety	7
1.7.1	Safety notices	7
1.7.2	Responsibility of the user	8
1.7.3	Responsibility of the operator	8
1.7.4	User requirements	8
1.7.5	Alarm signals	9
1.8	Technical Data	9
1.8.1	Approved operating conditions	9
1.8.2	General technical data	9
1.8.3	Specific technical data (400 V AC models)	10
1.8.4	Specific technical data (208 V AC models)	20
1.8.5	Views	21
1.8.6	Control elements	25
1.9	Construction and function	26
1.9.1	General description	26
1.9.2	Block diagram	26
1.9.3	Scope of delivery	27
1.9.4	Accessories	27
1.9.5	Options	27
1.9.6	The control panel (HMI)	28
1.9.7	USB port type B (rear side)	31
1.9.8	Interface module slot	31
1.9.9	Analog interface	31
1.9.10	“Share” connector	32
1.9.11	“Sense” connector (remote sensing)	32
1.9.12	Master-Slave bus	32
1.9.13	GPIB port (optional)	32

2. INSTALLATION & COMMISSIONING

2.1	Transport and storage	33
2.1.1	Transport	33
2.1.2	Packaging	33
2.1.3	Storage	33
2.2	Unpacking and visual check	33
2.3	Installation	33
2.3.1	Safety procedures before installation and use	33
2.3.2	Preparation	33
2.3.3	Installing the device	34
2.3.4	Connection to AC supply	35

2.3.5	Connection to DC loads	38
2.3.6	Grounding of the DC output	39
2.3.7	Connecting the analog interface	39
2.3.8	Connection of remote sense	39
2.3.9	Installation of an interface module	40
2.3.10	Connecting the “Share” bus	41
2.3.11	Connecting the USB port (rear side)	41
2.3.12	Initial commission	41
2.3.13	Commission after a firmware update or a long period of non-use	41
2.3.14	System extension with slave units	42

3. OPERATION AND APPLICATION

3.1	Personal safety	43
3.2	Operating modes	43
3.2.1	Voltage regulation / Constant voltage	43
3.2.2	Current regulation / constant current / current limiting	44
3.2.3	Power regulation / constant power / power limiting	44
3.2.4	Internal resistance regulation	44
3.3	Alarm conditions	45
3.3.1	Power Fail	45
3.3.2	Overtemperature	45
3.3.3	Overvoltage protection	45
3.3.4	Overcurrent protection	45
3.3.5	Overpower protection	45
3.4	Manual operation	46
3.4.1	Switching on the device	46
3.4.2	Switching off the device	46
3.4.3	Configuration via MENU	46
3.4.4	Adjustment limits	52
3.4.5	Changing the operating mode	52
3.4.6	Manual adjustment of set values	53
3.4.7	Switching the main screen view	53
3.4.8	The meter bars	54
3.4.9	Switching the DC output on or off	54
3.4.10	Recording to USB stick (logging)	55
3.5	Remote control	56
3.5.1	General	56
3.5.2	Control locations	56
3.5.3	Remote control via a digital interface	56
3.5.4	Remote control via the analog interface (AI)	57
3.6	Alarms and monitoring	61
3.6.1	Definition of terms	61
3.6.2	Device alarm and event handling	61
3.7	Control panel (HMI) lock	63
3.8	Limits lock	63
3.9	Loading and saving a user profile	64
3.10	The function generator	65
3.10.1	Introduction	65

3.10.2	General.....	65
3.10.3	Method of operation.....	66
3.10.4	Manual operation	66
3.10.5	Sine wave function.....	67
3.10.6	Triangular function	68
3.10.7	Rectangular function.....	68
3.10.8	Trapezoidal function.....	69
3.10.9	DIN 40839 function	69
3.10.10	Arbitrary function	70
3.10.11	Ramp function.....	74
3.10.12	UI and IU table functions (XY table).....	74
3.10.13	Simple PV (photovoltaics) function	76
3.10.14	FC table function (fuel cell).....	77
3.10.15	Extended PV function according to EN 50530	79
3.10.16	Remote control of the function generator....	84
3.11	Other applications.....	85
3.11.1	Parallel operation in master-slave (MS).....	85
3.11.2	Series connection	89
3.11.3	Operation as battery charger.....	89
3.11.4	Two quadrants operation (2QO).....	90

4. SERVICE AND MAINTENANCE

4.1	Maintenance / cleaning.....	92
4.2	Fault finding / diagnosis / repair.....	92
4.2.1	Firmware updates	92
4.3	Calibration	93
4.3.1	Preface	93
4.3.2	Preparation.....	93
4.3.3	Calibration procedure	93

5. CONTACT AND SUPPORT

5.1	General.....	95
5.2	Contact options	95

1. General

1.1 About this document

1.1.1 Retention and use

This document is to be kept in the vicinity of the equipment for future reference and explanation of the operation of the device. This document is to be delivered and kept with the equipment in case of change of location and/or user.

1.1.2 Copyright

Reprinting, copying, also partially, usage for other purposes as foreseen of this manual are forbidden and breach may lead to legal process.

1.1.3 Validity



This manual is valid for the following equipment including derived variants:

Model	Article nr.	Model	Article nr.	Model	Article nr.
PSI 9040-170 3U	06230350	PSI 9080-340 3U	06230357	PSI 9080-510 3U	06230364
PSI 9080-170 3U	06230351	PSI 9200-140 3U	06230358	PSI 9200-210 3U	06230365
PSI 9200-70 3U	06230352	PSI 9360-80 3U	06230359	PSI 9360-120 3U	06230366
PSI 9360-40 3U	06230353	PSI 9500-60 3U	06230360	PSI 9500-90 3U	06230367
PSI 9500-30 3U	06230354	PSI 9750-40 3U	06230361	PSI 9750-60 3U	06230368
PSI 9750-20 3U	06230355	PSI 91000-30 3U	06230362	PSI 91500-30 3U	06230369
PSI 9040-340 3U	06230356	PSI 9040-510 3U	06230363	PSI 91000-40 3U	06230370

Changes and modifications for special models will be listed in a separate document.

1.1.4 Symbols and warnings

Warning and safety notices as well as general notices in this document are shown in a box with a symbol as follows:

	Symbol for a life threatening danger
	Symbol for general safety notices (instructions and damage protection bans) or important information for operation
	<i>Symbol for general notices</i>

1.2 Warranty

Intepro Systems guarantees the functional competence of the applied technology and the stated performance parameters. The warranty period begins with the delivery of free from defects equipment.

Terms of guarantee are included in the general terms and conditions (TOS) of Intepro Systems.

1.3 Limitation of liability

All statements and instructions in this manual are based on current norms and regulations, up-to-date technology and our long term knowledge and experience. The manufacturer accepts no liability for losses due to:

- Usage for purposes other than designed
- Use by untrained personnel
- Rebuilding by the customer
- Technical changes
- Use of not authorized spare parts

The actual delivered device(s) may differ from the explanations and diagrams given here due to latest technical changes or due to customized models with the inclusion of additionally ordered options.

1.4 Disposal of equipment

A piece of equipment which is intended for disposal must, according to local laws and regulations (ElektroG, WEEE) be returned to the manufacturer for scrapping, unless the person operating the piece of equipment or another, delegated person is conducting the disposal. Our equipment falls under these regulations and is accordingly marked with the following symbol:



1.5 Product key

Decoding of the product description on the label, using an example:

PSI 9 080 - 510 3U zzz

								Field for identification of installed options and/or special models 3W = Option 3W installed (GPIB port instead of Interface slot) HS = High Speed option installed WC = Water cooling installed
								Construction (not always given) 3U = 19" frame with 3U
								Maximum current of the device in Ampere
								Maximum voltage of the device in Volt
								Series: 9 = Series 9000
								Type identification: PSI = Power Supply Intelligent, always programmable



Special models are always derived from standard models and can vary in input voltage and current from those given.

1.6 Intended usage

The equipment is intended to be used, if a power supply or battery charger, only as a variable voltage and current source, or, if an electronic load, only as a variable current sink.

Typical application for a power supply is DC supply to any relevant user, for a battery charger the charging of various battery types and for electronic loads the replacement of an ohmic resistor by an adjustable DC current sink in order to load relevant voltage and current sources of any type.



- Claims of any sort due to damage caused by non-intended usage will not be accepted.
- All damage caused by non-intended usage is solely the responsibility of the operator.

1.7 Safety**1.7.1 Safety notices****Mortal danger - Hazardous voltage**

- **Electrical equipment operation means that some parts can be under dangerous voltage. Therefore all parts under voltage must be covered! This basically applies to all models, though 40 V models according to SELV can't generate hazardous DC voltage.**
- **All work on connections must be carried out under zero voltage (output not connected to load) and may only be performed by qualified and informed persons. Improper actions can cause fatal injury as well as serious material damage.**
- **Never touch cables or connectors directly after unplugging from mains supply as the danger of electric shock remains!**
- **Never touch the contacts on the DC output terminal directly after switching off the DC output, because there still can dangerous voltage present, sinking more or less slowly depending on the load! There also can be dangerous potential between negative DC output to PE or positive DC output to PE due to charged X capacitors which may not discharge.**
- **Always follow 5 safety rules when working with electric devices:**
 - **Disconnect completely**
 - **Secure against reconnection**
 - **Verify that the system is dead**
 - **Carry out earthing and short-circuiting**
 - **Provide protection from adjacent live parts**



- The equipment must only be used as intended
- The equipment is only approved for use within the connection limits stated on the product label.
- Do not insert any object, particularly metallic, through the ventilator slots
- Avoid any use of liquids near the equipment. Protect the device from wet, damp and condensation.
- For power supplies and battery chargers: do not connect users, particularly low resistance, to devices under power; sparking may occur which can cause burns as well as damage to the equipment and to the user.
- For electronic loads: do not connect power sources to equipment under power, sparking may occur which can cause burns as well as damage to the equipment and to the source.
- ESD regulations must be applied when plugging interface cards or modules into the relative slot
- Interface cards or modules may only be attached or removed after the device is switched off. It's not necessary to open the device.
- Do not connect external power sources with reversed polarity to DC input or outputs! The equipment will be damaged.
- For power supply devices: avoid where possible connecting external power sources to the DC output, and never those that can generate a higher voltage than the nominal voltage of the device.
- For electronic loads: do not connect a power source to the DC input which can generate a voltage more than 120% of the nominal input voltage of the load. The equipment isn't protected against over voltage and may be irreparably damaged.
- Never insert a network cable which is connected to Ethernet or its components into the master-slave socket on the back side of the device!
- Always configure the various protecting features against overvoltage etc. for sensitive loads to what the target application requires!

1.7.2 Responsibility of the user

The equipment is in industrial operation. Therefore the operators are governed by the legal safety regulations. Alongside the warning and safety notices in this manual the relevant safety, accident prevention and environmental regulations must also be applied. In particular the users of the equipment:

- must be informed of the relevant job safety requirements
- must work to the defined responsibilities for operation, maintenance and cleaning of the equipment
- before starting work must have read and understood the operating manual
- must use the designated and recommended safety equipment.

Furthermore, anyone working with the equipment is responsible for ensuring that the device is at all times technically fit for use.

1.7.3 Responsibility of the operator

Operator is any natural or legal person who uses the equipment or delegates the usage to a third party, and is responsible during its usage for the safety of the user, other personnel or third parties.

The equipment is in industrial operation. Therefore the operators are governed by the legal safety regulations. Alongside the warning and safety notices in this manual the relevant safety, accident prevention and environmental regulations must also be applied. In particular the operator has to

- be acquainted with the relevant job safety requirements
- identify other possible dangers arising from the specific usage conditions at the work station via a risk assessment
- introduce the necessary steps in the operating procedures for the local conditions
- regularly control that the operating procedures are current
- update the operating procedures where necessary to reflect changes in regulation, standards or operating conditions.
- define clearly and unambiguously the responsibilities for operation, maintenance and cleaning of the equipment.
- ensure that all employees who use the equipment have read and understood the manual. Furthermore the users are to be regularly schooled in working with the equipment and the possible dangers.
- provide all personnel who work with the equipment with the designated and recommended safety equipment

Furthermore, the operator is responsible for ensuring that the device is at all times technically fit for use.

1.7.4 User requirements

Any activity with equipment of this type may only be performed by persons who are able to work correctly and reliably and satisfy the requirements of the job.

- Persons whose reaction capability is negatively influenced by e.g. drugs, alcohol or medication may not operate the equipment.
- Age or job related regulations valid at the operating site must always be applied.



Danger for unqualified users

Improper operation can cause person or object damage. Only persons who have the necessary training, knowledge and experience may use the equipment.

Delegated persons are those who have been properly and demonstrably instructed in their tasks and the attendant dangers.

Qualified persons are those who are able through training, knowledge and experience as well as knowledge of the specific details to carry out all the required tasks, identify dangers and avoid personal and other risks.

All work on electrical equipment may only be performed by qualified electricians.

1.7.5 Alarm signals

The equipment offers various possibilities for signalling alarm conditions, however, not for danger situations. The signals may be optical (on the display as text), acoustic (piezo buzzer) or electronic (status output of the analog interface). All alarms will cause the device to switch off the DC output.

The meaning of the signals is as follows:

Signal OT (OverTemperature)	<ul style="list-style-type: none"> • Overheating of the device • DC output will be switched off • Non-critical
Signal OVP (OverVoltage)	<ul style="list-style-type: none"> • Overvoltage shutdown of the DC output due to high voltage entering the device or generated by the device itself due to a defect • Critical! The device and/or the load could be damaged
Signal OCP (OverCurrent)	<ul style="list-style-type: none"> • Shutdown of the DC output due to excess of the preset limit • Non-critical, protects the load from excessive current consumption
Signal OPP (OverPower)	<ul style="list-style-type: none"> • Shutdown of the DC output due to excess of the preset limit • Non-critical, protects the load from excessive power consumption
Signal PF (Power Fail)	<ul style="list-style-type: none"> • DC output shutdown due to AC undervoltage or defect in the AC input • Critical on overvoltage! AC input circuit could be damaged

1.8 Technical Data

1.8.1 Approved operating conditions

- Use only inside dry buildings
- Ambient temperature 0-50°C (32...122°F)
- Operational altitude: max. 2000 m (1.242 mi) above sea level
- Max 80% relative humidity, not condensing

1.8.2 General technical data

Display: Colour TFT touch screen with gorilla glass, 4.3", 480pt x 272pt, capacitive

Controls: 2 rotary knobs with pushbutton function, 1 pushbutton

The nominal values for the device determine the maximum adjustable ranges.

1.8.3 Specific technical data (400 V AC models)

3.3 kW / 5 kW	Model 400 V				
	PSI 9040-170	PSI 9080-170	PSI 9200-70	PSI 9360-40	PSI 9500-30
AC Input					
Voltage (L-L), Frequency	340...460 V AC, 45 - 65 Hz				
Connection	2ph, PE	2ph, PE	2ph, PE	2ph, PE	2ph, PE
Fusing (internal)	2x T16 A	2x T16 A	2x T16 A	2x T16 A	2x T16 A
Leak current	< 3.5 mA	< 3.5 mA	< 3.5 mA	< 3.5 mA	< 3.5 mA
Power factor	> 0.99	> 0.99	> 0.99	> 0.99	> 0.99
DC Output					
Max. output voltage U_{Max}	40 V	80 V	200 V	360 V	500 V
Max. output current I_{Max}	170 A	170 A	70 A	40 A	30 A
Max. output power P_{Max}	3.3 kW	5 kW	5 kW	5 kW	5 kW
Overvoltage protection range	0...44 V	0...88 V	0...220 V	0...396 V	0...550 V
Overcurrent protection range	0...187 A	0...187 A	0...77 A	0...44 A	0...33 A
Overpower protection range	0...3.63 kW	0...5.50 kW	0...5.50 kW	0...5.50 kW	0...5.50 kW
Temperature coefficient for set values Δ/K	Voltage / current: 100 ppm				
Output capacitance (approx.)	8500 μ F	8500 μ F	2500 μ F	400 μ F	250 μ F
Voltage regulation					
Adjustment range	0...40.8 V	0...81.6 V	0...204 V	0...367.2 V	0...510 V
Accuracy ⁽¹⁾ (at 23 \pm 5 $^{\circ}$ C / 73 \pm 9 $^{\circ}$ F)	< 0.1% U_{Max}	< 0.1% U_{Max}	< 0.1% U_{Max}	< 0.1% U_{Max}	< 0.1% U_{Max}
Line regulation at \pm 10% ΔU_{AC}	< 0.02% U_{Max}	< 0.02% U_{Max}	< 0.02% U_{Max}	< 0.02% U_{Max}	< 0.02% U_{Max}
Load regulation at 0...100% load	< 0.05% U_{Max}	< 0.05% U_{Max}	< 0.05% U_{Max}	< 0.05% U_{Max}	< 0.05% U_{Max}
Rise time 10...90% ΔU	Max. 30 ms	Max. 30 ms	Max. 30 ms	Max. 30 ms	Max. 30 ms
Transient time after load step	< 1.5 ms	< 1.5 ms	< 1.5 ms	< 1.5 ms	< 1.5 ms
Display: Resolution	See section „1.9.6.4. Resolution of the displayed values“				
Display: Accuracy ⁽⁴⁾	\leq 0.2% U_{Max}	\leq 0.2% U_{Max}	\leq 0.2% U_{Max}	\leq 0.2% U_{Max}	\leq 0.2% U_{Max}
Ripple ⁽²⁾	< 200 mV _{PP} < 16 mV _{RMS}	< 200 mV _{PP} < 16 mV _{RMS}	< 300 mV _{PP} < 40 mV _{RMS}	< 550 mV _{PP} < 65 mV _{RMS}	< 350 mV _{PP} < 70 mV _{RMS}
Remote sensing compensation	Max. 5% U_{Max}	Max. 5% U_{Max}	Max. 5% U_{Max}	Max. 5% U_{Max}	Max. 5% U_{Max}
Fall time at no load after switching DC output off	Down from 100% to <60 V: less than 10 s				
Current regulation					
Adjustment range	0...173.4 A	0...173.4 A	0...71.4 A	0...40.8 A	0...30.6 A
Accuracy ⁽¹⁾ (at 23 \pm 5 $^{\circ}$ C / 73 \pm 9 $^{\circ}$ F)	< 0.2% I_{Max}	< 0.2% I_{Max}	< 0.2% I_{Max}	< 0.2% I_{Max}	< 0.2% I_{Max}
Line regulation at \pm 10% ΔU_{AC}	< 0.05% I_{Max}	< 0.05% I_{Max}	< 0.05% I_{Max}	< 0.05% I_{Max}	< 0.05% I_{Max}
Load regulation at 0...100% ΔU_{OUT}	< 0.15% I_{Max}	< 0.15% I_{Max}	< 0.15% I_{Max}	< 0.15% I_{Max}	< 0.15% I_{Max}
Ripple ⁽²⁾	< 80 mA _{RMS}	< 80 mA _{RMS}	< 22 mA _{RMS}	< 5.2 mA _{RMS}	< 16 mA _{RMS}
Display: Resolution	See section „1.9.6.4. Resolution of the displayed values“				
Display: Accuracy ⁽⁴⁾	\leq 0.2% I_{Max}	\leq 0.2% I_{Max}	\leq 0.2% I_{Max}	\leq 0.2% I_{Max}	\leq 0.2% I_{Max}
Power regulation					
Adjustment range	0...3.37 kW	0...5.1 kW	0...5.1 kW	0...5.1 kW	0...5.1 kW
Accuracy ⁽¹⁾ (at 23 \pm 5 $^{\circ}$ C / 73 \pm 9 $^{\circ}$ F)	< 1% P_{Max}	< 1% P_{Max}	< 1% P_{Max}	< 1% P_{Max}	< 1% P_{Max}
Line regulation at \pm 10% ΔU_{AC}	< 0.05% P_{Max}	< 0.05% P_{Max}	< 0.05% P_{Max}	< 0.05% P_{Max}	< 0.05% P_{Max}
Load reg. at 10-90% ΔU_{OUT} * ΔI_{OUT}	< 0.75% P_{Max}	< 0.75% P_{Max}	< 0.75% P_{Max}	< 0.75% P_{Max}	< 0.75% P_{Max}
Display: Resolution	See section „1.9.6.4. Resolution of the displayed values“				
Display: Accuracy ⁽⁴⁾	\leq 0.75% P_{Max}	\leq 0.8% P_{Max}	\leq 0.8% P_{Max}	\leq 0.8% P_{Max}	\leq 0.8% P_{Max}
Efficiency ⁽³⁾	\approx 93%	\approx 93%	\approx 95%	\approx 95%	\approx 95,5%

(1) Related to the nominal values, the accuracy defines the maximum deviation between an adjusted values and the true (actual) value.

Example: a 80 V model has min. 0.1% voltage accuracy, that is 80 mV. When adjusting the voltage to 5 V, the actual value is allowed to differ max. 80 mV, which means it might be between 4.92 V and 5.08 V.

(2) RMS value: LF 0...300 kHz, PP value: HF 0...20MHz

(3) Typical value at 100% output voltage and 100% power

(4) The display error adds to the error of the related actual value on the DC output

3.3 kW / 5 kW	Model 400 V				
	PSI 9040-170	PSI 9080-170	PSI 9200-70	PSI 9360-40	PSI 9500-30
Internal resistance regulation					
Adjustment range	0...7 Ω	0...14 Ω	0...85 Ω	0...270 Ω	0...500 Ω
Accuracy ⁽¹⁾	≤2% of max. resistance ± 0.3% of rated current				
Display: Resolution	See section „1.9.6.4. Resolution of the displayed values“				
Analog interface ⁽²⁾					
Set value inputs	U, I, P, R				
Actual value output	U, I				
Control signals	DC on/off, remote control on/off, resistance mode on/off				
Status signals	CV, OVP, OT				
Galvanic isolation to the device	Max. 725 V DC				
Sample rate of inputs & outputs	500 Hz				
Insulation					
Allowed float (potential shift) on the DC output:					
Negative output to PE Max.	±400 V DC	±400 V DC	±400 V DC	±400 V DC	±725 V DC
Positive output to PE Max.	±400 V DC	±400 V DC	±600 V DC	±600 V DC	±1000 V DC
AC input <-> PE	2.5 kV DC				
AC input <-> DC output	2.5 kV DC				
Miscellaneous					
Cooling	Temperature controlled fans, front inlet, rear exhaust				
Ambient temperature	0..50°C (32...122°F)				
Storage temperature	-20...70°C (-4...158°F)				
Humidity	< 80%, not condensing				
Standards	IEC 61010:2010 EMC TÜV approved acc. IEC 61000-6-2:2005 and IEC 61000-6-3:2006 Class B				
Overtoltage category	2				
Protection class	1				
Pollution degree	2				
Operational altitude	< 2000 m (1.242 mi)				
Digital interfaces					
Featured	1x USB-B for communication, 1x USB-A for functions, 1x GPIB (optional)				
Slot (standard version)	Optional: CANopen, Profibus, Profinet, RS232, CAN, Ethernet, ModBus TCP, Ether-CAT				
Galvanic isolation from device	Max. 725 V DC				
Terminals					
Rear side	Share Bus, DC output, AC input, remote sensing, analog interface, USB-B, master-slave bus, interface module slot				
Front side	USB-A				
Dimensions					
Enclosure (WxHxD)	19" x 3U x 609 mm (24")				
Total (WxHxD)	483 x 133 x 714 mm (19" x 5.2x 28.1")				
Weight	≈ 17 kg (37.5 lb)	≈ 17 kg (37.5 lb)	≈ 17 kg (37.5 lb)	≈ 17 kg (37.5 lb)	≈ 17 kg (37.5 lb)
Article number ⁽³⁾	06230350	06230351	06230352	06230353	06230354

(1 Related to the nominal values, the accuracy defines the maximum deviation between an adjusted values and the true (actual) value

(2 For technical specifications of the analog interface see „3.5.4.4 Analog interface specification“ on page 58

(3 Article number of the standard version, devices with options will have a different number

5 kW / 6.6 kW / 10 kW	Model 400 V				
	PSI 9750-20	PSI 9040-340	PSI 9040-510	PSI 9080-340	PSI 9200-140
AC Input					
Voltage (L-L)	340...460 V AC				
Connection	2ph,PE	3ph,PE	3ph,PE	3ph,PE	3ph,PE
Frequency	45 - 65 Hz	45 - 65 Hz	45 - 65 Hz	45 - 65 Hz	45 - 65 Hz
Fusing (internal)	2x T16 A	4x T16 A	6x T16 A	4x T16 A	4x T16 A
Leak current	< 3.5 mA	< 3.5 mA	< 3.5 mA	< 3.5 mA	< 3.5 mA
Power factor	> 0.99	> 0.99	> 0.99	> 0.99	> 0.99
DC Output					
Max. output voltage U_{Max}	750 V	40 V	40 V	80 V	200 V
Max. output current I_{Max}	20 A	340 A	510 A	340 A	140 A
Max. output power P_{Max}	5 kW	6.6 kW	10 kW	10 kW	10 kW
Overvoltage protection range	0...825 V	0...44 V	0...44 V	0...88 V	0...220 V
Overcurrent protection range	0...22 A	0...374 A	0...561 A	0...374 A	0...154 A
Overpower protection range	0...5.50 kW	0...7.26 kW	0...11.00 kW	0...11.00 kW	0...11.00 kW
Temperature coefficient for set values Δ/K	Voltage / current: 100 ppm				
Output capacitance (approx.)	100 μ F	16900 μ F	25380 μ F	16900 μ F	5040 μ F
Voltage regulation					
Adjustment range	0...765 V	0...40.8 V	0...40.8 V	0...81.6 V	0...204 V
Accuracy ⁽¹⁾ (at 23 \pm 5°C / 73 \pm 9°F)	< 0.1% U_{Max}	< 0.1% U_{Max}	< 0.1% U_{Max}	< 0.1% U_{Max}	< 0.1% U_{Max}
Line regulation at \pm 10% ΔU_{AC}	< 0.02% U_{Max}	< 0.02% U_{Max}	< 0.02% U_{Max}	< 0.02% U_{Max}	< 0.02% U_{Max}
Load regulation at 0...100% load	< 0.05% U_{Max}	< 0.05% U_{Max}	< 0.05% U_{Max}	< 0.05% U_{Max}	< 0.05% U_{Max}
Rise time 10...90% ΔU	Max. 30 ms	Max. 30 ms	Max. 30 ms	Max. 30 ms	Max. 30 ms
Transient time after load step	< 1.5 ms	< 1.5 ms	< 1.5 ms	< 1.5 ms	< 1.5 ms
Display: Resolution	See section „1.9.6.4. Resolution of the displayed values“				
Display: Accuracy ⁽⁴⁾	\leq 0.2% U_{Max}	\leq 0.2% U_{Max}	\leq 0.2% U_{Max}	\leq 0.2% U_{Max}	\leq 0.2% U_{Max}
Ripple ⁽²⁾	< 800 mV _{PP} < 200 mV _{RMS}	< 320 mV _{PP} < 25 mV _{RMS}	< 320 mV _{PP} < 25 mV _{RMS}	< 320 mV _{PP} < 25 mV _{RMS}	< 300 mV _{PP} < 40 mV _{RMS}
Remote sensing compensation	Max. 5% U_{Max}	Max. 5% U_{Max}	Max. 5% U_{Max}	Max. 5% U_{Max}	Max. 5% U_{Max}
Fall time at no load after switching DC output off	Down from 100% to <60 V: less than 10 s				
Current regulation					
Adjustment range	0...20.4 A	0...346.8 A	0...520.2 A	0...346.8 A	0...142.8 A
Accuracy ⁽¹⁾ (at 23 \pm 5°C / 73 \pm 9°F)	< 0.2% I_{Max}	< 0.2% I_{Max}	< 0.2% I_{Max}	< 0.2% I_{Max}	< 0.2% I_{Max}
Line regulation at \pm 10% ΔU_{AC}	< 0.05% I_{Max}	< 0.05% I_{Max}	< 0.05% I_{Max}	< 0.05% I_{Max}	< 0.05% I_{Max}
Load regulation at 0...100% ΔU_{OUT}	< 0.15% I_{Max}	< 0.15% I_{Max}	< 0.15% I_{Max}	< 0.15% I_{Max}	< 0.15% I_{Max}
Ripple ⁽²⁾	< 16 mA _{RMS}	< 160 mA _{RMS}	< 120 mA _{RMS}	< 160 mA _{RMS}	< 44 mA _{RMS}
Display: Resolution	See section „1.9.6.4. Resolution of the displayed values“				
Display: Accuracy ⁽⁴⁾	\leq 0.2% I_{Max}	\leq 0.2% I_{Max}	\leq 0.2% I_{Max}	\leq 0.2% I_{Max}	\leq 0.2% I_{Max}
Power regulation					
Adjustment range	0...5.1 kW	0...6.73 kW	0...10.2 kW	0...10.2 kW	0...10.2 kW
Accuracy ⁽¹⁾ (at 23 \pm 5°C / 73 \pm 9°F)	< 1% P_{Max}	< 1% P_{Max}	< 1% P_{Max}	< 1% P_{Max}	< 1% P_{Max}
Line regulation at \pm 10% ΔU_{AC}	< 0.05% P_{Max}	< 0.05% P_{Max}	< 0.05% P_{Max}	< 0.05% P_{Max}	< 0.05% P_{Max}
Load reg. at 10-90% ΔU_{OUT} * ΔI_{OUT}	< 0.75% P_{Max}	< 0.75% P_{Max}	< 0.75% P_{Max}	< 0.75% P_{Max}	< 0.75% P_{Max}
Display: Resolution	See section „1.9.6.4. Resolution of the displayed values“				
Display: Accuracy ⁽⁴⁾	\leq 0.8% P_{Max}	\leq 0.7% P_{Max}	\leq 0.7% P_{Max}	\leq 0.8% P_{Max}	\leq 0.85% P_{Max}
Efficiency ⁽³⁾	\approx 94%	\approx 93%	\approx 93%	\approx 93%	\approx 95%

(1) Related to the nominal values, the accuracy defines the maximum deviation between an adjusted values and the true (actual) value.
Example: a 80 V model has min. 0.1% voltage accuracy, that is 80 mV. When adjusting the voltage to 5 V, the actual value is allowed to differ max. 80 mV, which means it might be between 4.92 V and 5.08 V.
(2) RMS value: LF 0...300 kHz, PP value: HF 0...20MHz
(3) Typical value at 100% output voltage and 100% power
(4) The display error adds to the error of the related actual value on the DC output.

5 kW / 6.6 kW / 10 kW	<i>Model 400 V</i>				
	<i>PSI 9750-20</i>	<i>PSI 9040-340</i>	<i>PSI 9040-510</i>	<i>PSI 9080-340</i>	<i>PSI 9200-140</i>
Internal resistance regulation					
Adjustment range	0...1125 Ω	0...3,5 Ω	0...2 Ω	0...7 Ω	0...42 Ω
Accuracy ⁽¹⁾	≤2% of max. resistance ± 0.3% of rated current				
Display: Resolution	See section „1.9.6.4. Resolution of the displayed values“				
Analog interface ⁽²⁾					
Set value inputs	U, I, P, R				
Actual value output	U, I				
Control signals	DC on/off, remote control on/off, resistance mode on/off				
Status signals	CV, OVP, OT				
Galvanic isolation to the device	Max. 725 V DC				
Sample rate of inputs & outputs	500 Hz				
Insulation					
Allowed float (potential shift) on the DC output:					
Negative output to PE Max.	±725 V DC	±400 V DC	±400 V DC	±400 V DC	±400 V DC
Positive output to PE Max.	±1000 V DC	±400 V DC	±400 V DC	±400 V DC	±600 V DC
AC input <-> PE	2.5 kV DC				
AC input <-> DC output	2.5 kV DC				
Miscellaneous					
Cooling	Temperature controlled fans, front inlet, rear exhaust				
Ambient temperature	0..50°C (32...122°F)				
Storage temperature	-20...70°C (-4...158°F)				
Humidity	< 80%, not condensing				
Standards	IEC 61010:2010 EMC TÜV approved acc. IEC 61000-6-2:2005 and IEC 61000-6-3:2006 Class B				
Overvoltage category	2				
Protection class	1				
Pollution degree	2				
Operational altitude	< 2000 m (1.242 mi)				
Digital interfaces					
Featured	1x USB-B for communication, 1x USB-A for functions, 1x GPIB (optional)				
Slot (standard version)	Optional: CANopen, Profibus, Profinet, RS232, CAN, Ethernet, ModBus TCP, Ether-CAT				
Galvanic isolation from device	Max. 725 V DC				
Terminals					
Rear side	Share Bus, DC output, AC input, remote sensing, analog interface, USB-B, master-slave bus, Interface module slot				
Front side	USB-A				
Dimensions					
Enclosure (WxHxD)	19" x 3U x 609 mm (24")				
Total (WxHxD)	483 x 133 x 714 mm (19" x 5.2" x 28.1")				
Weight	≈ 17 kg (37.5 lb)	≈ 24 kg (52.9 lb)	≈ 30 kg (66.1 lb)	≈ 24 kg (52.9 lb)	≈ 24 kg (52.9 lb)
Article number ⁽³⁾	06230355	06230356	06230363	06230357	06230358

(1 Related to the nominal values, the accuracy defines the maximum deviation between an adjusted values and the true (actual) value

(2 For technical specifications of the analog interface see „3.5.4.4 Analog interface specification“ on page 58

(3 Article number of the standard version, devices with options will have a different number

10 kW / 15 kW	Model 400 V				
	PSI 9360-80	PSI 9500-60	PSI 9750-40	PSI 91000-30	PSI 9080-510
AC Input					
Voltage (L-L)	340...460 V AC				
Connection	3ph,PE	3ph,PE	3ph,PE	3ph,PE	3ph,PE
Frequency	45 - 65 Hz	45 - 65 Hz	45 - 65 Hz	45 - 65 Hz	45 - 65 Hz
Fusing (internal)	4x T16 A	4x T16 A	4x T16 A	4x T16 A	6x T16 A
Leak current	< 3.5 mA	< 3.5 mA	< 3.5 mA	< 3.5 mA	< 3.5 mA
Power factor	> 0.99	> 0.99	> 0.99	> 0.99	> 0.99
DC Output					
Max. output voltage U_{Max}	360 V	500 V	750 V	1000 V	80 V
Max. output current I_{Max}	80 A	60 A	40 A	30 A	510 A
Max. output power P_{Max}	10 kW	10 kW	10 kW	10 kW	15 kW
Overvoltage protection range	0...396 V	0...550 V	0...825 V	0...1100 V	0...88 V
Overcurrent protection range	0...88 A	0...66 A	0...44 A	0...33 A	0...561 A
Overpower protection range	0...11.00 kW	0...11.00 kW	0...11.00 kW	0...11.00 kW	0...16.50 kW
Temperature coefficient for set values Δ/K	Voltage / current: 100 ppm				
Output capacitance (approx.)	800 μ F	500 μ F	210 μ F	127 μ F	25380 μ F
Voltage regulation					
Adjustment range	0...367.2 V	0...510 V	0...765 V	0...1020 V	0...81.6 V
Accuracy ⁽¹⁾ (at 23 \pm 5°C / 73 \pm 9°F)	< 0.1% U_{Max}	< 0.1% U_{Max}	< 0.1% U_{Max}	< 0.1% U_{Max}	< 0.1% U_{Max}
Line regulation at \pm 10% ΔU_{AC}	< 0.02% U_{Max}	< 0.02% U_{Max}	< 0.02% U_{Max}	< 0.02% U_{Max}	< 0.02% U_{Max}
Load regulation at 0...100% load	< 0.05% U_{Max}	< 0.05% U_{Max}	< 0.05% U_{Max}	< 0.05% U_{Max}	< 0.05% U_{Max}
Rise time 10...90% ΔU	Max. 30 ms	Max. 30 ms	Max. 30 ms	Max. 30 ms	Max. 30 ms
Transient time after load step	< 1.5 ms	< 1.5 ms	< 1.5 ms	< 1.5 ms	< 1.5 ms
Display: Resolution	See section „1.9.6.4. Resolution of the displayed values“				
Display: Accuracy ⁽⁴⁾	\leq 0.2% U_{Max}	\leq 0.2% U_{Max}	\leq 0.2% U_{Max}	\leq 0.2% U_{Max}	\leq 0.2% U_{Max}
Ripple ⁽²⁾	< 550 mV _{PP} < 65 mV _{RMS}	< 350 mV _{PP} < 70 mV _{RMS}	< 800 mV _{PP} < 200 mV _{RMS}	< 1600 mV _{PP} < 350 mV _{RMS}	< 320 mV _{PP} < 25 mV _{RMS}
Remote sensing compensation	Max. 5% U_{Max}	Max. 5% U_{Max}	Max. 5% U_{Max}	Max. 5% U_{Max}	Max. 5% U_{Max}
Fall time at no load after switching DC output off	Down from 100% to <60 V: less than 10 s				
Current regulation					
Adjustment range	0...81.6 A	0...61.2 A	0...40.8 A	0...30.6 A	0...520.2 A
Accuracy ⁽¹⁾ (at 23 \pm 5°C / 73 \pm 9°F)	< 0.2% I_{Max}	< 0.2% I_{Max}	< 0.2% I_{Max}	< 0.2% I_{Max}	< 0.2% I_{Max}
Line regulation at \pm 10% ΔU_{AC}	< 0.05% I_{Max}	< 0.05% I_{Max}	< 0.05% I_{Max}	< 0.05% I_{Max}	< 0.05% I_{Max}
Load regulation at 0...100% ΔU_{OUT}	< 0.15% I_{Max}	< 0.15% I_{Max}	< 0.15% I_{Max}	< 0.15% I_{Max}	< 0.15% I_{Max}
Ripple ⁽²⁾	< 10.4 mA _{RMS}	< 32 mA _{RMS}	< 32 mA _{RMS}	< 22 mA _{RMS}	< 240 mA _{RMS}
Display: Resolution	See section „1.9.6.4. Resolution of the displayed values“				
Display: Accuracy ⁽⁴⁾	\leq 0.2% I_{Max}	\leq 0.2% I_{Max}	\leq 0.2% I_{Max}	\leq 0.2% I_{Max}	\leq 0.2% I_{Max}
Power regulation					
Adjustment range	0...10.2 kW	0...10.2 kW	0...10.2 kW	0...10.2 kW	0...15.3 kW
Accuracy ⁽¹⁾ (at 23 \pm 5°C / 73 \pm 9°F)	< 1% P_{Max}	< 1% P_{Max}	< 1% P_{Max}	< 1% P_{Max}	< 1% P_{Max}
Line regulation at \pm 10% ΔU_{AC}	< 0.05% P_{Max}	< 0.05% P_{Max}	< 0.05% P_{Max}	< 0.05% P_{Max}	< 0.05% P_{Max}
Load reg. at 10-90% ΔU_{OUT} * ΔI_{OUT}	< 0.75% P_{Max}	< 0.75% P_{Max}	< 0.75% P_{Max}	< 0.75% P_{Max}	< 0.75% P_{Max}
Display: Resolution	See section „1.9.6.4. Resolution of the displayed values“				
Display: Accuracy ⁽⁴⁾	\leq 0.8% P_{Max}	\leq 0.85% P_{Max}	\leq 0.85% P_{Max}	\leq 0.85% P_{Max}	\leq 0.8% P_{Max}
Efficiency ⁽³⁾	\approx 93%	\approx 95%	\approx 94%	\approx 95%	\approx 93%

(1) Related to the nominal values, the accuracy defines the maximum deviation between an adjusted values and the true (actual) value.
Example: a 80 V model has min. 0.1% voltage accuracy, that is 80 mV. When adjusting the voltage to 5 V, the actual value is allowed to differ max. 80 mV, which means it might be between 4.92 V and 5.08 V.
(2) RMS value: LF 0...300 kHz, PP value: HF 0...20MHz
(3) Typical value at 100% output voltage and 100% power
(4) The display error adds to the error of the related actual value on the DC output.

10 kW / 15 kW	<i>Model 400 V</i>				
	<i>PSI 9360-80</i>	<i>PSI 9500-60</i>	<i>PSI 9750-40</i>	<i>PSI 91000-30</i>	<i>PSI 9080-510</i>
Internal resistance regulation					
Adjustment range	0...135 Ω	0...250 Ω	0...562 Ω	0...1000 Ω	0...5 Ω
Accuracy ⁽¹⁾	≤2% of max. resistance ± 0.3% of rated current				
Display: Resolution	See section „1.9.6.4. Resolution of the displayed values“				
Analog interface ⁽²⁾					
Set value inputs	U, I, P, R				
Actual value output	U, I				
Control signals	DC on/off, remote control on/off, resistance mode on/off				
Status signals	CV, OVP, OT				
Galvanic isolation to the device	≤725 V DC	≤725 V DC	≤725 V DC	≤1800 V DC	≤725 V DC
Sample rate of inputs & outputs	500 Hz				
Insulation					
Allowed float (potential shift) on the DC output:					
Negative output to PE Max.	±400 V DC	±725 V DC	±725 V DC	±1000 V DC	±400 V DC
Positive output to PE Max.	±600 V DC	±1000 V DC	±1000 V DC	±1500 V DC	±400 V DC
AC input <-> PE	2.5 kV DC				
AC input <-> DC output	2.5 kV DC				
Miscellaneous					
Cooling	Temperature controlled fans, front inlet, rear exhaust				
Ambient temperature	0..50°C (32...122°F)				
Storage temperature	-20...70°C (-4...158°F)				
Humidity	< 80%, not condensing				
Standards	IEC 61010:2010 EMC TÜV approved acc. IEC 61000-6-2:2005 and IEC 61000-6-3:2006 Class B				
Overvoltage category	2				
Protection class	1				
Pollution degree	2				
Operational altitude	< 2000 m (1.242 mi)				
Digital interfaces					
Featured	1x USB-B for communication, 1x USB-A for functions, 1x GPIB (optional)				
Slot (standard version)	Optional: CANopen, Profibus, Profinet, RS232, CAN, Ethernet, ModBus TCP, Ether-CAT				
Galvanic isolation from device	≤725 V DC	≤725 V DC	≤725 V DC	≤1800 V DC	≤725 V DC
Terminals					
Rear side	Share Bus, DC output, AC input, remote sensing, analog interface, USB-B, master-slave bus, Interface module slot				
Front side	USB-A				
Dimensions					
Enclosure (WxHxD)	19" x 3U x 609 mm (24")				
Total (WxHxD)	483 x 133 x 714 mm (19" x 5.2" x 28.1")				
Weight	≈ 24 kg (52.9 lb)	≈ 24 kg (52.9 lb)	≈ 24 kg (52.9 lb)	≈ 24 kg (52.9 lb)	≈ 30 kg (66.1 lb)
Article number ⁽³⁾	06230359	06230360	06230361	06230362	06230364

(1 Related to the nominal values, the accuracy defines the maximum deviation between an adjusted values and the true (actual) value

(2 For technical specifications of the analog interface see „3.5.4.4 Analog interface specification“ on page 58

(3 Article number of the standard version, devices with options will have a different number

15 kW	Model 400 V		
	PSI 9200-210	PSI 9360-120	PSI 9500-90
AC Input			
Voltage (L-L)	340...460 V AC		
Connection	3ph,PE	3ph,PE	3ph,PE
Frequency	45 - 65 Hz	45 - 65 Hz	45 - 65 Hz
Fusing (internal)	6x T16 A	6x T16 A	6x T16 A
Leak current	< 3.5 mA	< 3.5 mA	< 3.5 mA
Power factor	> 0.99	> 0.99	> 0.99
DC Output			
Max. output voltage U_{Max}	200 V	360 V	500 V
Max. output current I_{Max}	210 A	120 A	90 A
Max. output power P_{Max}	15 kW	15 kW	15 kW
Overvoltage protection range	0...220 V	0...396 V	0...550 V
Overcurrent protection range	0...231 A	0...132 A	0...99 A
Overpower protection range	0...16.50 kW	0...16.50 kW	0...16.50 kW
Temperature coefficient for set values Δ/K	Voltage / current: 100 ppm		
Output capacitance (approx.)	7560 μ F	1200 μ F	760 μ F
Voltage regulation			
Adjustment range	0...204 V	0...367.2 V	0...510 V
Accuracy ⁽¹⁾ (at 23 \pm 5°C / 73 \pm 9°F)	< 0.1% U_{Max}	< 0.1% U_{Max}	< 0.1% U_{Max}
Line regulation at \pm 10% ΔU_{AC}	< 0.02% U_{Max}	< 0.02% U_{Max}	< 0.02% U_{Max}
Load regulation at 0...100% load	< 0.05% U_{Max}	< 0.05% U_{Max}	< 0.05% U_{Max}
Rise time 10...90% ΔU	Max. 30 ms	Max. 30 ms	Max. 30 ms
Transient time after load step	< 1.5 ms	< 1.5 ms	< 1.5 ms
Display: Resolution	See section „1.9.6.4. Resolution of the displayed values“		
Display: Accuracy ⁽⁴⁾	\leq 0.2% U_{Max}	\leq 0.2% U_{Max}	\leq 0.2% U_{Max}
Ripple ⁽²⁾	< 300 mV _{PP} < 40 mV _{RMS}	< 550 mV _{PP} < 65 mV _{RMS}	< 350 mV _{PP} < 70 mV _{RMS}
Remote sensing compensation	Max. 5% U_{Max}	Max. 5% U_{Max}	Max. 5% U_{Max}
Fall time at no load after switching DC output off	Down from 100% to <60 V: less than 10 s		
Current regulation			
Adjustment range	0...214.2 A	0...122.4 A	0...91.8 A
Accuracy ⁽¹⁾ (at 23 \pm 5°C / 73 \pm 9°F)	< 0.2% I_{Max}	< 0.2% I_{Max}	< 0.2% I_{Max}
Line regulation at \pm 10% ΔU_{AC}	< 0.05% I_{Max}	< 0.05% I_{Max}	< 0.05% I_{Max}
Load regulation at 0...100% ΔU_{OUT}	< 0.15% I_{Max}	< 0.15% I_{Max}	< 0.15% I_{Max}
Ripple ⁽²⁾	< 66 mA _{RMS}	< 15.6 mA _{RMS}	< 48 mA _{RMS}
Display: Resolution	See section „1.9.6.4. Resolution of the displayed values“		
Display: Accuracy ⁽⁴⁾	\leq 0.2% I_{Max}	\leq 0.2% I_{Max}	\leq 0.2% I_{Max}
Power regulation			
Adjustment range	0...15.3 kW	0...15.3 kW	0...15.3 kW
Accuracy ⁽¹⁾ (at 23 \pm 5°C / 73 \pm 9°F)	< 1% P_{Max}	< 1% P_{Max}	< 1% P_{Max}
Line regulation at \pm 10% ΔU_{AC}	< 0.05% P_{Max}	< 0.05% P_{Max}	< 0.05% P_{Max}
Load reg. at 10-90% ΔU_{OUT} * ΔI_{OUT}	< 0.75% P_{Max}	< 0.75% P_{Max}	< 0.75% P_{Max}
Display: Resolution	See section „1.9.6.4. Resolution of the displayed values“		
Display: Accuracy ⁽⁴⁾	\leq 0.8% P_{Max}	\leq 0.85% P_{Max}	\leq 0.85% P_{Max}
Efficiency ⁽³⁾	\approx 95%	\approx 94%	\approx 95%

(1) Related to the nominal values, the accuracy defines the maximum deviation between an adjusted values and the true (actual) value.
Example: a 80 V model has min. 0.1% voltage accuracy, that is 80 mV. When adjusting the voltage to 5 V, the actual value is allowed to differ max. 80 mV, which means it might be between 4.92 V and 5.08 V.
(2) RMS value: LF 0...300 kHz, PP value: HF 0...20MHz
(3) Typical value at 100% output voltage and 100% power
(4) The display error adds to the error of the related actual value on the DC output.

15 kW	<i>Model 400 V</i>		
	<i>PSI 9200-210</i>	<i>PSI 9360-120</i>	<i>PSI 9500-90</i>
Internal resistance regulation			
Adjustment range	0...28 Ω	0...90 Ω	0...166 Ω
Accuracy ⁽¹⁾	≤2% of max. resistance ± 0.3% of rated current		
Display: Resolution	See section „1.9.6.4. Resolution of the displayed values“		
Analog interface ⁽²⁾			
Set value inputs	U, I, P, R		
Actual value output	U, I		
Control signals	DC on/off, remote control on/off, resistance mode on/off		
Status signals	CV, OVP, OT		
Galvanic isolation to the device	Max. 725 V DC		
Sample rate of inputs & outputs	500 Hz		
Insulation			
Allowed float (potential shift) on the DC output:			
Negative output to PE Max.	±400 V DC	±400 V DC	±725 V DC
Positive output to PE Max.	±600 V DC	±600 V DC	±1000 V DC
AC input <-> PE	2.5 kV DC		
AC input <-> DC output	2.5 kV DC		
Miscellaneous			
Cooling	Temperature controlled fans, front inlet, rear exhaust		
Ambient temperature	0..50°C (32...122°F)		
Storage temperature	-20...70°C (-4...158°F)		
Humidity	< 80%, not condensing		
Standards	IEC 61010:2010 EMC TÜV approved acc. IEC 61000-6-2:2005 and IEC 61000-6-3:2006 Class B		
Overvoltage category	2		
Protection class	1		
Pollution degree	2		
Operational altitude	< 2000 m (1.242 mi)		
Digital interfaces			
Featured	1x USB-B for communication, 1x USB-A for functions, 1x GPIB (optional)		
Slot (standard version)	Optional: CANopen, Profibus, Profinet, RS232, CAN, Ethernet, ModBus TCP, Ether-CAT		
Galvanic isolation from device	Max. 725 V DC		
Terminals			
Rear side	Share Bus, DC output, AC input, remote sensing, analog interface, USB-B, master-slave bus, Interface module slot		
Front side	USB-A		
Dimensions			
Enclosure (WxHxD)	19" x 3U x 609 mm (24")		
Total (WxHxD)	483 x 133 x 714 mm (19" x 5.2" x 28.1")		
Weight	≈ 30 kg (66.1 lb)	≈ 30 kg (66.1 lb)	≈ 30 kg (66.1 lb)
Article number ⁽³⁾	06230365	06230366	06230367

(1 Related to the nominal values, the accuracy defines the maximum deviation between an adjusted values and the true (actual) value

(2 For technical specifications of the analog interface see „3.5.4.4 Analog interface specification“ on page 58

(3 Article number of the standard version, devices with options will have a different number

15 kW	Model 400 V		
	PSI 9750-60	PSI 91000-40	PSI 91500-30
AC Input			
Voltage (L-L)	340...460 V AC		
Connection	3ph,PE	3ph,PE	3ph,PE
Frequency	45 - 65 Hz	45 - 65 Hz	45 - 65 Hz
Fusing (internal)	6x T16 A	6x T16 A	6x T16 A
Leak current	< 3.5 mA	< 3.5 mA	< 3.5 mA
Power factor	> 0.99	> 0.99	> 0.99
DC Output			
Max. output voltage U_{Max}	750 V	1000 V	1500 V
Max. output current I_{Max}	60 A	40 A	30 A
Max. output power P_{Max}	15 kW	15 kW	15 kW
Overvoltage protection range	0...825 V	0...1100 V	0...1650 V
Overcurrent protection range	0...66 A	0...44 A	0...33 A
Overpower protection range	0...16.50 kW	0...16.50 kW	0...16.50 kW
Temperature coefficient for set values Δ/K	Voltage / current: 100 ppm		
Output capacitance (approx.)	310 μ F	133 μ F	84 μ F
Voltage regulation			
Adjustment range	0...765 V	0...1020 V	0...1530 V
Accuracy ⁽¹⁾ (at 23 \pm 5°C / 73 \pm 9°F)	< 0.1% U_{Max}	< 0.1% U_{Max}	< 0.1% U_{Max}
Line regulation at \pm 10% ΔU_{AC}	< 0.02% U_{Max}	< 0.02% U_{Max}	< 0.02% U_{Max}
Load regulation at 0...100% load	< 0.05% U_{Max}	< 0.05% U_{Max}	< 0.05% U_{Max}
Rise time 10...90% ΔU	Max. 30 ms	Max. 30 ms	Max. 30 ms
Transient time after load step	< 1.5 ms	< 1.5 ms	< 1.5 ms
Display: Resolution	See section „1.9.6.4. Resolution of the displayed values“		
Display: Accuracy ⁽⁴⁾	\leq 0.2% U_{Max}	\leq 0.2% U_{Max}	\leq 0.2% U_{Max}
Ripple ⁽²⁾	< 800 mV _{PP} < 200 mV _{RMS}	< 2000 mV _{PP} < 300 mV _{RMS}	< 2400 mV _{PP} < 400 mV _{RMS}
Remote sensing compensation	Max. 5% U_{Max}	Max. 5% U_{Max}	Max. 5% U_{Max}
Fall time at no load after switching DC output off	Down from 100% to <60 V: less than 10 s		
Current regulation			
Adjustment range	0...61.2 A	0...40.8 A	0...30.6 A
Accuracy ⁽¹⁾ (at 23 \pm 5°C / 73 \pm 9°F)	< 0.2% I_{Max}	< 0.2% I_{Max}	< 0.2% I_{Max}
Line regulation at \pm 10% ΔU_{AC}	< 0.05% I_{Max}	< 0.05% I_{Max}	< 0.05% I_{Max}
Load regulation at 0...100% ΔU_{OUT}	< 0.15% I_{Max}	< 0.15% I_{Max}	< 0.15% I_{Max}
Ripple ⁽²⁾	< 48 mA _{RMS}	< 10 mA _{RMS}	< 26 mA _{RMS}
Display: Resolution	See section „1.9.6.4. Resolution of the displayed values“		
Display: Accuracy ⁽⁴⁾	\leq 0.2% I_{Max}	\leq 0.2% I_{Max}	\leq 0.2% I_{Max}
Power regulation			
Adjustment range	0...15.3 kW	0...15.3 kW	0...15.3 kW
Accuracy ⁽¹⁾ (at 23 \pm 5°C / 73 \pm 9°F)	< 1% P_{Max}	< 1% P_{Max}	< 1% P_{Max}
Line regulation at \pm 10% ΔU_{AC}	< 0.05% P_{Max}	< 0.05% P_{Max}	< 0.05% P_{Max}
Load reg. at 10-90% ΔU_{OUT} * ΔI_{OUT}	< 0.75% P_{Max}	< 0.75% P_{Max}	< 0.75% P_{Max}
Display: Resolution	See section „1.9.6.4. Resolution of the displayed values“		
Display: Accuracy ⁽⁴⁾	\leq 0.85% P_{Max}	\leq 0.85% P_{Max}	\leq 0.85% P_{Max}
Efficiency ⁽³⁾	\approx 94%	\approx 94%	\approx 95%

(1) Related to the nominal values, the accuracy defines the maximum deviation between an adjusted values and the true (actual) value.
Example: a 80 V model has min. 0.1% voltage accuracy, that is 80 mV. When adjusting the voltage to 5 V, the actual value is allowed to differ max. 80 mV, which means it might be between 4.92 V and 5.08 V.
(2) RMS value: LF 0...300 kHz, PP value: HF 0...20MHz
(3) Typical value at 100% output voltage and 100% power
(4) The display error adds to the error of the related actual value on the DC output.

15 kW	Model 400 V		
	PSI 9750-60	PSI 91000-40	PSI 91500-30
Internal resistance regulation			
Adjustment range	0...375 Ω	0...810 Ω	0...1500 Ω
Accuracy ⁽¹⁾	≤2% of max. resistance ± 0.3% of rated current		
Display: Resolution	See section „1.9.6.4. Resolution of the displayed values“		
Analog interface ⁽²⁾			
Set value inputs	U, I, P, R		
Actual value output	U, I		
Control signals	DC on/off, remote control on/off, resistance mode on/off		
Status signals	CV, OVP, OT		
Galvanic isolation to the device	≤725 V DC	≤1800 V DC	≤1800 V DC
Sample rate of inputs & outputs	500 Hz		
Insulation			
Allowed float (potential shift) on the DC output:			
Negative output to PE Max.	±725 V DC	±1000V DC	±1000V DC
Positive output to PE Max.	±1000 V DC	±1500 V DC	±1800 V DC
AC input <-> PE	2.5 kV DC		
AC input <-> DC output	2.5 kV DC		
Miscellaneous			
Cooling	Temperature controlled fans, front inlet, rear exhaust		
Ambient temperature	0..50°C (32...122°F)		
Storage temperature	-20...70°C (-4...158°F)		
Humidity	< 80%, not condensing		
Standards	IEC 61010:2010 EMC TÜV approved acc. IEC 61000-6-2:2005 and IEC 61000-6-3:2006 Class B		
Overvoltage category	2		
Protection class	1		
Pollution degree	2		
Operational altitude	< 2000 m (1.242 mi)		
Digital interfaces			
Featured	1x USB-B for communication, 1x USB-A for functions, 1x GPIB (optional)		
Slot (standard version)	Optional: CANopen, Profibus, Profinet, RS232, CAN, Ethernet, ModBus TCP, Ether-CAT		
Galvanic isolation from device	≤725 V DC	≤1800 V DC	≤1800 V DC
Terminals			
Rear side	Share Bus, DC output, AC input, remote sensing, analog interface, USB-B, master-slave bus, Interface module slot		
Front side	USB-A		
Dimensions			
Enclosure (WxHxD)	19" x 3U x 609 mm (24")		
Total (WxHxD)	483 x 133 x 714 mm (19" x 5.2" x 28.1")		
Weight	≈ 30 kg (66.1 lb)	≈ 30 kg (66.1 lb)	≈ 30 kg (66.1 lb)
Article number ⁽³⁾	06230368	06230370	06230369

(1 Related to the nominal values, the accuracy defines the maximum deviation between an adjusted values and the true (actual) value

(2 For technical specifications of the analog interface see „3.5.4.4 Analog interface specification“ on page 58

(3 Article number of the standard version, devices with options will have a different number

1.8.4 Specific technical data (208 V AC models)

The 208 V models are derivations from the standard 400 V models, intended to be sold on the US or Japan market or places where 208 V three-phase supply is typical. They only differ in a few technical specifications, which are listed below. The remaining specifications are listed in 1.8.3. The differences basically lie in the AC supply, the depth and weight.

5 kW	Model 208 V				
	PSI 9080-170	PSI 9200-70	PSI 9360-40	PSI 9500-30	PSI 9750-20
AC supply					
Voltage (L-L)	208 VAC, ± 10%				
Connection	2ph + PE				
Phase current	Max. 32 A (see 2.3.4.1)				
Dimensions					
Enclosure (WxHxD)	19" x 3U x 682 mm (26.8")				
Total (WxHxD)	483 x 133 x 787 mm (19" x 5.2" x 31")				
Weight	≈17 kg (37.5 lb)	≈17 kg (37.5 lb)	≈17 kg (37.5 lb)	≈17 kg (37.5 lb)	≈17 kg (37.5 lb)
Article number	06238351	06238352	06238353	06238354	06238355

10 kW	Model 208 V					
	PSI 9080-340	PSI 9200-140	PSI 9360-80	PSI 9500-60	PSI 9750-40	PSI 91000-30
AC supply						
Voltage (L-L)	208 VAC, ± 10%					
Connection	3ph + PE					
Phase current	Max. 56 A (see 2.3.4.1)					
Dimensions						
Enclosure (WxHxD)	19" x 3U x 682 mm (26.8")					
Total (WxHxD)	483 x 133 x 787 mm (19" x 5.2" x 31")					
Weight	≈24 kg (52.9 lb)	≈24 kg (52.9 lb)	≈24 kg (52.9 lb)	≈24 kg (52.9 lb)	≈24 kg (52.9 lb)	≈24 kg (52.9 lb)
Article number	06238357	06238358	06238359	06238360	06238361	06238362

15 kW	Model 208 V			
	PSI 9080-510	PSI 9200-210	PSI 9360-120	PSI 9500-90
AC supply				
Voltage (L-L)	208 VAC, ± 10%			
Connection	3ph + PE			
Phase current	Max. 56 A (see 2.3.4.1)			
Dimensions				
Enclosure (WxHxD)	19" x 3U x 682 mm (26.8")			
Total (WxHxD)	483 x 133 x 787 mm (19" x 5.2" x 31")			
Weight	≈ 30 kg (66.1 lb)	≈ 30 kg (66.1 lb)	≈ 30 kg (66.1 lb)	≈ 30 kg (66.1 lb)
Article number	06238364	06238365	06238366	06238367

15 kW	Model 208 V		
	PSI 9750-60	PSI 91000-40	PSI 91500-30
AC supply			
Voltage (L-L)	208 VAC, ± 10%		
Connection	3ph + PE		
Phase current	Max. 56 A (see 2.3.4.1)		
Dimensions			
Enclosure (WxHxD)	19" x 3U x 682 mm (26.8")		
Total (WxHxD)	483 x 133 x 787 mm (19" x 5.2" x 31")		
Weight	≈ 30 kg (66.1 lb)	≈ 30 kg (66.1 lb)	≈ 30 kg (66.1 lb)
Article number	06238368	06238370	06238369

1.8.5 Views

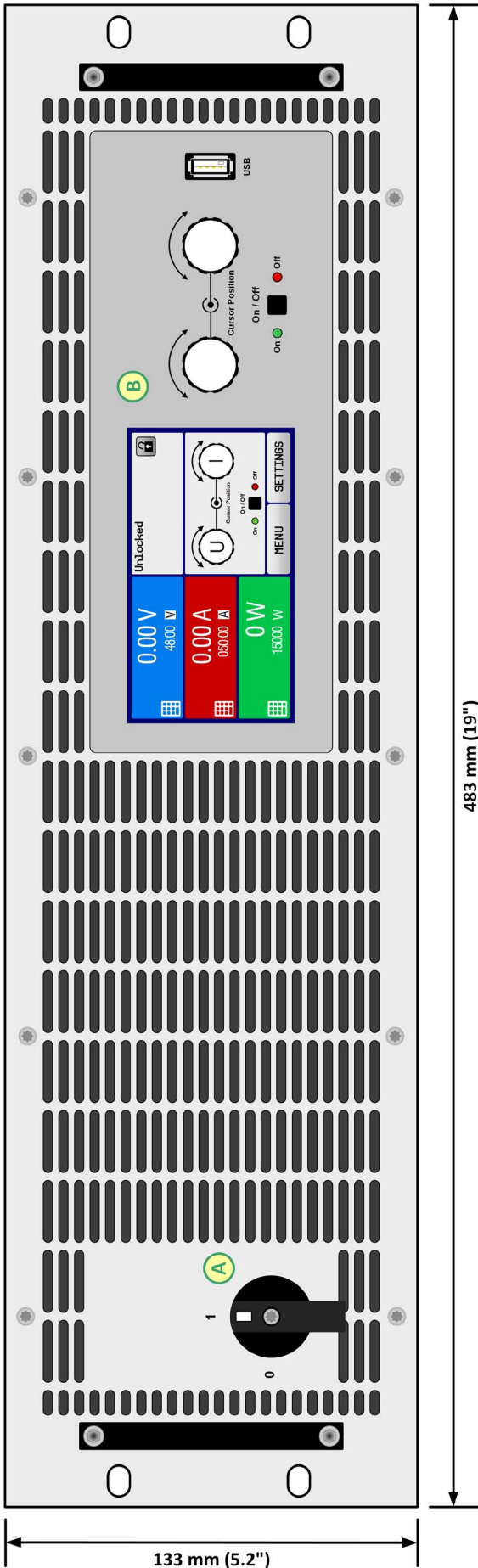

Figure 1 - Front view

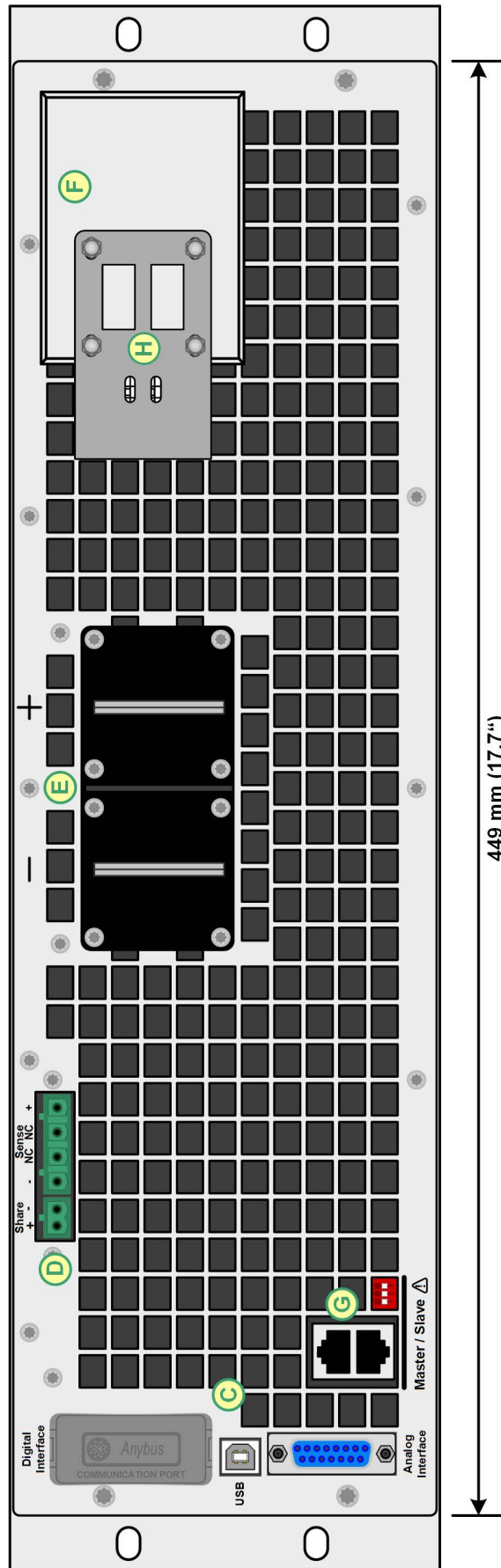

Figure 2 - Rear view (standard version)

- A - Power switch
- B - Control panel
- C - Control interfaces (digital, analog)
- D - Share Bus and remote sensing connection
- E - DC output (view shows terminal type 1)
- F - AC input connection (EU model shown)
- G - Master-Slave ports
- H - Plug fixture & strain relief

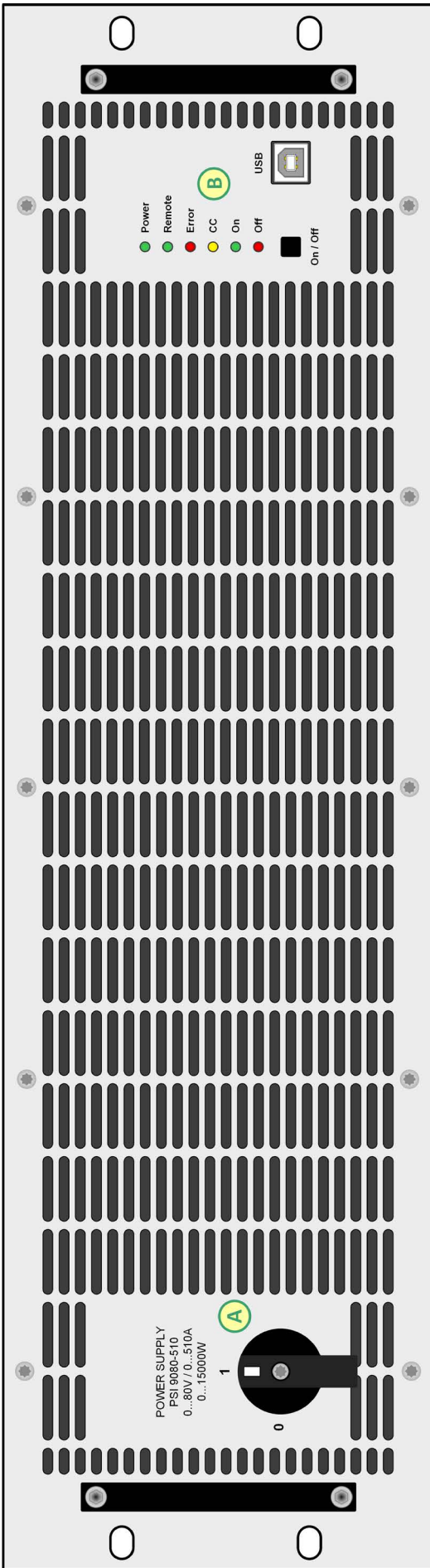

Figure 3 - Front view (PSI 9000 Slave)

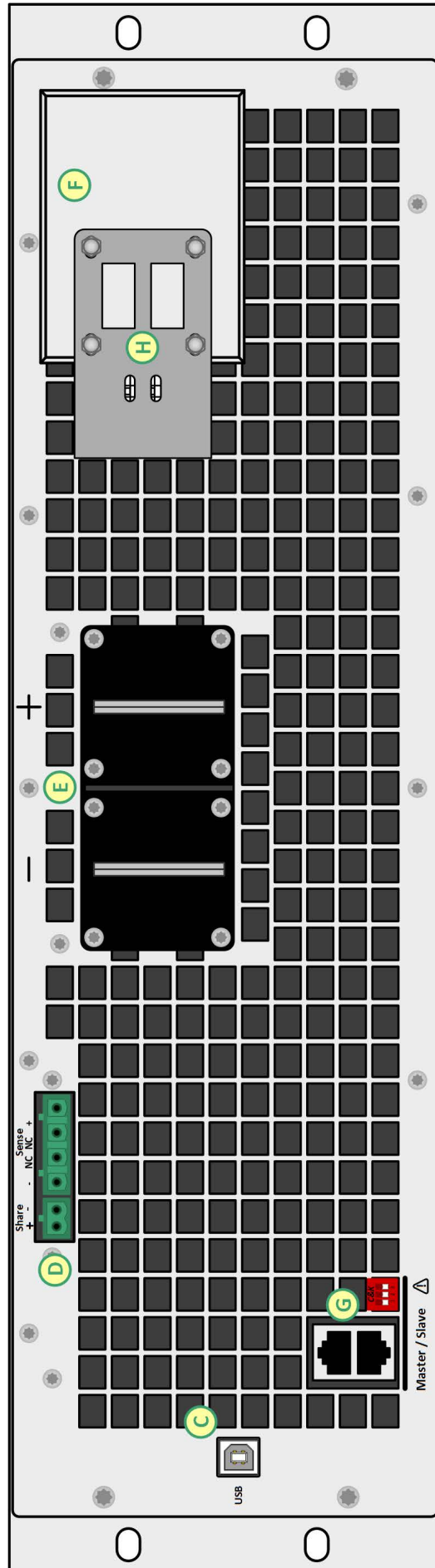

Figure 4 - Rear view (PSI 9000 Slave)

- A - Power switch
- B - Control panel
- C - USB interface
- D - Share Bus and remote sensing connection
- E - DC output
- F - AC input filter
- G - Master-Slave ports
- H - Plug fixture & strain relief

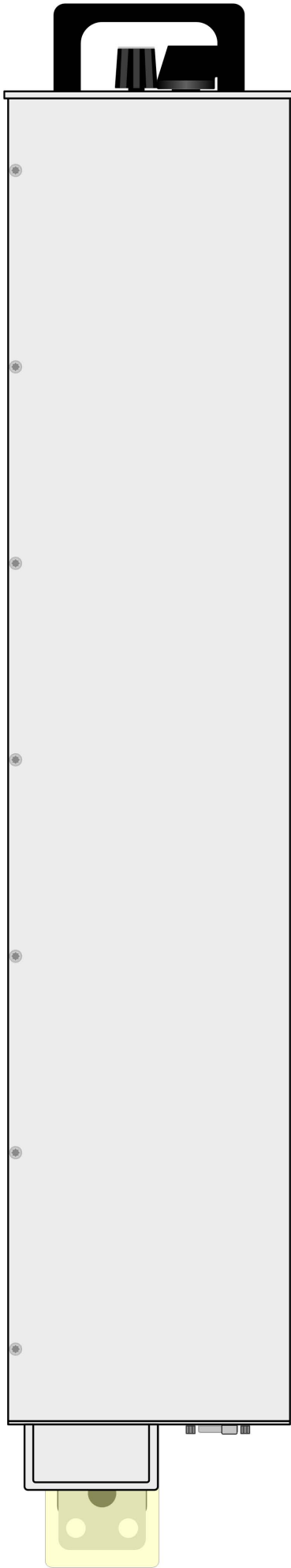
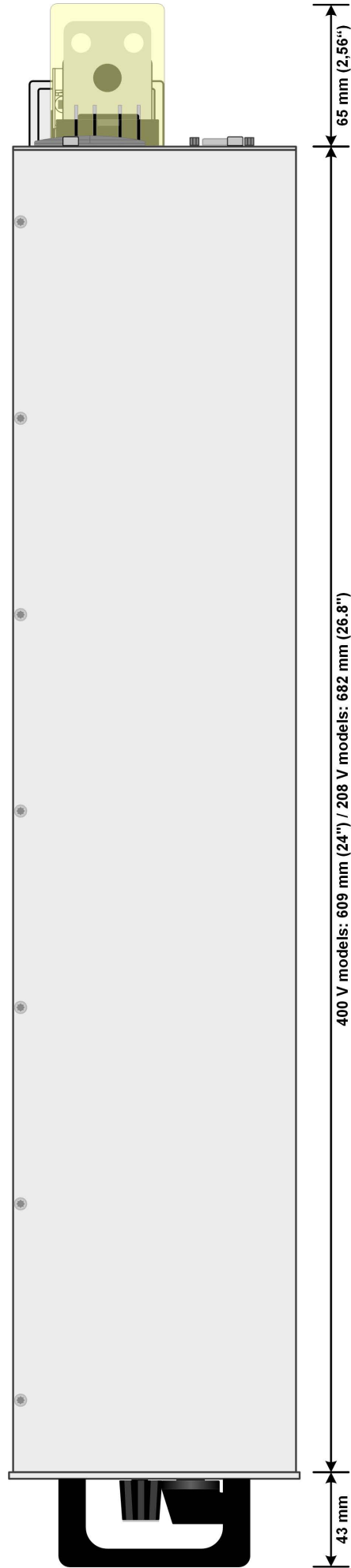

Figure 5 - Side view (left)



400 V models: 609 mm (24") / 208 V models: 682 mm (26.8")

43 mm (1,70")

Figure 6 - Side view (right)

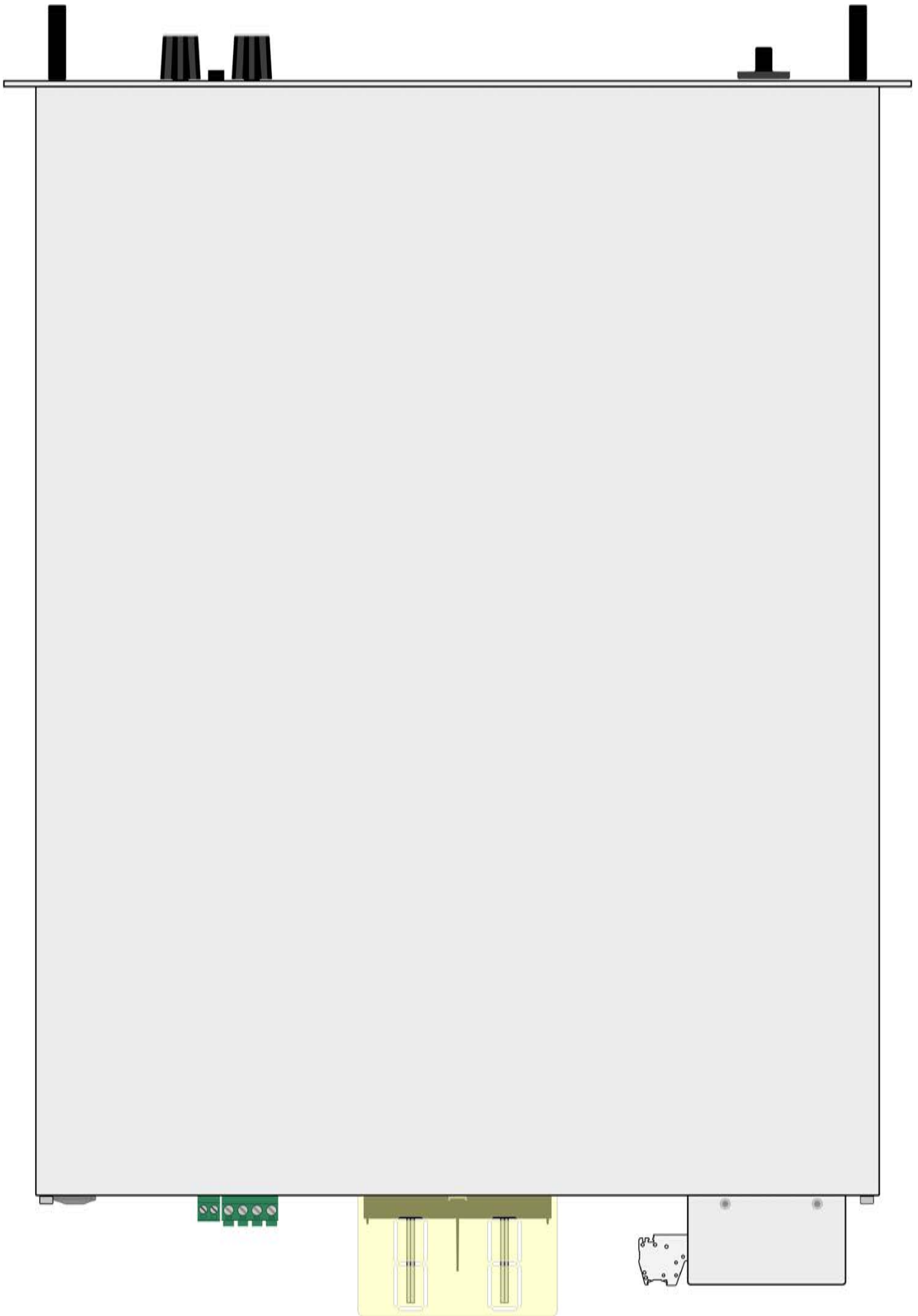

Figure 7 - View from above (EU model shown)

1.8.6 Control elements

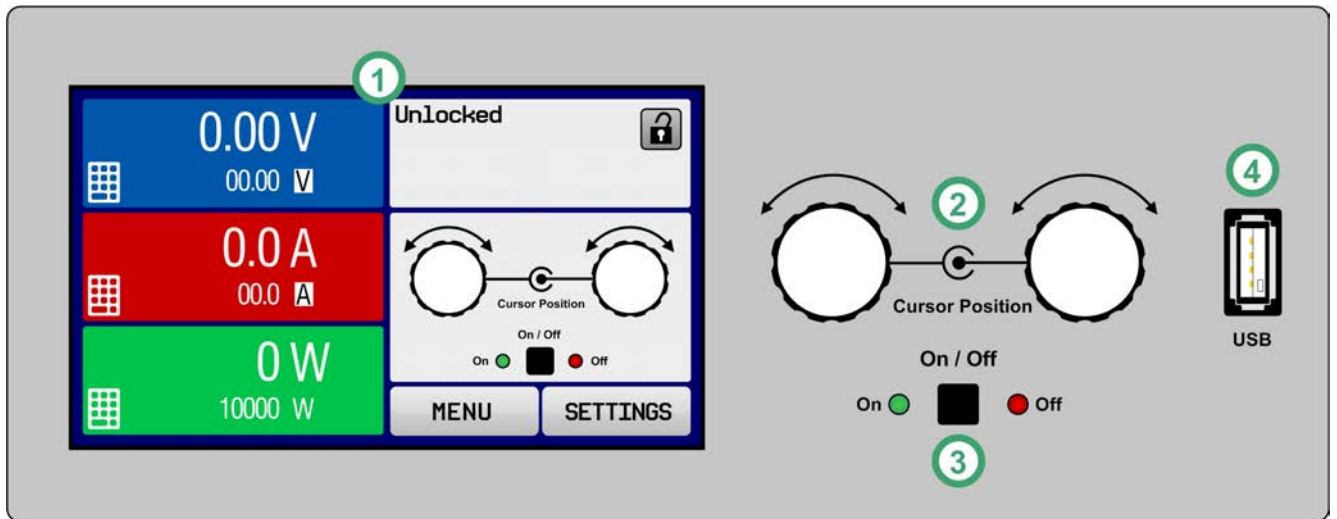

Figure 8- Control Panel

Overview of the elements on the control panel

For a detailed description see section „1.9.6. The control panel (HMI)“.

<p>(1)</p>	<p>Touchscreen display Used for selection of set values, menus and settings, as well as display of actual values and status. The touchscreen can be operated with the fingers or with a stylus.</p>
<p>(2)</p>	<p>Rotary knob with push button function Left knob (turn): adjusting the voltage set value, or setting the parameter values in the menu. Left knob (push): selection of the decimal position to be changed (cursor) in the current value selection. Right knob (turn): adjusting the current, power or resistance set value, or setting parameter values in the menu. Right knob (push): selection of the decimal position to be changed (cursor) in the current value selection.</p>
<p>(3)</p>	<p>On/Off Button for DC output Used to toggle the DC output between on and off, also used to start a function run. The LEDs “On” and “Off” indicate the state of the DC output, no matter if the device is manually controlled or remotely</p>
<p>(4)</p>	<p>USB-A port For the connection of standard USB sticks. See section „1.9.6.5. USB port (front side)“ for more details.</p>

1.9 Construction and function

1.9.1 General description

The electronic high performance power supplies of the PSI 9000 3U series are especially suitable for test systems and industrial controls due to their compact construction in a 19" enclosure with 3 height units (3U). Apart from basic functions of power supplies, set point curves can be generated in the integrated function generator (sine, rectangular, triangular and other curve types). Arbitrary generator curves (100 points) can be saved to and loaded from an USB stick.

For remote control using a PC or PLC the devices are provided as standard with an USB port on the back side as well as a galvanically isolated analog interface.

Via optional plug-in modules other digital interfaces such as Ethernet, RS232, Profibus, ProfiNet, ModBus TCP, CAN, EtherCAT or CANopen can be added. These enable the devices to be connected to standard industrial buses simply by changing or adding a small module. The configuration, if necessary at all, is simple.

In addition, the devices offer as standard the possibility for parallel connection in Share bus operation for constant current sharing plus a genuine master-slave connection with totaling of the slave units' values is also provided as standard. Operating in this way allows up to 16 units to be combined to a single system with a total power of up to 240 kW.

All models are controlled by microprocessors. These enable an exact and fast measurement and display of actual values.

1.9.2 Block diagram

The block diagram illustrates the main components inside the device and their relationships.

There are digital, microprocessor controlled components (KE, DR, HMI), which can be target of firmware updates.

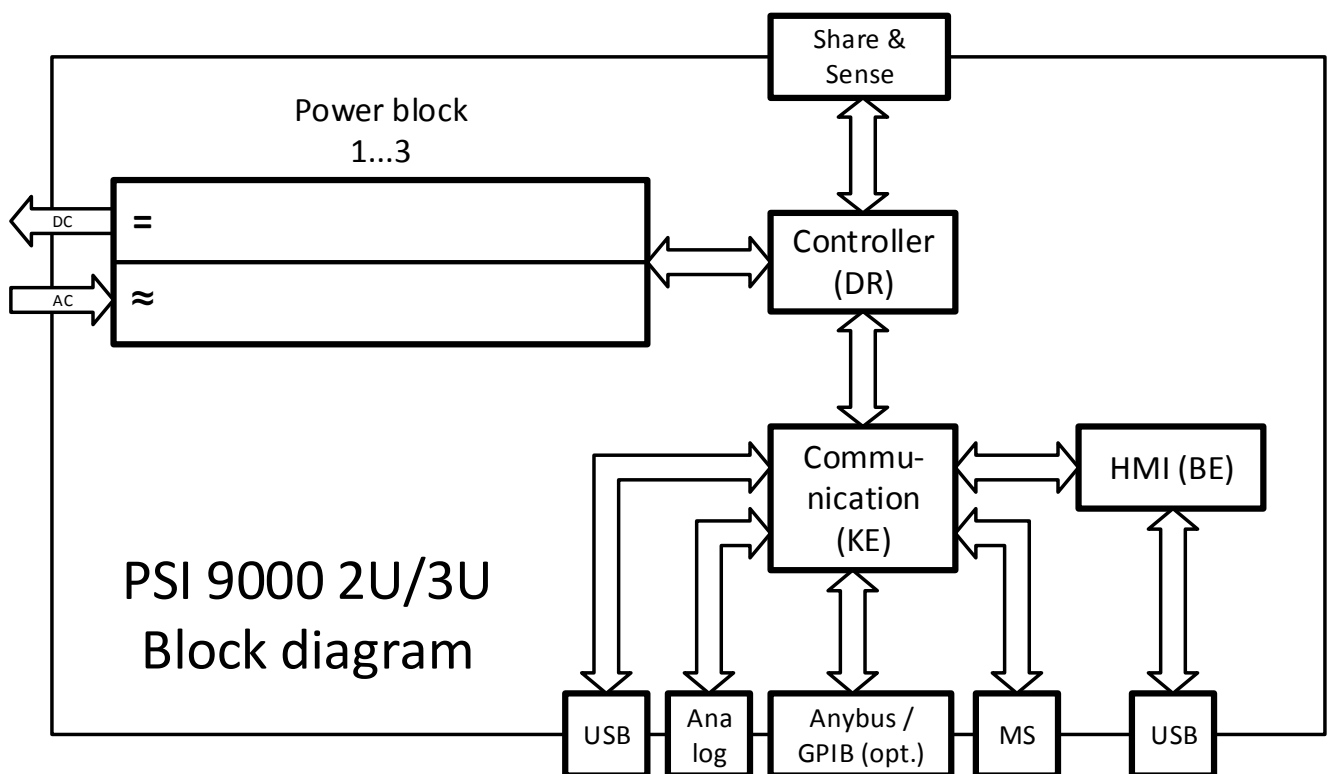

1.9.3 Scope of delivery

- 1 x Power supply device
- 1 x Share Bus plug
- 1 x Remote sensing plug
- 1 x 1.8 m USB cable
- 1 x Set of DC terminal covers
- 1 x Share/Sense terminal cover (only with models from 750 V)
- 1 x USB stick with documentation and software
- 1 x AC connector plug (clamp type)
- 1 x Set for strain relief (premounted)

1.9.4 Accessories

For these devices the following accessories are available:

Digital interface modules IF-AB	Pluggable and retrofittable digital interface modules for RS232, CANopen, Ethernet, Profibus, ProfiNet, ModBus TCP, EtherCAT or CAN are available. Details about the interface modules and the programming of the device using those interfaces can be found in separate documentation. It's usually available on the USB stick which is included with the device, or as PDF download on our website.
--	---

1.9.5 Options

These options are usually ordered along with the device, as they are permanently built in or preconfigured during the manufacturing process.

POWER RACKS 19"-rack	Racks in various configurations up to 42U as parallel systems are available, or mixed with electronic load devices to create test systems. Further information in our product catalogue, on our website or upon request																					
HS „High-Speed Ramping“	Increased output voltage dynamics through reduced output capacity. NOTE: other output values, as well as ripple also increase. This is a permanent feature which can't be switched off.																					
3W GPIB interface	Replaces the standard slot for pluggable interface modules by a rigidly installed GPIB port. This option can be retrofitted upon request. The device will keep the USB and analog interfaces. Via the GPIB port only SCPI commands are supported.																					
PSI 9000 SLAVE Additional slave units	These slave units are intended to extend the power of specific standard models of series PSI 9000 3U. They don't feature an HMI and are intended to only run being controlled by the master. The slave units can be ordered by their article number and retrofitted on location. A patch cable for master-slave bus connection of the additional slave is included. Following slave models are available: <table border="1" style="margin-top: 10px;"> <thead> <tr> <th>Model</th> <th>Article number</th> <th>Can be used to extend</th> </tr> </thead> <tbody> <tr> <td>PSI 9080-510 3U Slave</td> <td>06290364</td> <td>PSI 9080-510 3U</td> </tr> <tr> <td>PSI 9200-210 3U Slave</td> <td>06290365</td> <td>PSI 9200-210 3U</td> </tr> <tr> <td>PSI 9360-120 3U Slave</td> <td>06290366</td> <td>PSI 9360-120 3U</td> </tr> <tr> <td>PSI 9500-90 3U Slave</td> <td>06290367</td> <td>PSI 9500-90 3U</td> </tr> <tr> <td>PSI 9750-60 3U Slave</td> <td>06290368</td> <td>PSI 9750-60 3U</td> </tr> <tr> <td>PSI 91500-30 3U Slave</td> <td>06290369</td> <td>PSI 91500-30 3U</td> </tr> </tbody> </table>	Model	Article number	Can be used to extend	PSI 9080-510 3U Slave	06290364	PSI 9080-510 3U	PSI 9200-210 3U Slave	06290365	PSI 9200-210 3U	PSI 9360-120 3U Slave	06290366	PSI 9360-120 3U	PSI 9500-90 3U Slave	06290367	PSI 9500-90 3U	PSI 9750-60 3U Slave	06290368	PSI 9750-60 3U	PSI 91500-30 3U Slave	06290369	PSI 91500-30 3U
Model	Article number	Can be used to extend																				
PSI 9080-510 3U Slave	06290364	PSI 9080-510 3U																				
PSI 9200-210 3U Slave	06290365	PSI 9200-210 3U																				
PSI 9360-120 3U Slave	06290366	PSI 9360-120 3U																				
PSI 9500-90 3U Slave	06290367	PSI 9500-90 3U																				
PSI 9750-60 3U Slave	06290368	PSI 9750-60 3U																				
PSI 91500-30 3U Slave	06290369	PSI 91500-30 3U																				

1.9.6 The control panel (HMI)

The HMI (Human Machine Interface) consists of a display with touchscreen, two rotary knobs, a pushbutton and an USB port.

1.9.6.1 Touchscreen display

The graphic touchscreen display is divided into a number of areas. The complete display is touch sensitive and can be operated by finger or stylus to control the equipment.

In normal operation the left hand side is used to show actual values and set values and the right hand side is used to display status information:

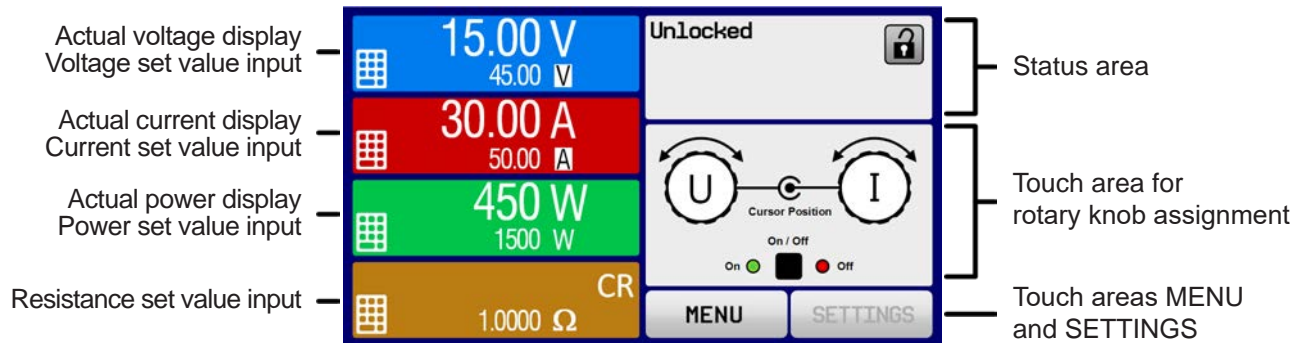

Touch areas may be enabled or disabled:



MENU

Black text or symbol = Enabled

SETTINGS

Grey text or symbol = Disabled

This applies to all touch areas on the main screen and all menu pages..

• Actual / set values area (left hand side)

In normal operation the DC output values (large numbers) and set values (small numbers) for voltage, current and power are displayed. Resistance set value of the variable internal resistance is only displayed by active resistance mode.

When the DC output is switched on, the actual regulation mode, **CV**, **CC**, **CP** or **CR** is displayed next to the corresponding actual values, as shown in the figure above.

The set values can be adjusted with the rotary knobs next to the display screen or can be entered directly via the touchscreen. When adjusting with the knobs, pushing the knob will select the digit to be changed. Logically, the values are increased by clockwise turning and decreased by anti-clockwise turning.



General display and setting ranges:

Display	Unit	Range	Description
Actual voltage	V	0-125% U_{Nom}	Actual values of DC output voltage
Set value of voltage ⁽¹⁾	V	0-102% U_{Nom}	Set value for limiting the DC output voltage
Actual current	A	0.2-125% I_{Nom}	Actual value of DC output current
Set value of current ⁽¹⁾	A	0-102% I_{Nom}	Set value for limiting the DC output current
Actual power	W, kW	0-125% P_{Nom}	Actual value of output power, $P = U * I$
Set value of power ⁽¹⁾	W, kW	0-102% P_{Nom}	Set value for limiting DC output power
Set value of internal resistance ⁽¹⁾	Ω	0-100% R_{Max}	Set value for the simulated internal resistance
Adjustment limits	ditto	0-102% nom	U-max, I-min etc., related to the physical values
Protection settings	ditto	0-110% nom	OVP, OCP etc., related to the physical values

⁽¹⁾ Valid also for values related to these physical quantities, such as OVD for voltage and UCD for current

• Status display (upper right)

This area displays various status texts and symbols:

Display	Description
Locked	The HMI is locked
Unlocked	The HMI is unlocked
Remote:	The device is under remote control from....
Analogthe built-in analog interface
USB & othersthe built-in USB port or a plug in interface module
Local	The device has been locked by the user explicitly against remote control
Alarm:	Alarm condition which has not been acknowledged or still exists.
Event:	A user defined event has occurred which isn't yet acknowledged.
Master	Master-slave mode activated, device is master
Slave	Master-slave mode activated, device is slave
Function:	Function generator activated, function loaded
 / 	Data logging to USB stick active or failed

• Area for assigning the rotary knobs

The two rotary knobs next to the display screen can be assigned to various functions. This area shows the actual assignments. These can be changed by tapping this area, as long as it's not locked. The display changes to:

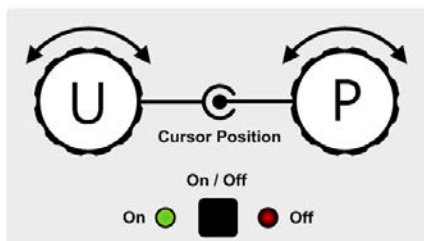

The physical quantities on the depiction of the knob shows the current assignment. With a power supply, the left knob is always assigned to the voltage U, while the right knob can be switched by tapping the depiction.

The area will then show the assignment:

U I

Left rotary knob: voltage
Right rotary knob: current

U P

Left rotary knob: voltage
Right rotary knob: power

U R

Left rotary knob: voltage
Right rotary knob: resistance

The other set values can't be adjusted via the rotary knobs, unless the assignment is changed. However, values can be entered directly with a ten-key pad by tapping on the small icon . Alternatively to the knob depiction, the assignment can also be changed by tapping the colored set value areas.

1.9.6.2 Rotary knobs



As long as the device is in manual operation, the two rotary knobs are used to adjust set values, as well as setting the parameters in SETTINGS and MENU. For a detailed description of the individual functions see section „3.4. Manual operation“.

1.9.6.3 Pushbutton function of the knobs

The rotary knobs also have a pushbutton function which is used in all value adjustment to move the cursor by rotation as shown:



1.9.6.4 Resolution of the displayed values

In the display, set values can be adjusted in fixed increments. The number of decimal places depends on the device model. The values have 3 to 5 digits. Actual and set values always have the same number of digits.

Adjustment resolution and number of digits of set values in the display:

Voltage, OVP, UVD, OVD, U-min, U-max			Current, OCP, UCD, OCD, I-min, I-max			Power, OPP, OPD, P-max			Resistance, R-max		
Nominal	Digits	Min. increment	Nominal*	Digits	Min. increment	Nominal*	Digits	Min. increment	Nominal	Digits	Min. increment
≤80 V	4	0.01 V	20 A	5	0.001 A	≤ 6600 W	4	1 W	≤ 7 Ω	5	0.0001 Ω
200 V	5	0.01 V	30 A - 90 A	4	0.01 A	≥ 10000 W	5	1 W	14 Ω - 90 Ω	5	0.001 Ω
360 V	4	0.1 V	120 A - 210 A	5	0.01 A	MS < 10kW	3	0.1 kW	135 Ω - 526 Ω	5	0.01 Ω
500 V	4	0.1 V	≥ 340 A	4	0.1 A	MS < 100kW	4	0.01 kW	≥ 1000 Ω	5	0.1 Ω
750 V	4	0.1 V	MS >1000 A	5	0.1 A	MS ≥ 100kW	4	0.1 kW			
≥1000 V	5	0.1 V									

* MS = master-slave

1.9.6.5 USB port (front side)

The frontal USB port, located to the right of the rotary knobs, is intended for the connection of standard USB sticks and can be used for loading or saving sequences for the arbitrary and the XY generator, as well as for recording measured data during running operation.

USB 2.0 sticks are widely accepted. USB 3.0 sticks work, but not from all manufacturers. The stick must be **FAT32** formatted and should have a **maximum capacity of 32 GB**. All supported files must be held in a designated folder in the root path of the USB drive in order to be found. This folder must be named **HMI_FILES**, such that a PC would recognize the path G:\HMI_FILES if the drive were to be assigned the letter G.

The control panel of the device can read the following file types and names from a stick:

wave_u<your_text>.csv wave_i<your_text>.csv	Function generator for an arbitrary function on voltage (U) or current (I) The name must begin with <i>wave_u</i> / <i>wave_i</i> , the rest is user defined.
profile_<your_text>.csv	Previously saved user profile. A max. of 10 files to select from is shown when loading a user profile.
iu<your_text>.csv ui<your_text>.csv	IU or UI table for the XY function generator. The name must begin with <i>iu</i> or <i>ui</i> , the rest can be user defined.
pv<your_text>.csv fc<your_text>.csv	PV or FC table for the XY function generator. The name must begin with <i>pv</i> or <i>fc</i> , the rest can be user defined.
pv_day_et_<your_text>.csv pv_day_ui_<your_text>.csv	Day trend data file to load for the simulation modes DAY I/T and DAY U/I of the extended PV function. See section „3.10.15.5. Day trend“ for details.

The control panel of the device can save the following file types and names to an USB stick:

usb_log_<nr>.csv	File with log data recorded during normal operation in all modes. The file layout is identical to the those generated from the Logging feature in EA Power Control. The <nr> field in the file name is automatically counted up if equally named files already exist in the folder.
profile_<nr>.csv	Saved user profile. The number in the file name is a counter and not related to the actual user profile number in the HMI. A max. of 10 files to select from is shown when loading a user profile.
pv<nr>.csv	PF function table data, as calculated by the device. Can be loaded again.
fc<nr>.csv	FC function table data, as calculated by the device. Can be loaded again.
wave_u<nr>.csv wave_i<nr>.csv	Set point data (here: sequences) from arbitrary function generator of either voltage U or current I
pv_record_<nr>.csv	Data from the data recording option in the extended PV function according to EN 50530. See section „3.10.15.7. Data recording“ for details.

1.9.7 USB port type B (rear side)

The USB-B port on the back side of the device is provided for communication with the device and for firmware updates. The included USB cable can be used to connect the device to a PC (USB 2.0 or 3.0). The driver is delivered with the device and installs a virtual COM port. Details for remote control can be found on the web site of the manufacturer or on the included USB stick.

The device can be addressed via this port either using the international standard ModBus RTU protocol or by SCPI language. The device recognises the message protocol used automatically.

If remote control is in operation the USB port has no priority over either the interface module (see below) or the analog interface and can, therefore, only be used alternatively to these. However, monitoring is always available.

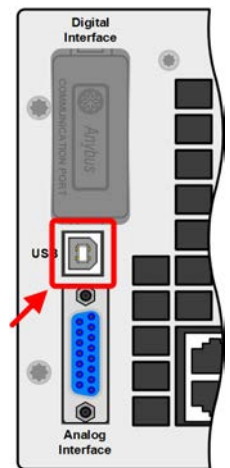

1.9.8 Interface module slot

This slot on the back side of the device (only with standard models, units with option 3W installed are different) is available for various modules of the IF-AB interface module series. The following options are available:

Article number	Name	Description
35400100	IF-AB-CANO	CANopen, 1x Sub-D 9pole male
35400101	IF-AB-RS232	RS 232, 1x Sub-D 9pole male (null modem)
35400103	IF-AB-PBUS	Profibus DP-V1 Slave, 1x Sub-D 9pole female
35400104	IF-AB-ETH1P	Ethernet, 1x RJ45
35400105	IF-AB-PNET1P	ProfiNET IO, 1x RJ45
35400107	IF-AB-MBUS1P	ModBus TCP, 1x RJ45
35400108	IF-AB-ETH2P	Ethernet, 2x RJ45
35400109	IF-AB-MBUS2P	ModBus TCP, 2x RJ45
35400110	IF-AB-PNET2P	ProfiNET IO, 2x RJ45
35400111	IF-AB-CAN	CAN 2.0 A / 2.0 B, 1x Sub-D 9-pole, male
35400112	IF-AB-ECT	EtherCAT, 1x RJ45

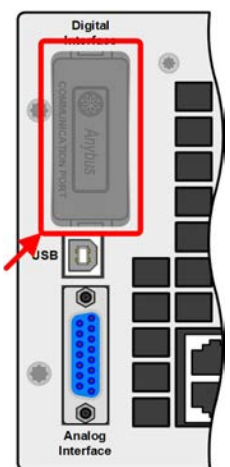

The modules are installed by the user and can be retrofitted without problem. A firmware update of the device may be necessary in order to recognize and support certain modules.

If remote control is in operation the interface module has no priority over either the USB port or the analog interface and can, therefore, only be used alternately to these. However, monitoring is always available.



Switch off device before adding or removing modules!

1.9.9 Analog interface

This 15-pole Sub-D socket on the back side of the device is provided for remote control of the device via analog or digital signals.

If remote control is in operation this analog interface can only be used alternately to the digital interface. However, monitoring is always available.

The input voltage range of the set values and the output voltage range of the monitor values, as well as reference voltage level can be switched in the settings menu of the device between 0-5 V and 0-10 V, in each case for 0-100%.

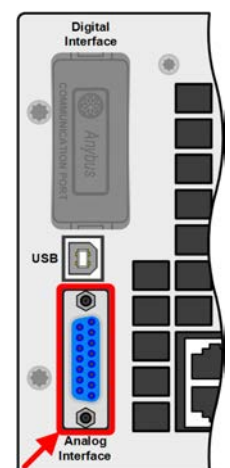

1.9.10 “Share” connector

The 2-pole Phoenix socket (“Share”) on the back side of the device is provided for connection to equally named sockets on compatible power supplies series to achieve a balanced load current distribution during parallel connection. The socket is also used to connect the power supply to compatible electronic loads, in order to build a two-quadrants operation setup. Following power supply and electronic load series are compatible:

- PSI 9000 2U - 24U / PSI 9000 WR
- ELR 9000 / ELR 9000 HP
- EL 9000 B / EL 9000 B HP / EL 9000 B 2Q
- PSE 9000
- PS 9000 1U / 2U / 3U *

* From hardware revision 2, see type label (in case it does not show “Revision” on type label, it’s revision 1)

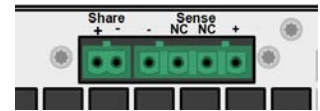

1.9.11 “Sense” connector (remote sensing)

In order to compensate for voltage drops along the DC cables to the load, the Sense input can be connected to the load. The maximum possible compensation is given in the technical specifications.

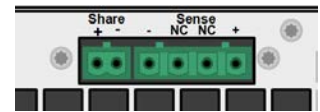

In order to ensure safety and to comply to international directives, insulation of high voltage models, i. e. such with a nominal voltage of 500 V or higher, is ensured by using only the two outer pins of the 4-pole terminal. The inner two pins, marked with NC, must remain unconnected.



Models rated with 750 V or higher are delivered with an extra cover for the Sense and Share connector, which is mounted using the screws to the left and right of the connectors. These screws must always be put and tightened, as they ensure PE connection for EMC filtering parts.

1.9.12 Master-Slave bus

A further port is provided on the back side of the device, comprising two RJ45 sockets, which enables multiple identical devices to be connected via a digital bus (RS485) to create a master-slave system. Connection is made using standard CAT5 cables. These can theoretically have a length of up to 1200 m, but it’s recommended to keep the connections as short as possible.

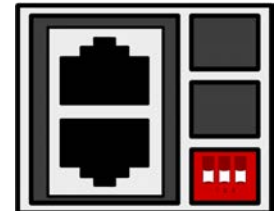

1.9.13 GPIB port (optional)

The optional GPIB connector, which is available with option 3W, will replace the module slot of standard version devices. The device then offers a three-way interface with GPIB, USB and analog.

The connection to a PC or other GPIB port is done with standard GPIB cables from stock, which can have straight or 90° connectors.

When using cable with 90° connectors, the USB port will be inaccessible.

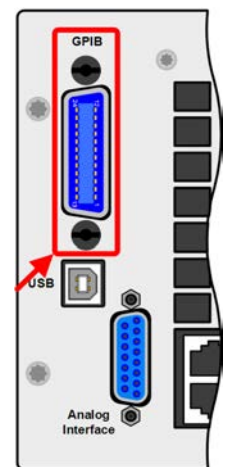

2. Installation & commissioning

2.1 Transport and storage

2.1.1 Transport



- The handles on the front side of the device are **not** for carrying!
- Because of its weight, transport by hand should be avoided where possible. If unavoidable then only the housing should be held and not on the exterior parts (handles, DC output terminal, rotary knobs).
- Do not transport when switched on or connected!
- When relocating the equipment use of the original packing is recommended
- The device should always be carried and mounted horizontally
- Use suitable safety clothing, especially safety shoes, when carrying the equipment, as due to its weight a fall can have serious consequences.

2.1.2 Packaging

It's recommended to keep the complete transport packaging for the lifetime of the device for relocation or return to the manufacturer for repair. Otherwise the packaging should be disposed of in an environmentally friendly way.

2.1.3 Storage

In case of long term storage of the equipment it's recommended to use the original packaging or similar. Storage must be in dry rooms, if possible in sealed packaging, to avoid corrosion, especially internal, through humidity.

2.2 Unpacking and visual check

After every transport, with or without packaging, or before commissioning, the equipment should be visually inspected for damage and completeness using the delivery note and/or parts list (see section „1.9.3. *Scope of delivery*“). An obviously damaged device (e.g. loose parts inside, damage outside) must under no circumstances be put in operation.

2.3 Installation

2.3.1 Safety procedures before installation and use



- The device may, according to model, have a considerable weight. Therefore the proposed location of the equipment (table, cabinet, shelf, 19" rack) must be able to support the weight without restriction.
- When using a 19" rack, rails suitable for the width of the housing and the weight of the device are to be used (see „1.8.3. *Specific technical data (400 V AC models)*“ resp. „1.8.4. *Specific technical data (208 V AC models)*“)
- Before connecting to the mains ensure that the supply voltage is as shown on the product label. Overvoltage on the AC supply can cause equipment damage.

2.3.2 Preparation

Mains connection for the PSI 9000 3U series is done via the included 5-pole plug on the back of the device. Wiring of the plug is at least 3 wire (L2+L3+PE) or, for some models, 4 wire (L1+L2+L3+PE) of suitable cross section and length. 5 wire cables with N conductor are also usable. For more section see „2.3.4. *Connection to AC supply*“.

Dimensioning of the DC wiring to the load/consumer has to reflect the following:



- The cable cross section should always be specified for at least the maximum current of the device.
- Continuous operation at the approved limit generates heat which must be removed, as well as voltage loss which depends on cable length and heating. To compensate for these the cable cross section should be increased and the cable length reduced.

2.3.3 Installing the device



- Select the location for the device so that the connection to the load is as short as possible.
- Leave sufficient space behind the equipment, minimum 30 cm, for ventilation.

A device in a 19" chassis will usually be mounted on suitable rails and installed in 19" racks or cabinets. The depth of the device and its weight must be taken into account. The handles on the front are for sliding in and out of the cabinet. Slots on the front plate are provided for fixing the device (fixing screws not included).

On some models the mounting brackets provided to fix the device in a 19" cabinet can be removed so that the device can be operated on any flat surface as a desk top device.

Acceptable and unacceptable installation positions:

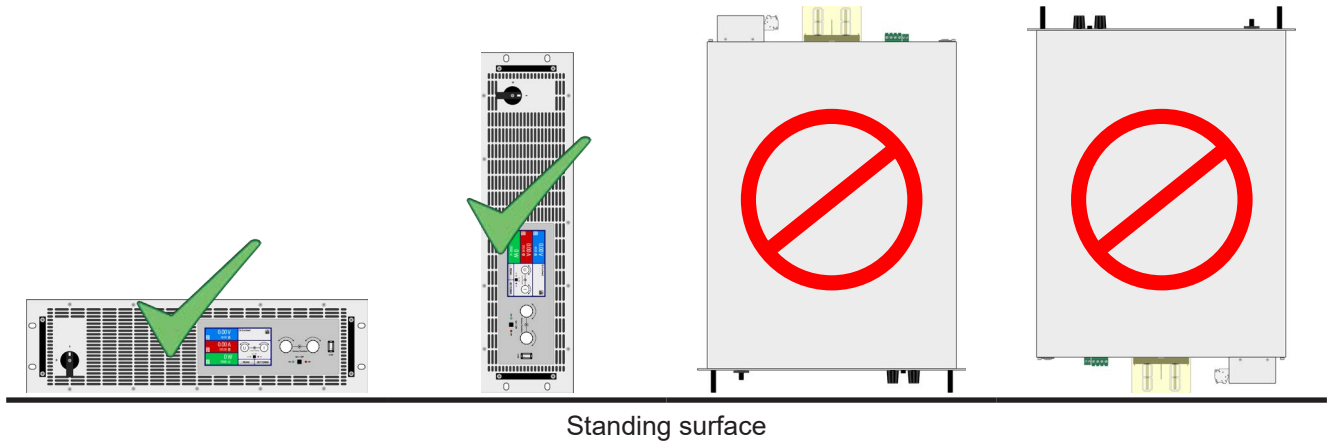

2.3.4 Connection to AC supply



- Connection to an AC mains supply may only be carried out by qualified personnel!
- Cable cross section must be suitable for the maximum input current of the device (see tables below)!
- Before plugging in the input plug ensure that the device is switched off by its mains switch!
- It's recommend to always connect all three phases, even if the device doesn't require them, because then no phase can be missing

2.3.4.1 Models for 400 V

The device is delivered with a 5-pole AC plug. Depending on model, the plug is connected to a 2-phase or 3-phase AC supply, according to the labelling on the plug. Required are following phases:

Nominal power	Inputs on AC plug	Supply type
3.3 kW / 5 kW	L2, L3, PE	Three-phase
≥6.6 kW	L1, L2, L3, PE	Three-phase



The PE conductor is imperative and must always be wired!

For the selection of a suitable cable **cross section** the rated AC current of the device and the cable length are decisive. Based on the connection of a **single unit** the table lists the maximum input current and recommended minimum cross section for each phase:

Nominal power	L1		L2		L3		PE
	∅	I _{max}	∅	I _{max}	∅	I _{max}	∅
3.3 kW	-	-	2.5 mm ²	11 A	2.5 mm ²	11 A	2.5 mm ²
5 kW	-	-	2.5 mm ²	16 A	2.5 mm ²	16 A	2.5 mm ²
6.6 kW	2.5 mm ²	19 A	2.5 mm ²	11 A	2.5 mm ²	11 A	2.5 mm ²
10 kW (except for 40 V models)	4 mm ²	28 A	4 mm ²	16 A	4 mm ²	16 A	4 mm ²
10 kW (40 V models)	2.5 mm ²	19 A	2.5 mm ²	19 A	2.5 mm ²	19 A	2.5 mm ²
15 kW	4 mm ²	28 A	4 mm ²	28 A	4 mm ²	28 A	4 mm ²

The included connection plug can receive crimped cable ends of up to 6 mm². The longer the connection cable, the higher the voltage loss due to the cable resistance. Therefore the mains cables should be kept as short as possible or have a bigger cross section. Cables with 4 or 5 conductors can be used. When using a cable with N conductor, it's allowed to clamp it into the spare pin of the AC plug.

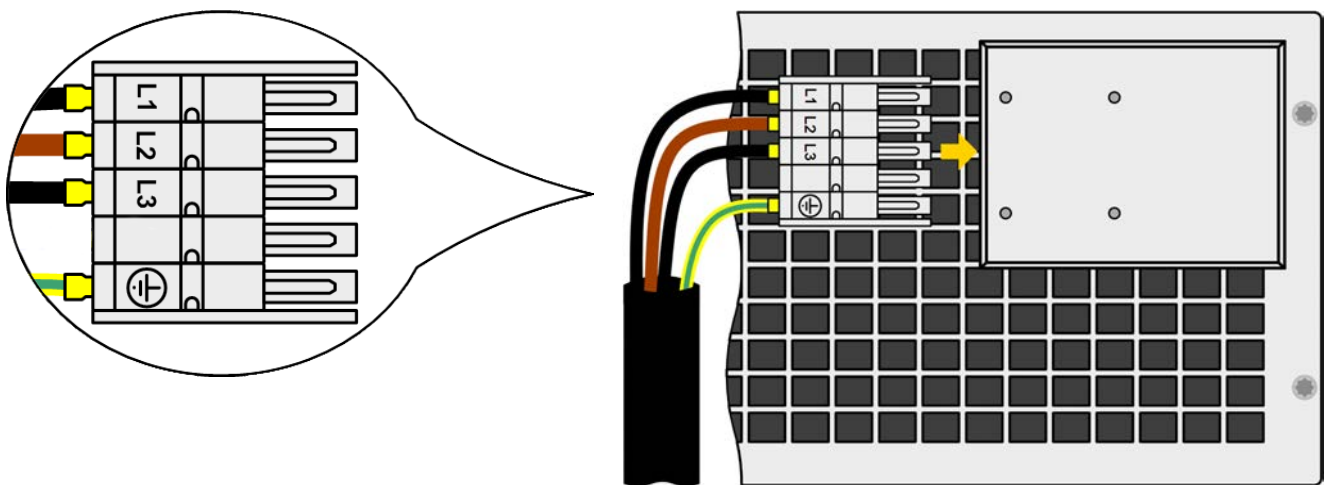

Figure 9 - Example for an AC cable with 4 conductors (cable not included in delivery)

2.3.4.2 Models for 208 V

The 208 V models are delivered with a 4-pole mains plug for higher currents. Depending on model, the device requires a supply with 2 or 3 phases and 208 V, which have to be wired according to the labelling on the plug. Phase requirement:

Nominal power	Inputs on AC plug	Supply type
5 kW	L2, L3, PE	Three-phase
≥10 kW	L1, L2, L3, PE	Three-phase

For the wiring **cross section**, the power of the device and the cable length are decisive. The table below shows the maximum output current for each phase, based on the connection of a **standalone unit**:

Nominal power	L1		L2		L3		PE
	∅	I _{max}	∅	I _{max}	∅	I _{max}	∅
5 kW	-	-	AWG 12	32 A	AWG 12	32 A	AWG 12
10 kW	AWG 8	56 A	AWG 8	32 A	AWG 8	32 A	AWG 8
15 kW	AWG 8	56 A	AWG 8	56 A	AWG 8	56 A	AWG 8

The included connection plug can receive lose/soldered cable ends of up to 16 mm² (AWG 6). The longer the connection cable, the higher the voltage loss due to the cable resistance. Therefore the mains cables should be kept as short as possible or use bigger cross section.

Connection schemes:

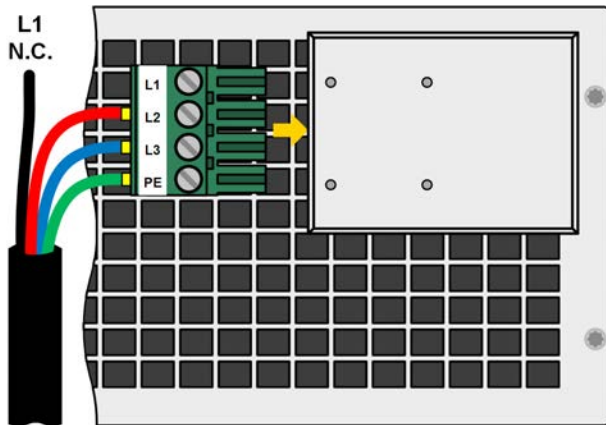

Figure 10 - L2+L3+PE connection scheme for 5 kW models

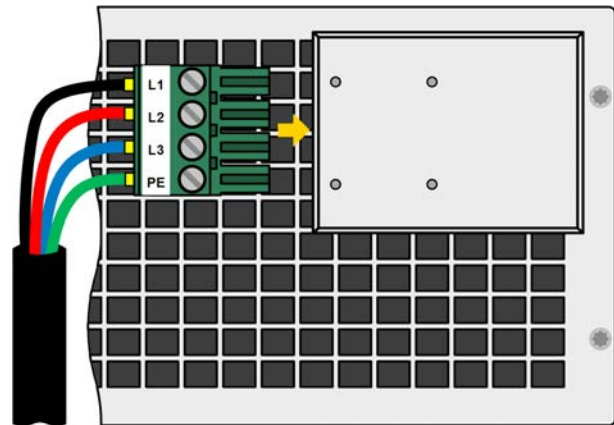

Figure 11 - Full connection scheme for 10 kW or higher models

2.3.4.3 Strain relief and plug fixture

There is a standard fixture mounted to the AC input connection block on the rear. It's used to prevent the AC plug from loosening and disconnecting due to vibrations or similar. The fixture is also used as strain relief.

Using the 4x M3 acorn nuts, it's recommend to mount the fixture to the AC filter block every time the AC plug has been plugged again.

It's furthermore recommended to install the strain relief by using suitable cable straps (not included), as depicted in the figure to the right.

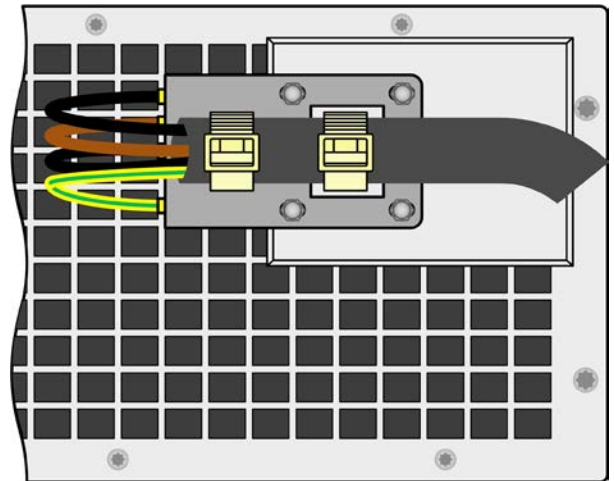

2.3.4.4 Connection variants

Depending on the max. power rating of a specific model, it requires two or three phases of a three-phase AC supply. In case **multiple units with 3.3 kW to 10 kW power rating** are connected to the same main terminal it's recommended to take care for balanced current distribution on the three phases. See table in 2.3.4 for the max. phase currents.

The **15 kW** models are an exception, because they already consume balanced current on all three phases. As long as only such models are installed, no unbalanced AC load is expected. Mixed systems with 15 kW and 10 kW models (note: the 10 kW model PSI 9040-510 3U is internally configured like a 15 kW) or models with lower power rating are not automatically balanced.

Suggestions to assign phases:

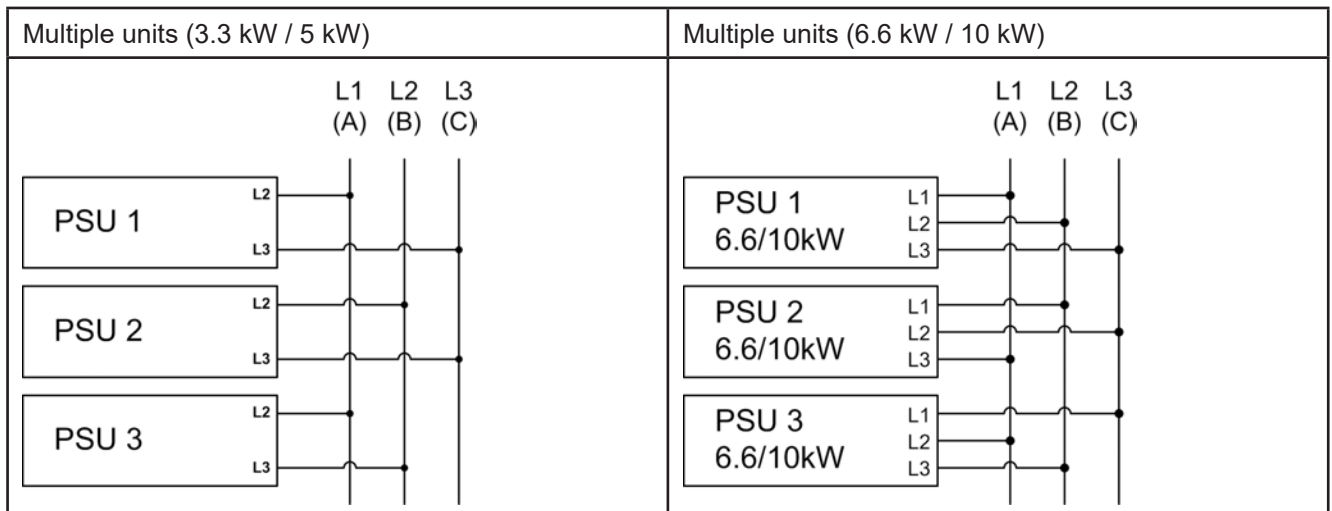
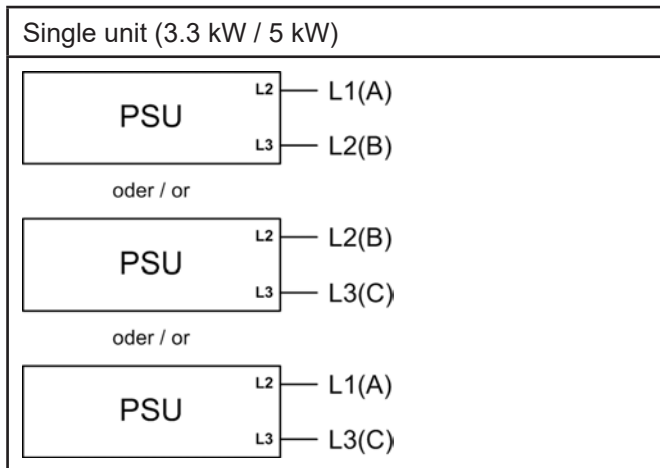

2.3.5 Connection to DC loads



- In the case of a device with a high nominal current and hence a thick and heavy DC connection cable it's necessary to take account of the weight of the cable and the strain imposed on the DC connection. Especially when mounted in a 19" cabinet or similar, where the cable hangs on the DC output, a strain reliever should be used.
- Connection to and operation with transformerless DC-AC inverters (for example solar inverters) is restricted, because the inverter can shift the potential of negative output (DC-) against PE (ground). Mind the max. allowed potential shift (see technical specifications)!

The DC load output is on the back side of the device and isn't protected by a fuse. The cross section of the connection cable is determined by the current consumption, cable length and ambient temperature.

For cables up to 1.5 m and average ambient temperature up to 50°C, we recommend:

up to 30 A :	6 mm ²	up to 70 A :	16 mm ²
up to 90 A :	25 mm ²	up to 140 A :	50 mm ²
up to 170 A :	70 mm ²	up to 210 A :	95 mm ²
up to 340 A :	2x 70 mm ²	up to 510 A :	2x 120 mm ²

per connection pole (multi-conductor, insulated, openly suspended). Single cables of, for example, 70 mm² may be replaced by e.g. 2x35 mm² etc. If the cables are long then the cross section must be increased to avoid voltage loss and overheating.

2.3.5.1 DC terminal types

The table below shows an overview of the various DC terminals. It's recommended that connection of load cables always utilises flexible cables with ring lugs.

Type 1: Models up to 360 V output voltage	Type 2: Models from 500 V output voltage
M8 bolt on a metal rail Recommendation: ring lug with a 8 mm hole	M6 bolt on a metal rail Recommendation: ring lug with a 6 mm hole

2.3.5.2 Cable lead and plastic cover

A plastic cover for contact protection is included for the DC terminal. It should always be installed. The cover for type 2 (see picture above) is fixed to the connector itself, for type 1 to the back of the device. Furthermore the cover for type 1 has break outs so that the supply cable can be laid in various directions.



The connection angle and the required bending radius for the DC cable must be taken into account when planning the depth of the complete device, especially when installing in a 19" cabinet or similar. For type 2 connectors only a horizontal lead can be used to allow for installation of the cover.

Examples of the type 1 terminal:

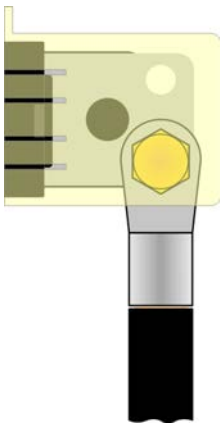

- 90° up or down
- space saving in depth
- no bending radius

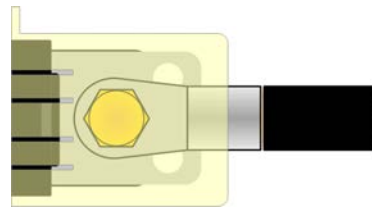

- horizontal lead
- space saving in height
- large bending radius

2.3.6 Grounding of the DC output

Grounding one of the DC output poles is allowed. Doing so results in a potential shift of the other pole against PE. Because of insulation, there is a max. allowed potential shift of the DC output poles, which also depends on the device model. Refer to „1.8.3. Specific technical data (400 V AC models)“ resp. „1.8.4. Specific technical data (208 V AC models)“ for details.

2.3.7 Connecting the analog interface

The 15-pole connector (Type: Sub-D, D-Sub) on the rear side is an analog interface. To connect this to a controlling hardware (PC, electronic circuit), a standard plug is necessary (not included in the scope of delivery). It's generally advisable to switch the device completely off before connecting or disconnecting this connector, but at least the DC output.



The analog interface is galvanically isolated from the device internally. Therefore do not connect any ground of the analog interface (AGND) to the DC minus output as this will cancel the galvanic isolation.

2.3.8 Connection of remote sense



Both pins „NC“ of the Sense connector must not be wired!



- Remote sensing is only effective during constant voltage operation (CV) and for other regulation modes the sense input should be disconnected, if possible, because connecting it generally increases the oscillation tendency
- The cross section of the sense cables is noncritical. Recommendation for cables up to 5 m: use at least 0.5 mm²
- Sense cables should be twisted and laid close to the DC cables to damp oscillation. If necessary, an additional capacitor should be installed at the load/consumer to eliminate oscillation
- The + sense cables must be connected to + on the load and - sense to - at the load, otherwise the sense input of the power supply can be damaged. For an example see *Figure 12* below.
- In master-slave operation, the remote sensing should be connected to the master unit only

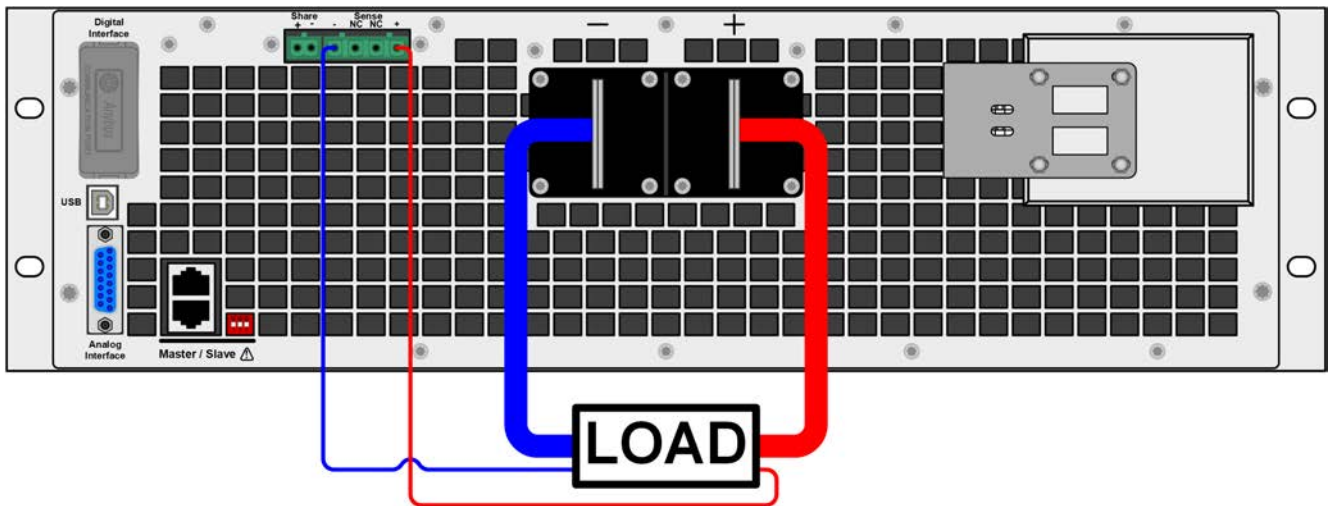

Figure 12 - Example for remote sensing wiring

2.3.9 Installation of an interface module

The optionally obtainable interface modules can be retrofitted by the user and are exchangeable with each other. The settings for the currently installed module vary and need to be checked and, if necessary, corrected on initial installation and after module exchange.



- Common ESD protection procedures apply when inserting or exchanging a module.
- The device must be switched off before insertion or removal of a module
- Never insert any other hardware other than an interface module into the slot
- If no module is in use it's recommended that the slot cover is mounted in order to avoid internal dirtying of the device and changes in the air flow.

Installation steps:

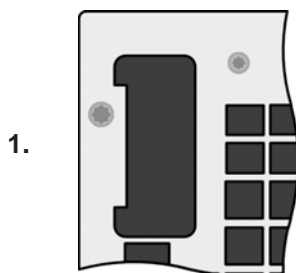

1. Remove the slot cover. If needed use a screw driver.

Check that the fixing screws of an already installed module are fully retracted. If not, unscrew them (Torx 8) and remove module.

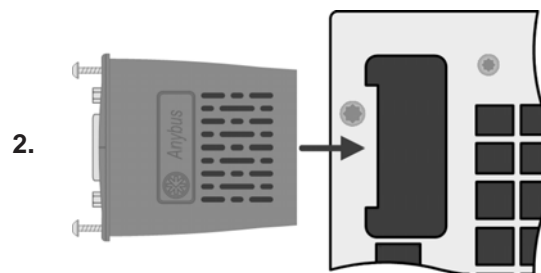

2. Insert the interface module into the slot. The shape ensures correct alignment.

When inserting take care that it's held as close as possible to a 90° angle to the rear wall of the device. Use the green PCB which you can recognize on the open slot as guide. At the end is a socket for the module.

On the bottom side of the module are two plastic nibs which must click into the green PCB so that the module is properly aligned on the rear wall of the device.

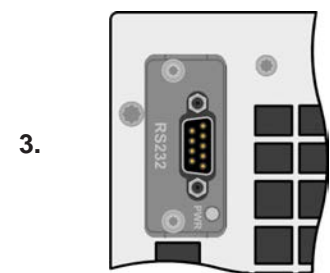

3. The screws (Torx 8) are provided for fixing the module and should be fully screwed in. After installation, the module is ready for use and can be connected.

Removal follows the reverse procedure. The screws can be used to assist in pulling out the module.

2.3.10 Connecting the “Share” bus

The “Share” bus connector on the back side is intended to balance the current of multiple units in parallel operation, especially when using the integrated function generator of the master unit. Alternatively, it can be connected to a compatible electronic load, like from series ELR 9000, in order to run a two-quadrants operation. For further information about this mode of operation can be found in section „3.11.4. Two quadrants operation (2QO)“.

For the connection of the share bus the following must be paid attention to:



- Connection is only permitted between compatible devices (see „1.9.10. “Share” connector“ for details) and between a max. of 16 units
- If a two-quadrants operation system has to be set up where multiple power supplies are connected to one electronic load unit or a group of electronic loads, all units should be connected via Share bus.
- When not using one or several units of a system configured with Share bus, because less power is required for an application, it's recommended to disconnect the unit's from the Share bus, because even when not powered they can have a negative impact on the control signal on the bus due to their impedance. Disconnection can be done by simply unplugging them from the bus or using switches.
- The Share bus is referenced to DC minus. When building a series connection (where allowed, depending on model), the DC minus will shift its potential and so will the Share bus

2.3.11 Connecting the USB port (rear side)

In order to remotely control the device via this port, connect the device with a PC using the included USB cable and switch the device on.

2.3.11.1 Driver installation (Windows)

On the initial connection with a PC the operating system will identify the device as new hardware and will try to install a driver. The required driver is for a Communications Device Class (CDC) device and is usually integrated in current operating systems such as Windows 7 or 10. But it's strongly recommended to use the included driver installer (on USB stick) to gain maximum compatibility to our softwares.

2.3.11.2 Driver installation (Linux, MacOS)

We can't provide drivers or installation instructions for these operating systems. Whether a suitable driver is available is best carried out by searching the Internet.

2.3.11.3 Alternative drivers

In case the CDC drivers described above are not available on your system, or for some reason do not function correctly, commercial suppliers can help. Search the Internet for suppliers using the keywords “cdc driver windows“ or “cdc driver linux“ or “cdc driver macos“.

2.3.12 Initial commission

For the first start-up after installation of the device, the following procedures have to be executed:

- Confirm that the connection cables to be used are of a satisfactory cross section!
- Check if the factory settings of set values, safety and monitoring functions and communication are suitable for your intended application of the device and adjust them if required, as described in the manual!
- In case of remote control via PC, read the additional documentation for interfaces and software!
- In case of remote control via the analog interface, read the section in this manual concerning analog interfaces!

2.3.13 Commission after a firmware update or a long period of non-use

In case of a firmware update, return of the equipment following repair or a location or configuration change, similar measures should be taken to those of initial start up. Refer to „2.3.12. Initial commission“.

Only after successful checking of the device as listed may it be operated as usual.

2.3.14 System extension with slave units

The 15 kW models of this series can be extended by slave units of same rating to extend power (also see „1.9.4. Accessories“) in a parallel connection system of up to 16 units in total. Other model configurations are not possible.

The slave units are without display and feature a reduced control panel, both making them cost saving options. They are configured solely using remote control, for example using our EA Power Control.

The parallel connection system uses master-slave operation (see „3.11.1. Parallel operation in master-slave (MS)“) and the Share bus. Slave units can be added step by step, just as required. Every unit comes with a master-slave cable to connect to the next unit. Cables for Share bus and DC output are to be manufactured by the user.

When using 19" cabinets, there are DC bus bars available upon request which are ready to be mounted directly to the DC output of the devices. Since the number of bus bars and required screws varies depending on the maximum current you want to achieve, it's necessary to assemble individual sets. When planning to extend the system by further units, it's advised to order and install bus bars for the final configuration even when starting with just two units.

The configuration of the master units, the standard model with display and HMI, is either done on the unit itself or via software in remote control. The slave units don't require setup, as they are preconfigured to be slaves on the master-slave bus.

3. Operation and application

3.1 Personal safety



- In order to guarantee safety when using the device, it's essential that only persons operate the device who are fully acquainted and trained in the required safety measures to be taken when working with dangerous electrical voltages
- For models which can generate a voltage which is dangerous by contact, or is connected to such, the included DC terminal cover, or an equivalent, must always be used
- Whenever the load and DC output are being re-configured, the device should be disconnected from the mains, not only the DC output switched off!

3.2 Operating modes

A power supply is internally controlled by different control circuits, which shall regulate voltage, current and power to the adjusted values and hold them constant, if possible. These circuits follow typical laws of control systems engineering, resulting in different operating modes. Each operating mode has its own characteristics which are explained below in short form.



- *Unloaded operation isn't considered as a normal operation mode and can thus lead to false measurements, for example when calibrating the device*
- *The optimal working point of the device is between 50% and 100% voltage and current*
- *It's recommended to not run the device below 10% voltage and current, in order to meet technical values like ripple or transient times*

3.2.1 Voltage regulation / Constant voltage

Voltage regulation is also called constant voltage operation (CV).

The DC output voltage of a power supply is held constant on the adjusted value, unless the output current or the output power according to $P = U_{OUT} * I_{OUT}$ reaches the adjusted current or power limit. In both cases the device will automatically change to constant current or constant power operation, whatever occurs first. Then the output voltage can't be held constant anymore and will sink to a value resulting from Ohm's law.

While the DC output is switched on and constant voltage mode is active, then the condition "CV mode active" will be indicated on the graphic display by the abbreviation CV and this message will be passed as a signal to the analog interface, as well stored as status which can also be read as a status message via digital interface.

3.2.1.1 Transient time after load step

For constant voltage mode (CV), the technical date "Transient time after load step" (see 1.8.3) defines a time that is required by the internal voltage regulator of the device to settle the output voltage after a load step. Negative load steps, i.e. high load to lower load, will cause the output voltage to overshoot for a short time until compensated by the voltage regulator. The same occurs with a positive load step, i.e. low load to high load. There the output collapses for a moment. The amplitude of the overshoot resp. collapse depends on the device model, the currently adjusted output voltage and the capacity on the DC output and can thus not be stated with a specific value.

Depictions:

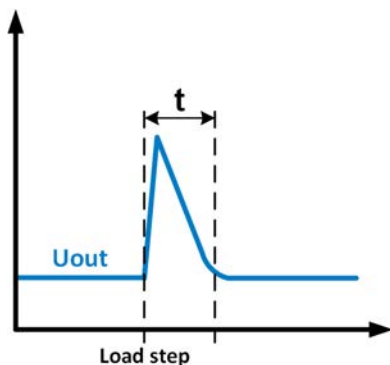

Example for neg. load step: the DC output will rise above the adjusted value for a short time. t = transient time to settle the output voltage.

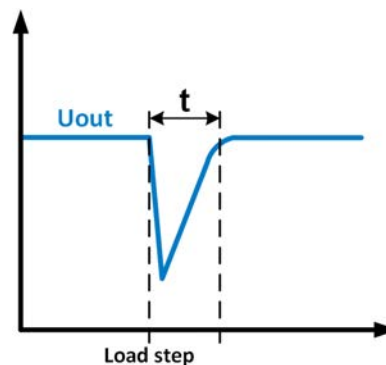

Example for pos. load step: the DC output will collapse below the adjusted value for a short time. t = transient time to settle the output voltage.

3.2.2 Current regulation / constant current / current limiting

Current regulation is also known as current limiting or constant current mode (CC).

The DC output current is held constant by the power supply, once the output current to the load reaches the adjusted limit. Then the power supply automatically switches to CC. The current flowing from the power supply is determined by the output voltage and the load's true resistance. As long as the output current is lower than the adjusted current limit, the device will be either in constant voltage or constant power mode. If, however, the power consumption reaches the adjusted power value, the device will switch automatically to power limiting and sets the output current according to $I_{MAX} = P_{SET} / U_{IN}$, even if the maximum current value is higher. The current set value, as determined by the user, is always an upper limit.

While the DC output is switched on and constant current mode is active, the condition "CC mode active" will be indicated on the graphic display with abbreviation **CC** and this message will be passed as a signal to the analog interface, as well stored as status which can also be read as a status message via digital interface.

3.2.3 Power regulation / constant power / power limiting

Power regulation, also known as power limiting or constant power (CP), keeps the DC output power of a power supply constant if the current flowing to the load in relation to the output voltage and the resistance of load reaches the adjusted value according to $P = U * I$ resp. $P = U^2 / R$. The power limiting then regulates the output current according to $I = \text{sqr}(P / R)$, where R is the load's true resistance.

Power limiting operates according to the auto-range principle such that at lower output voltages higher current flows and vice versa in order to maintain constant power within the range P_N (see diagram to the right).

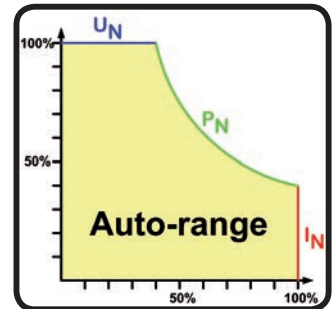

While the DC output is switched on and constant power mode is active, then the condition "CP mode active" will be shown on the graphic display by the abbreviation **CP**, as well stored as status which can also be read as a status message via digital interface.



In remote sensing operation, i. e. when the Sense input is connected to the load, the increased voltage output and thus also increased power output isn't included in the actual power value, because the device then measures and regulates the voltage on the Sense input.

3.2.4 Internal resistance regulation

Internal resistance control (short: CR) of power supplies is the simulation of a virtual internal resistor which is in series to the load. According to Ohm's law, this resistance causes a voltage drop, which will result in a difference between the adjusted output voltage and the actual output voltage. This will also work in CC or CP mode whereas the actual output voltage will differ even more from the adjusted voltage, because both modes limit the output voltage additionally. CR mode is actually running in CV, but will be indicated as CR on display once the adjusted resistance value is reached.

The adjustable resistance range of a particular model is given in the technical specifications. The voltage regulation in dependency of the resistance set value and the output current is done by calculation in a fast ARM controller, being only a little slower than other controllers inside the control circuit. Clarification:

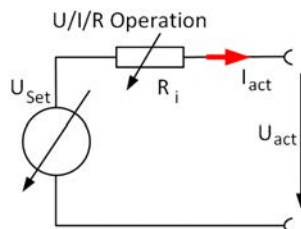
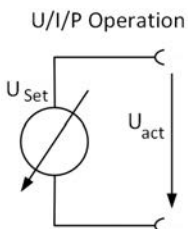

$$U_{Act} = U_{Set} - I_{Act} * R_{Set} \quad | \quad P_{Set}, I_{Set}$$

$$P_{Ri} = (U_{Set} - U_{Act}) * I_{Act}$$



With resistance mode being activated the function generator will be unavailable and the actual power value provided by the device does not include the simulated power dissipation of Ri.

3.3 Alarm conditions



This section only gives an overview about device alarms. What to do in case your device indicates an alarm condition is described in section „3.6. Alarms and monitoring“.

As a basic principle, all alarm conditions are signalled optically (text + message in the display), acoustically (if activated) and as a readable status and alarm counter via the digital interface. In addition, the alarms OT and OVP are reported as signals on the analogue interface. For later acquisition, an alarm counter can be read from the display or via digital interface.

3.3.1 Power Fail

Power Fail (PF) indicates an alarm condition which may have various causes:

- AC input voltage too low (mains undervoltage, mains failure)
- Defect in the input circuit (PFC)

As soon as a power fail occurs, the device will stop to supply power and switch off the DC output.



Switching off the device by the mains switch can't be distinguished from a mains blackout and thus the device will signalise a PF alarm every time the device is switched off. This can be ignored.



The condition of the DC output after a PF alarm during normal operation can be set up. See „3.4.3. Configuration via MENU“.

3.3.2 Overtemperature

An overtemperature alarm (OT) can occur from an excess temperature inside the device and temporarily causes it to stop supplying power. After cooling down, the device can automatically switch the power stage back on, depending on the setting of parameter “DC output after OT alarm”. See section 3.4.3.1.

3.3.3 Overvoltage protection

An overvoltage alarm (OVP) will switch off the DC output and can occur if:

- the power supply itself, as a voltage source, generates an output voltage higher than set for the overvoltage alarm threshold (OVP, 0...110% U_{Nom}) or the connected load somehow returns voltage higher than this threshold
- the OVP threshold has been adjusted too close above the output voltage. If the device is in CC mode and if it then experiences a negative load step, it will make the voltage rise quickly, resulting in a voltage overshoot for a short moment which can already trigger the OVP

This function serves to warn the user of the power supply acoustically or optically that the device probably has generated an excessive voltage which could damage the connected load application.



- The device isn't fitted with protection from external overvoltage
- The changeover from operation modes CC -> CV can generate voltage overshoots

3.3.4 Overcurrent protection

An overcurrent alarm (OCP) will switch off the DC output and can occur if:

- the output current in the DC output reaches the adjusted OCP limit.

This function serves to protect the connected load application so that this isn't overloaded and possibly damaged due to an excessive current.

3.3.5 Overpower protection

An overpower alarm (OPP) will switch off the DC output and can occur if:

- the product of the output voltage and output current in the DC output reaches the adjusted OPP limit.

This function serves to protect the connected load application so that this isn't overloaded and possibly damaged due to an excessive power consumption.

3.4 Manual operation

3.4.1 Switching on the device

The device should, as far as possible, always be switched on using the rotary switch on the front of the device. Alternatively this can take place using an external cutout (contactor, circuit breaker) of suitable current capacity.

After switching on, the display will first show some device related information (model, firmware versions etc.) and then a language selection screen for 3 seconds. A few seconds later it will show the main screen.

In setup (see section „3.4.3. Configuration via MENU“ in the second level menu “**General settings**” is an option “**Output after power ON**” in which the user can determine the condition of the DC output after power-up. Factory setting here is “**OFF**”, meaning that the DC output on power-up is always switched off. “**Restore**” means that the last condition of the DC output will be restored, either on or off. All set values are always saved and restored.



For the time of the start phase the analog interface can signal undefined statuses on the output pins such as ALARMS 1. Those signal must be ignored until the device has finished booting and is ready to work.

3.4.2 Switching off the device

On switch-off the last output condition and the most recent set values are saved. Furthermore, a PF alarm (power failure) will be reported, but can be ignored.

The DC output is immediately switched off and after a short while fans will shut down and after another few seconds the device will be completely powered off.

3.4.3 Configuration via MENU

The MENU serves to configure all operating parameters which are not constantly required. These can be set by finger touch on the MENU touch area, but only if the DC output is switched OFF. See figure to the right.

If the DC output is switched on the settings menu will not be shown, only status information.

Menu navigation is by finger touch. Values are set using the rotary knobs. The assignment of the knobs to the adjustable values isn't indicated in menu pages, but there is an assignment rule: upper value -> lefthand knob, lower values -> righthand knob.

Some setting parameters are self-explanatory, others are not. The latter will be explained on the pages following.

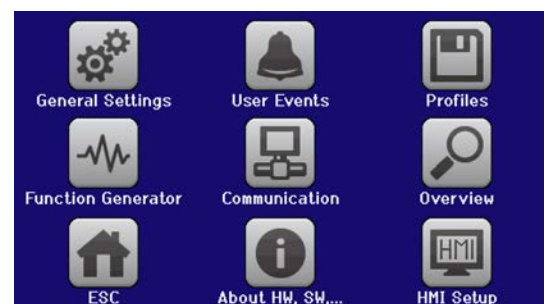
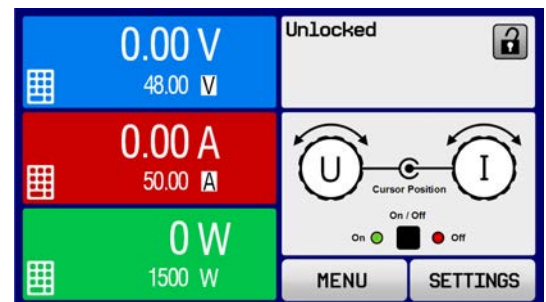

3.4.3.1 Menu “General Settings”

Setting	Description
Allow remote control	Selection “ NO ” means that the device can’t be remotely controlled over either the digital or analog interfaces. If remote control isn’t allowed, the status will be shown as “ local ” in the status area on the main display. See also section 1.9.6.1
Analog interface range	Selects the voltage range for the analog set inputs, actual value outputs and reference voltage output. <ul style="list-style-type: none"> • 0...5 V = Range is 0...100% set /actual values, reference voltage 5 V • 0...10 V = Range is 0...100% set /actual values, reference voltage 10 V Also see „3.5.4. Remote control via the analog interface (AI)“
Analog interface Rem-SB	Selects how the input pin REM-SB of the analog interface shall be working regarding levels (see „3.5.4.4. Analog interface specification“) and logic: <ul style="list-style-type: none"> • Normal = Levels and function as described in the table in 3.5.4.4 • Inverted = Levels and function will be inverted Also see „3.5.4.7. Application examples“
Analog Rem-SB action	Selects the action on the DC output that is initiated when changing the level of analog input REM-SB: <ul style="list-style-type: none"> • DC OFF = the pin can only be used to switch the DC output off • DC AUTO = the pin can be used to switch the DC output off and on again, if it has been switched on before at least from a different control location
Analog interface pin 6	Pin 6 of the analog interface (see section 3.5.4.4) is by default assigned to only signal the device alarms OT and PF. This parameter allows to also enable signaling only one of both (3 possible combinations): <p>Alarm OT = Enable/disable alarm OT on pin 6</p> <p>Alarm PF = Enable/disable alarm PF on pin 6</p>
Analog interface pin 14	Pin 14 of the analog interface (see section 3.5.4.4) is by default assigned to only signal the device alarm OVP. This parameter allows to also enable signaling further device alarms (7 possible combinations): <p>Alarm OVP = Enable/disable alarm OVP on pin 14</p> <p>Alarm OCP = Enable/disable alarm OCP on pin 14</p> <p>Alarm OPP = Enable/disable alarm OPP on pin 14</p>
Analog interface pin 15	Pin 15 of the analog interface (see section 3.5.4.4) is by default assigned to only signal the regulation mode CV. This parameter allows to enable signaling a different device status (2 options): <p>Regulation mode = Enable/disable signaling of CV reg mode on pin 15</p> <p>DC status = Enable/disable signaling of DC output status on pin 15</p>
DC output after OT alarm	Determines how the DC power stages shall react after an overtemperature (OT) alarm has occurred and the power stages have cooled down again: <ul style="list-style-type: none"> • OFF = DC power stage(s) will be off • AUTO = The device will automatically restore the situation before the OT alarm, which usually means the DC power stage(s) to be on
DC output after power ON	Determines the condition of the DC output after power-up. <ul style="list-style-type: none"> • OFF = DC output is always off after switching on the device. • Restore = DC output condition will be restored to the condition prior to switch off.
DC output after PF alarm	Determines how the DC output shall react after a power fail (PF) alarm has occurred: <ul style="list-style-type: none"> • OFF = DC output will be switched off and remain until user action • AUTO = DC output will switch on again after the PF alarm cause is gone and if it was switched on before the alarm occurred
DC output after remote	Determines the condition of the DC output after leaving remote control either manually or by command. <ul style="list-style-type: none"> • OFF = DC output will be always off when switching from remote to manual • AUTO = DC output will keep the last condition

Setting	Description
Enable R mode	Activates (“ Yes ”) or deactivates (“ No ”) the internal resistance control. If activated, the resistance set value can be adjusted on the main screen as additional value. For details refer to „3.2.4. <i>Internal resistance regulation</i> “
USB decimal point format	Switches the decimal point format of values and also the CSV file separator for USB logging and for other features where CSV file can be loaded US = Comma separator (US standard for CSV files) Default = Semicolon separator (german/european standard for CSV files)
USB logging with units (V,A,W)	CSV files generated from USB logging by default add physical units to values. This can be deactivated by setting this option to “ No ”
Calibrate device	Touch area “ Start ” starts a calibration routine (see „4.3. <i>Calibration</i> “), but only if the device is in U/I or U/P mode.
Reset device to defaults	Touch area “ Start ” will initiate a reset of all settings (HMI, profile etc.) to factory default, as shown in the menu structure diagrams on the previous pages
Restart device	Will initiate a warm start of the device
Master-slave mode	Selecting “ MASTER ” or “ SLAVE ” enables the master-slave mode (MS) and set the selected position for the unit in the MS system. Default setting: OFF . This applies to the digital MS bus, the analog Share bus and two-quadrants operation. For details see sections „3.11.1. <i>Parallel operation in master-slave (MS)</i> “ and „3.11.4. <i>Two quadrants operation (2QO)</i> “.
Repeat master init.	Touch area “ Initialize ” will repeat the initialization of the master-slave system in case the automatic enumeration of the slave units by the master is once unsuccessful so the system would have less total power than expected or has to be repeated manually in case the master unit couldn’t detect a missing slave

3.4.3.2 Menu “User Events”

See „3.6.2.1 *User defined events*“ on page 62.

3.4.3.3 Menu “Profiles”

See „3.9 *Loading and saving a user profile*“ on page 64.

3.4.3.4 Menu “Overview”

This menu page displays an overview of the set values (U, I, P or U, I, P, R) and alarm settings as well as settings limits. These can only be displayed, not changed.

3.4.3.5 Menu “About HW, SW...”

This menu page displays an overview of device relevant data such as serial number, article number etc., as well as an alarm history which lists the number of device alarms that probably occurred since the device has been powered.

3.4.3.6 Menu “Function Generator”

See „3.10 *The function generator*“ on page 65.

3.4.3.7 Menu “Communication”

This sub menu offers settings for digital communication via the optional or built-in interface. The button for the installed interface module or the optional GPIB port opens one or more settings pages, depending on the interface in use. There is furthermore an adjustable communication timeout, to make it possible to successfully transfer fragmented messages (data packets) using higher values. In the screen for “Com Protocols” you can enable both or disable one of the two supported communication protocols, ModBus and SCPI. This can help to avoid mixing both protocols and to receive unreadable messages, for example when expecting a SCPI response and getting a ModBus response instead.



For all Ethernet interfaces with two ports: „P1“ is related to port 1 and „P2“ to port 2, like printed on the module face. Two-port interfaces will use one IP only.

IF	Level 1	Level 2	Level 3	Description
Ethernet / ModBus-TCP, 1 & 2 Port	IP Settings 1	DHCP		The IF allows a DHCP server to allocate an IP address, a subnet mask and a gateway. If no DHCP server is in the network then network parameters will be set as defined in item "Manual"
		Manual	IP address	This option is activated by default. An IP address can be manually allocated.
			Gateway	Here a gateway address can be allocated if required..
			Subnet mask	Here a subnet mask can be defined if the default subnet mask isn't suitable.
		DNS address 1 DNS address 2	Here the addresses of the first and second Domain Name Servers (DNS) can be defined, if needed.	
		Port	Range: 0...65535. Default ports: 5025 = Modbus RTU (all Ethernet interfaces) Reserved ports which must not be set with this parameter: 502 = Modbus TCP (Modbus-TCP interface only) other typical reserved ports	
	IP Settings 2-P1 IP Settings 2-P2	AUTO		Settings for the Ethernet port such as transmission speed are set automatically.
	Manual	Half duplex	Manual selection for transmission speed (10MBit/100MBit) and duplex mode (full/half). It's recommended to use the "AUTO" option and only revert to "Manual" if these parameters fail. Different Ethernet port settings for 2-port modules are possible, as these include an Ethernet switch	
		Full duplex		
		10MBit		
100MBit				
Host name			Free choice of host name (default: Client)	
Domain name			Free choice of Domain (default: Workgroup)	
TCP Keep-Alive	Enable TCP keep-alive			

IF	Level 1	Description
Profinet/IO, 1 & 2 Port	Function Tag	String input box for a user-definable text which describes the Profinet slave function tag. Max. length: 32 characters
	Location Tag	String input box for a user-definable text which describes the Profinet slave location tag. Max. length: 22 characters
	Station Name	String input box for a user-definable text which describes the Profinet station name. Max. length: 200 characters
	Description	String input box for a user-definable text which describes the Profibus slave. Max. length: 54 characters
	Installation Date	String input box for a user-definable text which describes the Profibus slave installation date tag. Max. length: 40 characters

IF	Level 1	Description
Profibus DP	Node Address	Selection of the Profibus or node address of the device within range 1...125 via direct input
	Function Tag	String input box for a user-definable text which describes the Profibus slave function tag. Max. length: 32 characters
	Location Tag	String input box for a user-definable text which describes the Profibus slave location tag. Max. length: 22 characters
	Installation Date	String input box for a user-definable text which describes the Profibus slave installation date tag. Max. length: 40 characters
	Description	String input box for a user-definable text which describes the Profibus slave. Max. length: 54 characters

IF	Ebene 1	Level 2	Level 3	Description		
CAN	Base ID			Setup of the CAN base ID (11 Bit or 29 Bit, hex format). Default: 0h		
	Baud Rate			Setup of the CAN bus speed or baud rate in typical value between 10 kbps and 1Mbps. Default: 500 kbps		
	Termination			Activates or deactivates CAN bus termination with a built-in resistor. Default: OFF		
	Broadcast ID			Setup of the CAN broadcast ID (11 Bit or 29 Bit, hex format). Default: 7ffh		
	ID Format			Selection of the CAN ID format between Base (11 Bit ID, 0h...7ffh) and Extended (29 Bit, 0h...1ffffffh)		
	Cyclic Communication	Base ID Cyclic Read			Setup of the CAN base ID (11 Bit or 29 Bit, hex format) for cyclic read of up to 5 object groups (see " Cyclic Read Timing "). The device will automatically send specific object data to the IDs defined with this setting. For more information refer to the programming guide. Default: 100h	
			Base ID Cyclic Send		Setup of the CAN base ID (11 Bit or 29 Bit, hex format) for cyclic send of the three set values for U, I and P along with status in one single message. For more information refer to the programming guide. Default: 200h	
			Cyclic Read Timing	Status		Activation/deactivation and time setting for the cyclic read of status to the adjusted „ Base ID Cyclic Read + 1 “ Range: 20...5000 ms. Default: 0 (deactivated)
				Actual val.		Activation/deactivation and time setting for the cyclic read of actual values to the adjusted „ Base ID Cyclic Read + 2 “ Range: 20...5000 ms. Default: 0 (deactivated)
				Set val.		Activation/deactivation and time setting for the cyclic read of set values of U & I to the adjusted „ Base ID Cyclic Read + 3 “ Range: 20...5000 ms. Default: 0 (deactivated)
Limits 1					Activation/deactivation and time setting for the cyclic read of adjustment limits of P & R to the adjusted „ Base ID Cyclic Read + 4 “ Range: 20...5000 ms. Default: 0 (deactivated)	
Limits 2		Activation/deactivation and time setting for the cyclic read of adjustment limits of P & R to the adjusted „ Base ID Cyclic Read + 4 “				
Data Length			Determines the DLC (data length) of all messages sent from the device. AUTO = length varies between 3 and 8 bytes, depending on object Always 8 Bytes = length is always 8, filled up with zeros			

IF	Level 1	Level 2	Description
CANopen	Node Address		Selection of the CANopen node address in the range 1...127
	Baud Rate	AUTO	Automatic detection of the bus baud rate.(speed)
		LSS	Automatically sets baud rate and node address
	Manual	Manual selection of the baud rate that is used by the CANopen interface. Possible selections: 10 kbps, 20 kbps, 50 kbps, 100 kbps, 125 kbps, 250 kbps, 500 kbps, 800 kbps, 1Mbps (1Mbps = 1 Mbit/s, 10 kbps = 10 kbit/s)	

IF	Level 1	Description
RS232	-	The baud rate is selectable, other serial settings can't be changed and are defined like this: 8 data bits, 1 stop bit, parity = none Baud rates: 2400, 4800, 9600, 19200, 38400, 57600, 115200

IF	Level 1	Description
GPIB	Node Address	Adjustment of the GPIB node address (only with option 3W installed) in the range 1...30

Element	Description
Com Timeout	<p>Timeout USB/RS232 (in milliseconds) Default value: 5, Range: 5...65535 Defines the max. time between two subsequent bytes or blocks of a transferred message. For more information about the timeout refer to the external programming documentation "Programming ModBus & SCPI".</p> <p>Timeout ETH (in seconds) Default value: 5, Range: 0 or 5...65535 If there was no communication between the controlling unit (PC, PLC etc.) and the device for the adjusted time, it will close the socket connection. This timeout will be ineffective as long as the option "TCP keep-alive" (see above, table for Ethernet module) is activated and "keep-alive" is working as expected within the network. Setting "0" deactivates the timeout permanently.</p>
Com Protocols	<p>Default: both enables</p> <p>Enables/disables SCPI or ModBus communication protocols for the device. The change is immediately effective after submitting it with ENTER button. Only one of both can be disabled.</p>
Logging	<p>Default setting: disabled</p> <p>Enables/disables the "log to USB stick" feature. Once enabled, you can define the log interval (multiple steps, 500 ms ... 5 s) and the control method. For more information refer to „3.4.10. Recording to USB stick (logging)“.</p>

3.4.3.8 Menu "HMI Setup"

These settings refer exclusively to the control panel (HMI).

Element	Description
Language	Selection of the display language between German, English (default), Russian or Chinese
Key Sound	Activates or deactivates sounds when touching a touch area in the display. It can usefully signal that the action has been accepted.
Alarm Sound	Activates or deactivates the additional acoustic signal of an alarm or user defined event which has been set to "Action = ALARM". See also „3.6 Alarms and monitoring“ on page 61.
HMI Lock	See „3.7 Control panel (HMI) lock“ on page 63.
Backlight	The choice here is whether the backlight remains permanently on or if it should be switched off when no input via screen or rotary knob is made for 60 s. As soon as input is made, the backlight returns automatically. Furthermore, the backlight intensity can be adjusted here.
Status page	<p>Enables/disables two display related options for the main screen with actual and set values:</p> <p>Show meter bar: in U/I/P mode, i. e. resistance mode not activated, a meter bar for 0-100% actual values of voltage, current and power is shown. See „3.4.8. The meter bars“.</p> <p>Alternative status page: switches the main screen of the device with its actual and set values of voltage, current, power and - if activated - resistance to a simpler display with only voltage and current, plus status. See „3.4.7. Switching the main screen view“.</p> <p>Default setting: both disabled</p>
Limits Lock	See „3.8 Limits lock“ on page 63

3.4.4 Adjustment limits



Adjustment limits are only effective on the related set values, no matter if using manual adjustment or remote control setting!



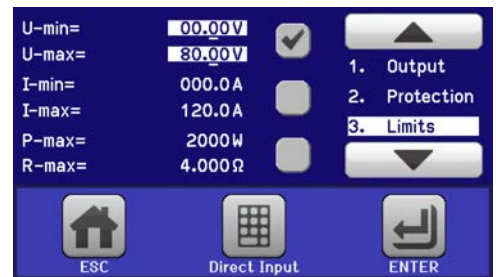

Defaults are that all set values (U, I, P, R) are adjustable from 0 to 102%.

The full range may be obstructive in some cases, especially for protection of applications against overvoltage. Therefore upper and lower limits for current (I) and voltage (U) can be set separately, which then limit the range of the adjustable set values.

For power (P) and resistance (R) only upper value limits can be set.



► How to configure the adjustment limits

1. On the main screen, tap **SETTINGS** to access the SETTINGS menu.
2. Tap the arrows   to select "3. Limits".
3. In each case a pair of upper and lower limits for U/I or the upper limit for P/R are assigned to the rotary knobs and can be adjusted. Tap the selection area for another choice .
4. Accept the settings with .



The set values can be entered directly using the ten-key pad. This appears when the touch area "Direct Input" is tapped (bottom centre)



The adjustment limits are coupled to the set values. It means, that the upper limit may not be set lower than the corresponding set value. Example: If you wish to set the limit for the power set value (P-max) to 6000 W while the currently adjusted power set value is 8000 W, then the set value first would have to be reduced to 6000 W or less, in order to set P-max down to 6000 W.

3.4.5 Changing the operating mode

In general, the manual operation of a PSI 9000 3U distinguishes between two resp. three operating modes, U/I and U/P and U/R, which are tied to set value input using the rotary knobs or ten-key pad. This assignment must be changed if one of the three resp. four set values is to be adjusted which is currently not accessible.

► How to change the operating mode (two options)

1. Unless the device is in remote control or the panel is locked, you can switch the operation anytime. Tap on the depiction of the right-hand knob (see figure to the right) to change its assignment between I, P and R (if resistance mode had been enabled), which is then displayed accordingly.
2. Directly tap on the coloured areas with the set values, like shown in the figure to the right. The physical unit next to the set value, when inverted, indicates the assignment to the knob. In the example in the figure it has U and P assigned, which means U/P mode.

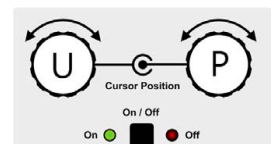

Depending on the selection the right rotary knob will be assigned different setting values, the left knob is always assigned to the voltage.



In order to change the other values, like P or R while U/I is active, and without switching the assignment all the time, direct input can be used. See section 3.4.6. for details.

The actual operating mode, which is only indicated while the DC output is switched on, solely depends on the set values. For more information see section „3.2. Operating modes“.

3.4.6 Manual adjustment of set values

The set values for voltage, current and power are the fundamental operating possibilities of a power supply and hence the two rotary knobs on the front of the device are always assigned to two of the values in manual operation.

As a fourth value there is the internal resistance, for which the resistance mode (R mode) has to be activated in the MENU first. Refer to „3.4.3. Configuration via MENU“ and „3.2.4. Internal resistance regulation“ for details.

Set values can be entered manually in two ways: via **rotary knob** or **direct input**. While the rotary knobs adjust values continuously, entering them via numeric pad can be used to change values in bigger steps.



Entering a value changes it immediately and no matter if the DC output is switched on or off.



When adjusting set values, upper or lower limits may come into effect. See section „3.4.4. Adjustment limits“. Once a limit is reached, the display will show a note like “Limit: U-max” etc. for 1.5 seconds next to the adjusted value.

► How to adjust set values U, I, P or R with the rotary knobs

1. First check if the value you want to change is already assigned to one of the rotary knobs. The main screen displays the assignment as depicted in the figure to the right.
2. If, as shown in the example, the assignment is voltage (U, left) and power (P, right), and it's required to set the current, then the assignments can be changed by tapping this touch area. A set of selection fields then appears.
3. After successful selection, the desired value can be set within the defined limits. Selecting a digit is done by pushing the rotary knob which shifts the cursor from right to left (selected digit will be underlined):

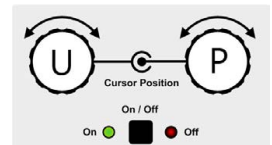

► How to adjust values via direct input:

1. In the main screen, depending on the rotary knob assignment, values can be set for voltage (U), current (I), power (P) or resistance (R) via direct input by tapping on the set/actual value display areas, e.g. in the uppermost area of voltage.
2. Enter the required value using the ten-key pad. Similar to a pocket calculator the key **c** clears the input.

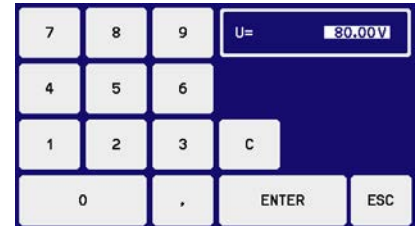

Decimal values are set by tapping the point key. For example, 54.3 V

is set with **5** **4** **.** **3** and **ENTER**.

3. The display then switches back to the main page and the set values take effect.

3.4.7 Switching the main screen view

The main screen, also called status page, with its set values, actual values and device status can be switched from the standard view mode with three or four values to a simpler mode with only voltage and current display. The advantage of the alternative view mode is that actual values are displayed with **bigger characters**, so they read be read from a larger distance. Refer to „3.4.3.8. Menu “HMI Setup”“ to see where to switch the view mode in the MENU. Comparison:

Standard status page

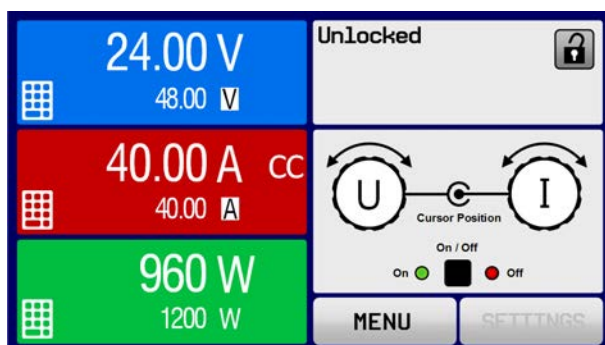

Alternative status page

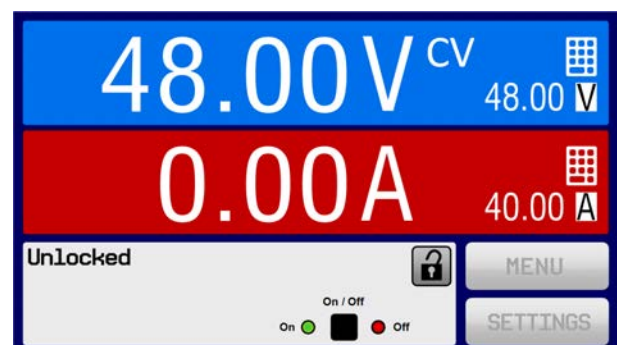

Limitations of the alternative status page:

- Set and actual values of power are not displayed and the set value of power is only indirectly accessible
- The set value of resistance isn't displayed and only indirectly accessible
- No access to the settings overview (MENU button) while the DC output is on



In alternative status page mode, the set values of power and resistance are not adjustable while the DC output is switched on. They can only be accessed and adjusted in SETTINGS while the DC output is off.

Rules for manual handling of the HMI in alternative status page mode:

- The two rotary knobs are assigned to voltage (left knob) and current (right knob) all the time, except for menus
- Set values input is the same as in standard status page mode, with knobs or by direct input
- Regulation modes CP and CR are displayed alternatively to CC at the same position

3.4.8 The meter bars

Additionally to the actual values being displayed as numbers, a meter bar for U, I and P can be enabled in the MENU. The meter bars remain hidden as long as resistance mode, i. e. U/I/R is activated. Refer to „3.4.3.8. Menu “HMI Setup”“ to see where to enable the meter bars in the MENU. Depiction:

Standard status page with meter bar

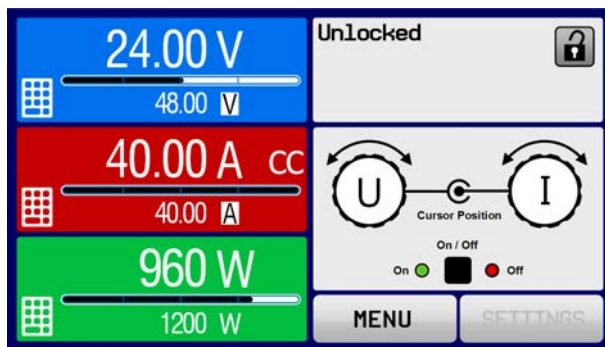

Alternative status page with meter bar

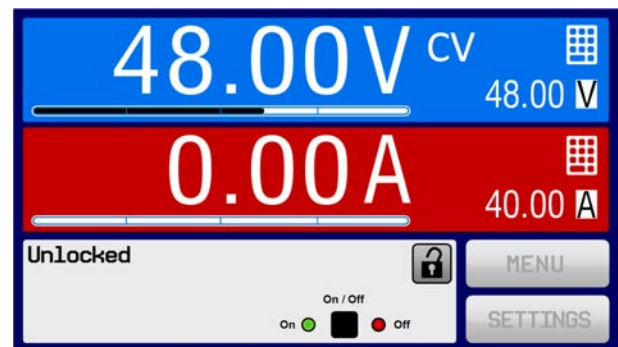

3.4.9 Switching the DC output on or off

The DC output of the device can be manually or remotely switched on and off. This can be restricted in manual operation by the control panel being locked.



Switching the DC output on during manual operation or digital remote control can be disabled by pin REM-SB of the built-in analog interface. For more information refer to 3.4.3.1 and example a) in 3.5.4.7.

► How to manually switch the DC output on or off

1. As long as the control panel isn't fully locked press the button ON/OFF. Otherwise you are asked to disable the HMI lock first.
2. This button toggles between on and off, so long as a change isn't restricted by an alarm or the device is locked in "remote". The current condition is indicated by the LEDs next to button "On/Off".

► How to remotely switch the DC output on or off via the analog interface

1. See section „3.5.4 Remote control via the analog interface (AI)“ on page 57.

► How to remotely switch the DC output on or off via the digital interface

1. See the external documentation "Programming Guide ModBus & SCPI" if you are using custom software, or refer to the external documentation from LabView VIs or other software provided by the manufacturer.

3.4.10 Recording to USB stick (logging)

Device data can be recorded to USB stick (2.0 / 3.0 may work, but not all vendors are supported) anytime. For specifications of the USB stick and the generated log files refer to section „1.9.6.5. USB port (front side)“.

The logging stores files of CSV format on the stick. The layout of the log data is the same as when logging via PC with software EA Power Control. The advantage of USB logging over PC logging is the mobility and that no PC is required. The logging feature just has to be activated and configured in the MENU.

3.4.10.1 Configuration 1



Also see section 3.4.3.7. After USB logging has been enabled and the parameters “Logging interval” and “Start/Stop” have been set, logging can be started anytime from within the MENU or after leaving it, depends on the selected start/stop mode.

3.4.10.2 Configuration 2

Also see section 3.4.3.1. There are additional settings for the CSV file itself as generated by the USB logging features. You can switch the column separator format between german/european standard (“Default”) or US american standard (“US”). The other option is used to deactivate the physical unit that is added by default to every values in the log file. Deactivating this option simplifies the CSV file processing in MS Excel.

3.4.10.3 Handling (start/stop)

With setting “**Start/stop with DC output ON/OFF**” logging will start each time the DC output of the device is switched on, no matter if manually with the front button “On/Off” or remotely via analog or digital interface. With setting “**Manual start/stop**” it’s different. Logging is then started and stopped only in the MENU, in the logging configuration page.

Soon after logging has been started, the symbol  indicates the ongoing logging action. In case there is an error while logging, such as USB stick full or removed, it will be indicated by another symbol (). After every manual stop or switching the DC output off the logging is stopped and the log file closed.

3.4.10.4 Log file format

Type: text file in german/european or US american CSV format (depending on the selected setting)

Layout (default german format shown):

	A	B	C	D	E	F	G	H	I	J	K	L	M
1	U set	U actual	I set	I actual	P set	P actual	R set	R actual	R mode	Output/Input	Device mode	Error	Time
2	2,00V	11,92V	1,20A	1,20A	7344W	15W	N/A	N/A	OFF	ON	CC	NONE	00:00:00,942
3	2,00V	11,90V	1,20A	1,20A	7344W	15W	N/A	N/A	OFF	ON	CC	NONE	00:00:01,942
4	2,00V	11,89V	1,20A	1,20A	7344W	15W	N/A	N/A	OFF	ON	CC	NONE	00:00:02,942
5	2,00V	11,87V	1,20A	1,20A	7344W	15W	N/A	N/A	OFF	ON	CC	NONE	00:00:03,942

Legend:

U set / I set / P set / R set: Set values

U actual / I actual / P actual / R actual: Actual values

Error: device alarms

Time: elapsed time since logging start

Device mode: actual regulation mode (also see „3.2. Operating modes“)

Important to know:

- R set and R actual are only recorded if UIR mode is active (refer to section 3.4.5)
- Unlike the logging on PC, every log start here creates a new log file with a counter in the file name, starting generally with 1, but minding existing files

3.4.10.5 Special notes and limitations

- Max. log file size (due to FAT32 formatting): 4 GB
- Max. number of log files in folder HMI_FILES: 1024
- With setting “**Start/stop with DC output ON/OFF**”, the logging will also stop on alarms or events with action “Alarm”, because they switch off the DC output
- With setting “**Manual start/stop**” the device will continue to log even on occurring alarms, so this mode can be used to determine the period of temporary alarms like OT or PF

3.5 Remote control

3.5.1 General

Remote control is possible via the built-in analog or USB port or via one of the optional interface modules (only with standard models of PSI 9000 3U series) or via the GPIB port (only with option 3W installed). Important here is that only the analog or one digital interface can be in control. One of the digital ones is the master-slave bus.

It means that if, for example, an attempt were to be made to switch to remote control via the digital interface whilst analog remote control is active (pin Remote = LOW) the device would report an error via the digital interface. In the opposite direction, a switch-over via pin Remote would be ignored. In both cases, however, status monitoring and reading of values are always possible.

3.5.2 Control locations

Control locations are those locations from where the device can be controlled. Essentially there are two: at the device (manual operation) and external (remote control). The following locations are defined:

Displayed location	Description
-	If neither of the other locations is displayed then manual control is active and access from the analog and digital interfaces is allowed. This location isn't explicitly displayed
Remote	Remote control via any interface is active
Local	Remote control is locked, only manual operation is allowed.

Remote control may be allowed or inhibited using the setting “**Allow remote control**” (see „3.4.3.1. Menu “General Settings”). In *inhibited* condition the status “**Local**” will be displayed top right. Activating the inhibit can be useful if the device is remotely controlled by software or some electronic device, but it's required to make adjustments at the device or deal with emergency, which would not be possible remotely.

Activating condition “**Local**” causes the following:

- If remote control via the digital interface is active (“**Remote**”), then it's immediately terminated and in order to continue remote control once “**Local**” is no longer active, it has to be reactivated at the PC
- If remote control via the analog interface is active (“**Remote**”), then it's temporarily interrupted until remote control is allowed again by deactivating “**Local**”, because pin REMOTE continues to signal “remote control = on”, unless this has been changed during the “**Local**” period.

3.5.3 Remote control via a digital interface

3.5.3.1 Selecting an interface

The standard models of series PSI 9000 3U support, in addition to the built-in USB port, the following optionally available interface modules:

Short ID	Type	Ports	Description*
IF-AB-CANO	CANopen	1	CANopen slave with generic EDS
IF-AB-RS232	RS232	1	Standard RS232, serial
IF-AB-PBUS	Profibus	1	Profibus DP-V1 slave
IF-AB-ETH1P	Ethernet	1	Ethernet TCP
IF-AB-PNET1P	ProfiNet	1	Profinet DP-V1 slave
IF-AB-MBUS	ModBus TCP	1	ModBus TCP via Ethernet
IF-AB-ETH2P	Ethernet	2	Ethernet TCP, with switch
IF-AB-MBUS2P	ModBus TCP	2	ModBus TCP via Ethernet
IF-AB-PNET2P	ProfiNet	2	Profinet DP-V1 slave, with switch
IF-AB-CAN	CAN	1	CAN 2.0 A / 2.0 B
IF-AB-ECT	EtherCAT	2	Basic EtherCAT slave with CANopen over Ethernet (CoE)

* For technical details of the various modules see the extra documentation “Programming Guide Modbus & SCPI”

Models with option 3W installed offer an additional pre-installed GPIB port next to the default USB port.

3.5.3.2 General information about the interface modules

With the standard models of series PSI 9000 3U, one of the plug-in and retrofittable modules listed in 3.5.3.1 can be installed. It can take over remote control of the device alternatively to the built-in USB type B on the back side or analog interface. For installation see section „2.3.9. Installation of an interface module“ and separate documentation.

The modules require little or no settings for operation and can be directly used with their default configuration. All specific settings will be permanently stored such that, after changeover between the various models, no reconfiguration will be necessary.

3.5.3.3 Programming

Programming details for the interfaces, the communication protocols etc. are to be found in the documentation “Programming Guide ModBus & SCPI“ which is supplied on the included USB stick or which is available as download from the manufacturer’s website.

3.5.4 Remote control via the analog interface (AI)

3.5.4.1 General

The built-in, galvanically isolated, 15-pole analog interface (short: AI) is on the back side of the device offers the following possibilities:

- Remote control of current, voltage, power and internal resistance
- Remote status monitoring (CC/CP, CV, DC output)
- Remote alarm monitoring (OT, OVP, OCP, OPP, PF)
- Remote monitoring of actual values
- Remote on/off switching of the DC output

Setting the set values of voltage, current and power via the analog interface must always be done concurrently. It means, that for example the voltage can’t be given via the AI and current and power set by the rotary knobs, or vice versa. The internal resistance set value can additionally be adjusted.

The OVP set value and other supervision (events) and alarm thresholds can’t be set via the AI and therefore must be adapted to the given situation before the AI will be in control. Analog set values can be supplied by an external voltage or generated from the reference voltage on pin 3. As soon as remote control via the analog interface is activated, the displayed set values will be those provided by the interface.

The AI can be operated in the common voltage ranges 0...5 V and 0...10 V, both representing 0...100% of the nominal value. The selection of the voltage range can be done in the device setup. See section „3.4.3. Configuration via MENU“ for details. The reference voltage sent out from pin 3 (VREF) will be adapted accordingly:

0-5 V: Reference voltage = 5 V, 0...5 V set value signal for VSEL, CSEL, PSEL and RSEL correspond to 0...100% nominal value, 0...100% actual values correspond to 0...5 V at the actual value outputs CMON and VMON.

0-10 V: Reference voltage = 10 V, 0...10 V set value signal for VSEL, CSEL, PSEL and RSEL correspond to 0...100% nominal values, 0...100% actual values correspond to 0...10 V at the actual value outputs CMON and VMON.

Input of excess signals (e.g. >5 V in selected 5 V range or >10 V in the 10 V range) are clipped by the device by setting the corresponding set value to 100%.

Before you begin, please read these important notes about the use of the interface:



After powering the device and during the start phase the AI signals undefined statuses on the output pins. Those must be ignored until is ready to work.

- Analog remote control of the device must be activated by switching pin REMOTE (5) first. Only exception is pin REM-SB, which can be used independently since KE firmware version 2.07
- Before the hardware is connected that will control the analog interface, it shall be checked that it can’t provide voltage to the pins higher than specified
- Set value inputs, such as VSEL, CSEL, PSEL and RSEL (if R mode is activated), must not be left unconnected (i.e. floating) during analog remote control. In case any of the set values isn’t used for adjustment, it can be tied to a defined level or connected to pin VREF (solder bridge or different), so it gives 100%

3.5.4.2 Resolution and sample rate

The analog interface is internally sampled and processed by a digital microcontroller. This causes a limited resolution of analog steps. The resolution is the same for set values (VSEL etc.) and actual values (VMON/CMON) and is 26214 when working with the 10 V range. In the 5 V range this resolution halves. Due to tolerances, the truly achievable resolution can be slightly lower.

There is furthermore a max. sample rate of 500 Hz. It means, the device can acquire analog set values and states on digital pins 500 times per second.

3.5.4.3 Acknowledging device alarms

In case of a device alarm occurring during remote control via analog interface, the DC input will be switched off the same way as in manual control. Alarms are signalled either on pin ALARMS 1 or ALARMS 2, as configured in the MENU (see section „3.4.3. Configuration via MENU“). In case several alarms occur at once, the particulars ones can only read from the unit in the display (alarm counter in MENU) or via digital interface.

Device alarms have to be acknowledged, i. e. deleted, also in analog remote control. Also see „3.6.2. Device alarm and event handling“. Acknowledgement is done with pin REM-SB switching the DC output off and on again, specifically with a HIGH-LOW-HIGH edge (min. 50ms for LOW), when using the default level setting for this pin, else it would be LOW-HIGH-LOW.

3.5.4.4 Analog interface specification

Pin	Name	Type*	Description	Default levels	Electrical specifications
1	VSEL	AI	Set voltage value	0...10 V or. 0...5 V correspond to 0..100% of U_{Nom}	Accuracy 0-5 V range: < 0.4% ***** Accuracy 0-10 V range: < 0.2% ***** Input impedance R_i >40 k... 100 k
2	CSEL	AI	Set current value	0...10 V or. 0...5 V correspond to 0..100% of I_{Nom}	
3	VREF	AO	Reference voltage	10 V or 5 V	Tolerance < 0.2% at $I_{max} = +5$ mA Short-circuit-proof against AGND
4	DGND	POT	Digital ground		For control and status signals
5	REMOTE	DI	Switching internal / remote control	Remote = LOW, $U_{Low} < 1$ V Internal = HIGH, $U_{High} > 4$ V Internal = Open	Voltage range = 0...30 V $I_{Max} = -1$ mA at 5 V U_{LOW} to HIGH typ. = 3 V Rec'd sender: Open collector against DGND
6	ALARMS 1	DO	Overheating or power fail alarm	Alarm = HIGH, $U_{High} > 4$ V No alarm = LOW, $U_{Low} < 1$ V	Quasi open collector with pull-up against V_{cc} ** With 5 V on the pin max. flow +1 mA $I_{Max} = -10$ mA at $U_{CE} = 0,3$ V $U_{Max} = 30$ V Short-circuit-proof against DGND
7	RSEL	AI	Set internal resistance value	0...10 V or. 0...5 V correspond to 0..100% of R_{Max}	Accuracy 0-5 V range: < 0.4% ***** Accuracy 0-10 V range: < 0.2% ***** Input impedance R_i >40 k... 100 k
8	PSEL	AI	Set power value	0...10 V or. 0...5 V correspond to 0..100% of P_{Nom}	
9	VMON	AO	Actual voltage	0...10 V or. 0...5 V correspond to 0..100% of U_{Nom}	Accuracy 0-5 V range: < 0.4% ***** Accuracy 0-10 V range: < 0.2% ***** at $I_{Max} = +2$ mA Short-circuit-proof against AGND
10	CMON	AO	Actual current	0...10 V or. 0...5 V correspond to 0..100% of I_{Nom}	
11	AGND	POT	Analog ground		For -SEL, -MON, VREF signals
12	R-ACTIVE	DI	R mode on / off	On = LOW, $U_{Low} < 1$ V Off = HIGH, $U_{High} > 4$ V Off = Open	Voltage range = 0...30 V $I_{Max} = -1$ mA bei 5 V U_{LOW} to HIGH typ. = 3 V Rec'd sender: Open collector against DGND
13	REM-SB	DI	DC output OFF (DC output ON) (ACK alarms ****)	Off = LOW, $U_{Low} < 1$ V On = HIGH, $U_{High} > 4$ V On = Open	Voltage range = 0...30 V $I_{Max} = +1$ mA at 5 V Rec'd sender: Open collector against DGND
14	ALARMS 2	DO	Overvoltage alarm Overcurrent alarm Overpower alarm	Alarm = HIGH, $U_{High} > 4$ V No alarm = LOW, $U_{Low} < 1$ V	Quasi open collector with pull-up against V_{cc} ** With 5 V on the pin max. flow +1 mA $I_{Max} = -10$ mA at $U_{CE} = 0,3$ V, $U_{Max} = 30$ V Short-circuit-proof against DGND
15	STATUS***	DO	Constant voltage regulation active DC output	CV = LOW, $U_{Low} < 1$ V CC/CP/CR = HIGH, $U_{High} > 4$ V On = LOW, $U_{Low} < 1$ V Off = HIGH, $U_{High} > 4$ V	

* AI = Analog Input, AO = Analog Output, DI = Digital Input, DO = Digital Output, POT = Potential

** Internal V_{cc} approx. 10 V

*** Only one of both signals possible, see section 3.4.3.1

**** Only during remote control

***** The error of an analog input/output adds to the general error of the related value on the DC output of the device

3.5.4.5 Overview of the Sub-D Socket

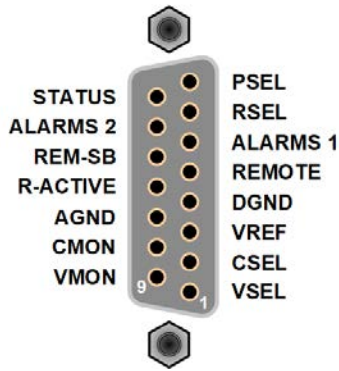

3.5.4.6 Simplified diagram of the pins

	<p>Digital Input (DI)</p> <p>The DI is internally pulled up and thus it requires to use a contact with low resistance (relay, switch, contactor etc.) in order to clearly pull the signal down to DGND.</p>		<p>Analog Input (AI)</p> <p>High resistance input (impedance >40 k....100 kΩ) for an OA circuit.</p>
	<p>Digital Output (DO)</p> <p>A quasi open collector, realised as high resistance pull-up against the internal supply. The design doesn't allow the pin to be loaded, but to switch signals by sinking current.</p>		<p>Analog Output (AO)</p> <p>Output from an OA circuit, low impedance. See specifications table above.</p>

3.5.4.7 Application examples

a) Switching the DC output with pin REM-SB

A digital output, e.g. from a PLC, may be unable to cleanly pull down the pin as it may not be of low enough resistance. Check the specification of the controlling application. Also see pin diagrams above.

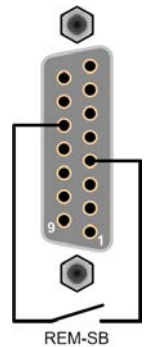

In remote control, pin REM-SB is used to switch the DC output of the device on and off. This function is also available without remote control being active and can on the one hand block the DC output from being switched on in manual or digital remote control and on the other hand the pin can switch the DC output on or off, but not standalone. See below at “Remote control has not been activated”.

It's recommended that a low resistance contact such as a switch, relay or transistor is used to switch the pin to ground (DGND).

Following situations can occur:

- **Remote control has been activated**

During remote control via analog interface, only pin REM-SB determines the states of the DC output, according to the levels definitions in 3.5.4.4. The logical function and the default levels can be inverted by a parameter in the setup menu of the device. See 3.4.3.1.

If the pin is unconnected or the connected contact is open, the pin will be HIGH. With parameter “Analog interface Rem-SB” being set to “normal”, it requests “DC output on”. So when activating remote control, the DC output will instantly switch on.

• **Remote control isn't active**

In this mode of operation pin REM-SB can serve as lock, preventing the DC output from being switched on by any means. This results in following possible situations:

DC output	+	Level on pin REM-SB	+	Parameter „Analog interface Rem-SB“	→	Behaviour
is off	+	HIGH	+	Normal	→	The DC output isn't locked. It can be switched on by pushbutton "On/Off" (front panel) or via command from digital interface.
		LOW	+	Inverted		
	+	HIGH	+	Inverted	→	The DC output locked. It can't be switched on by pushbutton "On/Off" (front panel) or via command from digital interface. When trying to switch on, a popup in the display resp. an error message will be generated.
		LOW	+	Normal		

In case the DC output is already switched on, toggling the pin will switch the DC output off, similar to what it does in analog remote control:

DC output	+	Level on pin REM-SB	+	Parameter „Analog interface Rem-SB“	→	Behaviour
is on	+	HIGH	+	Normal	→	The DC output remains on, nothing is locked. It can be switched on or off by pushbutton or digital command.
		LOW	+	Inverted		
	+	HIGH	+	Inverted	→	The DC output will be switched off and locked. Later it can be switched on again by toggling the pin. During lock, pushbutton or digital command can delete the request to switch on by pin.
		LOW	+	Normal		

b) Remote control of current and power

Requires remote control to be activated (Pin REMOTE = LOW)

The set values PSEL and CSEL are generated from, for example, the reference voltage VREF, using potentiometers for each. Hence the power supply can selectively work in current limiting or power limiting mode. According to the specification of max. 5 mA for the VREF output, potentiometers of at least 10 kΩ must be used.

The voltage set value VSEL is directly connected to VREF and will thus be permanently 100%.

If the control voltage is fed in from an external source it's necessary to consider the input voltage ranges for set values (0...5 V oder 0...10 V).

Use of the input voltage range 0...5 V for 0...100% set value halves the effective resolution.

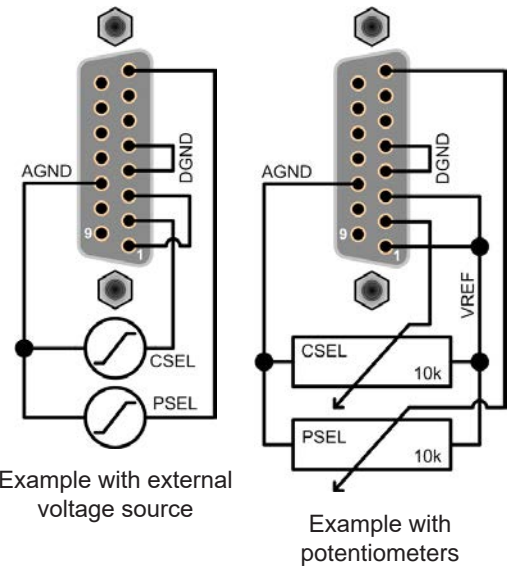

c) Reading actual values

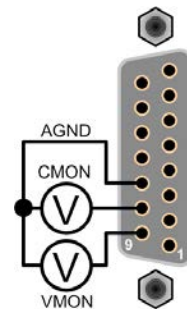

The AI provides the DC output values as current and voltage monitor. These can be read using a standard multimeter or similar.



3.6 Alarms and monitoring

3.6.1 Definition of terms

There is a clear distinction between device alarms (see „3.3. Alarm conditions“) such as overvoltage protection or overheating protection, and user defined events such as **OVD** (overvoltage detection). Whilst device alarms serve to protect the device by initially switching off the DC output, user defined events can switch off the DC output (Action = ALARM), but can also simply give an acoustic signal to make the user aware. The actions driven by user defined events can be selected:

Action	Impact	Example
NONE	User defined event is disabled.	
SIGNAL	On reaching the condition which triggers the event, the action SIGNAL will show a text message in the status area of the display.	
WARNING	On reaching the condition which triggers the event, the action WARNING will show a text message in the status area of the display and pop up an additional warning message.	
ALARM	On reaching the condition which triggers the event, the action ALARM will show a text message in the status area of the display with an additional alarm pop-up, and additionally emit an acoustic signal (if activated). Furthermore the DC output is switched off. Certain device alarms are also signalled to the analog interface or can be queried via the digital interface.	

3.6.2 Device alarm and event handling

A device alarm incident will usually lead to DC output switch-off, the appearance of a pop-up in the middle of the display and, if activated, an acoustic signal to make the user aware. An alarm must always be acknowledged.

► **How to acknowledge an alarm in the display (during manual control)**

1. If the alarm is indicated as a pop-up, tap **OK**.
2. If the alarm has already been acknowledged, but is still displayed in the status area, then first tap the status area to display the pop-up, and then acknowledge with **OK**.



In order to acknowledge an alarm during analog remote control, see „3.5.4.3. Acknowledging device alarms“. To acknowledge in digital remote, refer to the external documentation “Programming ModBus & SCPI”.

Some device alarms are configurable:

Short	Long	Description	Range	Indication
OVP	OverVoltage Protection	Triggers an alarm if the DC output voltage reaches the defined threshold. The DC output will be switched off.	0 V...1.1*U _{Nom}	Display, analog & digital interface
OCP	OverCurrent Protection	Triggers an alarm if the DC output current reaches the defined threshold. The DC output will be switched off.	0 A...1.1*I _{Nom}	
OPP	OverPower Protection	Triggers an alarm if the DC output power reaches the defined threshold. The DC output will be switched off.	0 W...1.1*P _{Nom}	

These device alarms can't be configured and are based on hardware:

Short	Long	Description	Indication
PF	Power Fail	AC supply over- or undervoltage. Triggers an alarm if the AC supply is out of specification or when the device is cut from supply, for example when switching it off with the power switch. The DC output will be switched off which could be only temporarily, depending on the situation and setting “DC output after PF alarm” (see 3.4.3.1).	Display, analog & digital interface
OT	OverTemperature	Triggers an alarm if the internal temperature reaches a certain limit. The DC output will be switched off which could be only temporarily, depending on the setting “DC output after OT alarm” (see 3.4.3.1).	Display, analog & digital interface

Short	Long	Description	Indication
MSP	Master-Slave Protection	Triggers an alarm if the master unit loses contact to any slave unit. The DC output will be switched off. The alarm can be cleared by reinitializing the MS system.	Display, digital interface

► How to configure the device alarms



1. While the DC output is switched off tap the touch area  on the main screen.
2. On the right side tap the arrow to select “2. Protect”.
3. Set the limits for the equipment alarm relevant to your application if the default value of 110% is unsuitable.



The set values can be entered using the ten-key tab. This will appear after tapping the touch area “Direct input”.

The user also has the possibility of selecting whether an additional acoustic signal will be sounded if an alarm or user defined event occurs.

► How to configure the alarm sound (also see “3.4.3. Configuration via MENU”)

1. While the DC output is switched off tap the touch area  on the main screen
2. In the menu page, tap “HMI Settings”
3. In the following menu page, tap “Alarm Sound”
4. In the settings page tap on the symbol to either enable or disable the alarm sound and confirm with .

3.6.2.1 User defined events

The monitoring functions of the device can be configured for user defined events. By default, events are deactivated (action = NONE). Contrary to device alarms, the events only work while the DC output is switched on. It means, for instance, that you can't detect undervoltage (UVD) anymore after switching the DC output off and the voltage is still sinking.





The following events can be configured independently and can, in each case, trigger the actions NONE, SIGNAL, WARNING or ALARM.

Event	Meaning	Description	Range
UVD	UnderVoltage Detection	Triggers an event if the output voltage falls below the defined threshold.	0 V...U _{Nom}
OVD	OverVoltage Detection	Triggers an event if the output voltage exceeds the defined threshold.	0 V...U _{Nom}
UCD	UnderCurrent Detection	Triggers an event if the output current falls below the defined threshold.	0 A...I _{Nom}
OCD	OverCurrent Detection	Triggers an event if the output current exceeds the defined threshold.	0 A...I _{Nom}
OPD	OverPower Detection	Triggers an event if the output power exceeds the defined threshold.	0 W...P _{Nom}



These events should not be confused with alarms such as OT and OVP which are for device protection. User defined events can, however, if set to action ALARM, switch off the DC output and thus protect the load, like a sensitive electronic application.

► How to configure user defined events

1. While the DC output is switched off tap the touch area  on the main screen.
2. On the right side tap the arrows   to select “4.1 Event U” or “4.2 Event I” or “4.3 Event P”.
3. Set the monitoring limits with the left hand rotary knob and the triggered action with the right hand knob relevant to the application (also see “3.6.1. Definition of terms”).
4. Accept the settings with .



User events are an integral part of the actual user profile. Thus, if another user profile or the default profile is selected and used, the events could either be differently configured or not at all.





The set values can be entered using the ten-key tab. This will appear by tapping the touch area "Direct input".

3.7 Control panel (HMI) lock

In order to avoid the accidental alteration of a value during manual operation the rotary knobs or the touchscreen can be locked so that no alteration of values will be accepted without prior unlocking.

► How to lock the HMI

1. In the main page, tap the lock symbol  (upper right corner).
2. In the settings page "HMI Lock" you are then asked to choose between a complete HMI ("Lock all") lock or one where the On/Off button is still usable ("ON/OFF possible"), resp. choose to activate the additional PIN ("Enable PIN"). The device would later request to enter this PIN every time you want to unlock the HMI, until the PIN is deactivated again.
3. Activate the lock with . The status "Locked" as shown in the figure to the right.

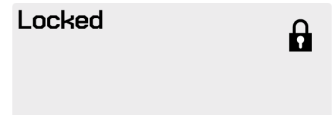

If an attempt is made to alter something whilst the HMI is locked, a requester appears in the display asking if the lock should be disabled.

► How to unlock the HMI

1. Tap any part of the touchscreen of the locked HMI, or turn one of the rotary knobs or press the button "On/Off" (only in "Lock all" situation).
2. This request pop-up will appear: .
3. Unlock the HMI by tapping on "Tap to unlock" within 5 seconds, otherwise the pop-up will disappear and the HMI remains locked. In case the additional PIN code lock has been activated in the menu "HMI Lock", another requester will pop up, asking you to enter the PIN before it finally unlocks the HMI.

3.8 Limits lock

In order to avoid the alteration of the adjustment limits (also see „3.4.4. Adjustment limits“) by an unprivileged user, the screen with the adjustment limit settings ("Limits") can be locked by a PIN code. The menu pages "3.Limits" in SETTINGS and "Profiles" in MENU will then become inaccessible until the lock is removed by entering the correct PIN or in case it has been forgotten, by resetting the device as last resort.

► How to lock the "Limits"

1. While the DC output is switched off, tap the touch area  on the main screen.
2. In the menu tap "Limits Lock".
3. In the menu tap on "HMI Setup" and then on "Limits Lock".



The same PIN as with the HMI lock is used here. It should be set before activating the Limits lock. See „3.7. Control panel (HMI) lock“

4. Activate the lock by leaving the settings page with .



Be careful to enable the lock if you are unsure what PIN is currently set. In doubt use ESC to exit the menu page. In menu page "HMI Lock" you can define a different PIN, but not without entering the old one.

► How to unlock the limits settings

1. While the DC output is switched off, tap the touch area  on the main screen.
2. In the menu tap on “**HMI Setup**” and then on “**Limits Lock**”.
3. In the next page tap on touch area “**Unlock**” and then you will be asked to enter the 4-digit PIN.
4. Deactivate the lock by entering the correct PIN and submitting with ENTER.



3.9 Loading and saving a user profile

The menu “**Profiles**” serves to select between a default profile and up to 5 user profiles. A profile is a collection of all settings and set values. Upon delivery, or after a reset, all 6 profiles have the same settings and all set values are 0. If the user changes settings or sets target values then these create a working profile which can be saved to one of the 5 user profiles. These profiles or the default one can then be switched. The default profile is read-only.

The purpose of a profile is to load a set of set values, settings limits and monitoring thresholds quickly without having to readjust these. As all HMI settings are saved in the profile, including language, a profile change can also be accompanied by a change in HMI language.

On calling up the menu page and selecting a profile the most important settings can be seen, but not changed.

► How to save the current values and settings as a user profile:

1. Tap the touch area  on the main screen
2. In the menu page, tap .
3. In the selection screen (right) choose between user profile 1-5 in which the settings are to be saved. The profile will then be displayed and the values can be checked, but not changed.
4. Save using the touch area .



3.10 The function generator

3.10.1 Introduction

The built-in **function generator** (short: **FG**) is able to create various signal forms and apply these to the set value of voltage or current.

The standard functions are based on an **arbitrary generator** and directly accessible and configurable using manual control. For remote control, the fully customizable arbitrary generator replicates the functions with sequences containing 8 parameters each.

The following functions are retrievable, configurable and controllable:

Function	Short description
Sine wave	Sine wave generation with adjustable amplitude, offset and frequency
Triangle	Triangular wave signal generation with adjustable amplitude, offset, rise and fall times
Rectangular	Rectangular wave signal generation with adjustable amplitude, offset and duty cycle
Trapezoid	Trapezoidal wave signal generation with adjustable amplitude, offset, rise time, pulse time, fall time, idle time
DIN 40839	Simulated automobile engine start curve according to DIN 40839 / EN ISO 7637, split into 5 curve sequences, each with a start voltage, final voltage and time
Arbitrary	Generation of a process with up to 100 freely configurable curve points, each with a start and end value (AC/DC), start and end frequency, phase angle and total duration
Ramp	Generation of a linear rise or fall ramp with start and end values and time before and after the ramp
UI, IU	XY generator, USB stick loadable current or voltage curve (value table, CSV)
PV, FC	Functions to simulate a solar panel (PV function) or fuel cells (FC function), both with table calculation based upon adjustable parameters, also for EN 50530



Whilst R mode is activated, access to the function generator isn't available.

3.10.2 General

3.10.2.1 Limitations

The function generator isn't accessible, neither for manual access, nor for remote control, if

- master-slave mode has been activated and the device was configured as slave.
- resistance mode (R/I adjustment, also called UIR) is active.

3.10.2.2 Principle

The power supply unit can't be considered as high power function generator, because its power stages are only post-connected to the FG. Thus the typical characteristics of a voltage and current source remain. Rise and fall times, caused by capacitor charge/discharge, affect the resulting signal on the DC output. While the FG is able to generate a sine wave with 1000 Hz or more, the power supply will never be able to follow the generated signal 1:1.

Depiction of principle:

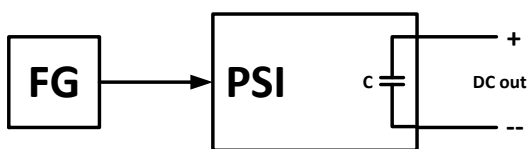

Affect of the power supply on functions:

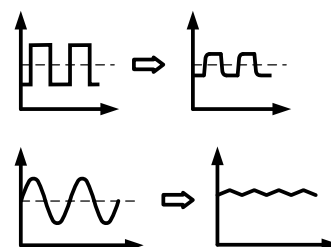

The resulting wave on the DC output heavily depends on the frequency resp. period of the selected wave, its amplitude and also the output capacitance. The effects of the power stages on the wave can only be partially compensated. A high-speed modification, like offered with **option HS** (see „1.9.5. Options“), can help to decrease rise and fall times. It has a positive impact on periodic functions like rectangle or sine wave. Alternatively, the resulting wave form on the DC output can also be improved by attaching additional load (fixed & ohmic or variable & electronic).

3.10.2.3 Resolution

Amplitudes generated by the arbitrary generator have an effective resolution of approx. 52428 steps. If the amplitude is very low and the time long, the device would generate less steps and set multiple identical values after another, generating a staircase effect. It's furthermore not possible to generate every possible combination of time and a varying amplitude (slope).

3.10.2.4 Possible technical complications

Operation of switching mode power supplies as a voltage source can, when applying a function to the output voltage, lead to damage of the output capacitors due to continuous charging/discharging which causes overheating. Furthermore the actual voltage progression may differ from what's expected.

3.10.2.5 Minimum slope / maximum ramp time

When using a rising or falling offset (i.e. DC part) at functions like ramp, trapezoid, triangle and even sine wave, a minimum slope, calculated from the rated values of voltage or current, is required or else the adjusted settings would be neglected by the device. Calculating the minimum slope can help to determine if a certain ramp over time can be achieved by the device or not. Example: model PSI 9080-170 is going to be used, with 80 V and 170 A rating. **Formula: minimum slope = 0.000725 * rated value / s.** For the example model it results in $\Delta U/\Delta t$ of 58 mV/s and $\Delta I/\Delta t$ of 123 mA/s. The maximum time which can be achieved with the minimum slope then calculates as approximately 1379 seconds according to formula $t_{Max} = \text{rated value} / \text{min. slope}$.

3.10.3 Method of operation

In order to understand how the function generator works and how the value settings interact, the following should be noted:

The device always works with the three set values U, I and P, also in function generator mode.

The selected function can be used on one of both the values U or I, the other two are then constants and have a limiting effect. That means if, for example, a voltage of 10 V is set for the DC output, a load is connected and a sine wave function should operate on the current with an amplitude of 20 A and offset 20 A, then the function generator will create a sine wave progression of current between 0 A (min) and 40 A (max), which will result in an output power between 0 W (min) and 400 W (max). The output power, however, is limited to its set value. If this were 300 W then, in this case, the current would be limited to 30 A and, if clamped to an oscilloscope, it would be seen to be truncated at 30 A and never reach the peak of 40 A.

Master-slave systems have further characteristics which have to be considered:



At the end of the configuration of every standard function you are requested to set up global set values, the so-called "U/I/P limits". These limits are transferred to all slave units of master-slave systems. It's recommended to carefully configure them so the MS system can work as expected and the slaves wouldn't impact the function run in a negative way.

3.10.4 Manual operation

3.10.4.1 Function selection and control



Via the touch screen one of the functions described in 3.10.1 can be selected, configured and controlled. This is only possible when the DC output is switched off.



► How to select a function and adjust parameters

1. While the DC output is switched off tap the touch area  on the main screen.

2. In the menu tap on the touch area  and then on the desired function.
Note: this touch area is locked if R mode (adjustable resistance) is activated.

3. Depending on the choice of function there follows a request to which value the function generator is going to be applied:  or .

4. Adjust the parameters as you desire, like offset, amplitude and frequency for a sine wave, for example.

5. Adjust the overall limits of voltage, current and power, which you can access with touch area .

Setting the various functions is described below. After setting it up, the function can be loaded.

► How to load a function

1. After setting the values for the required signal generation, tap on the touch area .

The device will then load the data into the internal controller and changes the display. Shortly afterwards the static values are set (power and voltage or current), the DC output is switched on and the touch area **START** enabled. Only then can the function be started.

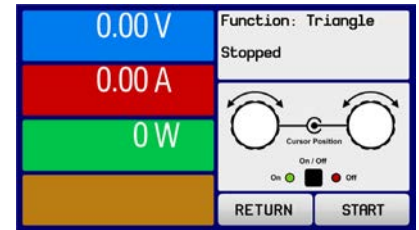

The static values are applied to the DC output immediately after loading the function, because it switches the DC output on automatically in order to set the start situation. They represent start and end values for the progress of the function, so that it doesn't need to start from 0. Only exception: when applying a function to the current (I), there is no adjustable static current value, so the function would always start from 0 A.

► How to start and stop a function

1. The function can be started either by tapping **START** or pushing the "On/Off" button, if the DC output is currently switched off. The function then starts immediately. In case START is used while the DC output is still switched off, it will be switched on automatically.
2. The function can be **stopped** either by tapping **STOP** or operating the "On/Off" button. However, there is a difference:
 - a) The **STOP** button stops only the function, the DC output remains ON with the static values.
 - b) The "On/Off" button stops the function and switches off the DC output.



Any device alarm (overvoltage, overtemperature etc.), protection (OPP, OCP) or event with action = Alarm stops the function progress automatically, switches off the DC output and reports the alarm.

3.10.5 Sine wave function

The following parameters can be configured for a sine wave function:

Value	Range	Description
I(A), U(A)	0...(Nominal value - (Offs)) of U, I	A = Amplitude of the signal to be generated
I(Offs), U(Offs)	(A)...(Nominal value - (A)) of U, I	Offs = Offset, based on the zero point of the mathematical sine curve, may not be smaller than the amplitude.
f (1/t)	1...10000 Hz	Static frequency of the signal to be generated

Schematic diagram:

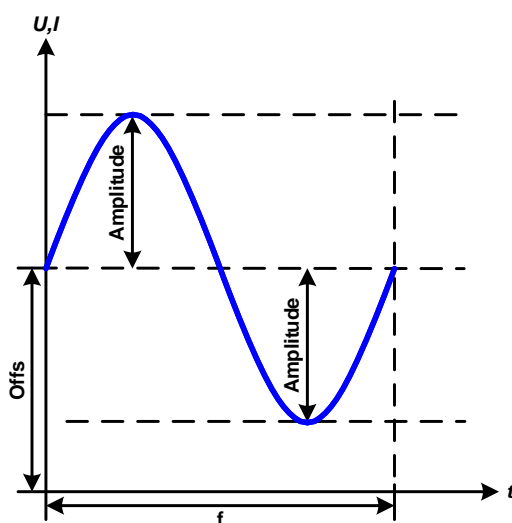

Application and result:

A normal sine wave signal is generated and applied to the selected set value, e.g. voltage (U). At a constant load resistance, the output voltage and thus also the output current will follow a sine wave.

For calculating the maximum power output the amplitude and offset values for the current have to be added.

Example: an output voltage of 100 V is set together with sin(I) with an amplitude of 30 A and an offset of 50 A. The resulting maximum power output is then achieved at the highest point of the sine wave and is $(30 \text{ A} + 50 \text{ A}) * 100 \text{ V} = 8000 \text{ W}$.

3.10.6 Triangular function

The following parameters can be configured for a triangular wave function:

Value	Range	Description
I(A), U(A)	0...(Nominal value - (Offs)) of U, I	A = Amplitude of the signal to be generated
I(Offs), U(Offs)	0...(Nominal value - (A)) of U, I	Offs = Offset, based on the foot of the triangular wave
t1	0.1 ms...36000 s	Rising edge time Δt of the triangular wave signal
t2	0.1 ms...36000 s	Falling edge time Δt of the triangular wave signal

Schematic diagram:

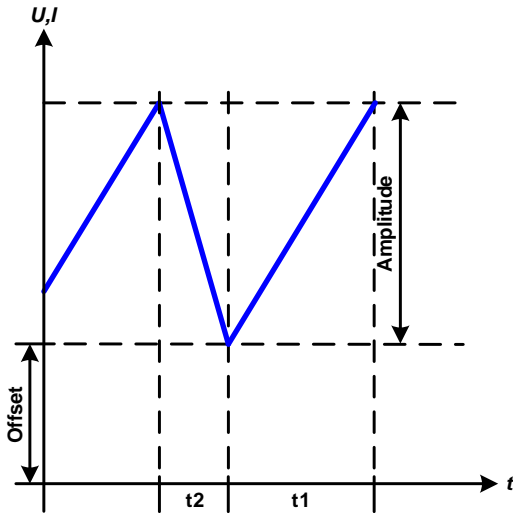

Application and result:

A triangular wave signal for output current (only effective in current limiting) or output voltage is generated. The positive and negative slope times can be set independently.

The offset shifts the signal on the Y-axis.

The sum of the intervals t1 and t2 gives the cycle time and its reciprocal is the frequency.

Example: a frequency of 10 Hz is required and would lead to periodic duration of 100 ms. This 100 ms can be freely allocated to t1 and t2, e.g. 50 ms:50 ms (isosceles triangle) or 99.9 ms:0.1 ms (right-angled triangle or sawtooth).

3.10.7 Rectangular function

The following parameters can be configured for a rectangular wave function:

Value	Range	Description
I(A), U(A)	0...(Nominal value - (Offs)) of U, I	A = Amplitude of the signal to be generated
I(Offs), U(Offs)	0...(Nominal value - (A)) of U, I	Offs = Offset, based on the foot of the rectangular wave
t1	0.1 ms...36000 s	Time (pulse width) of the upper level (amplitude)
t2	0.1 ms...36000 s	Time (pause width) of the lower level (offset)

Schematic diagram:

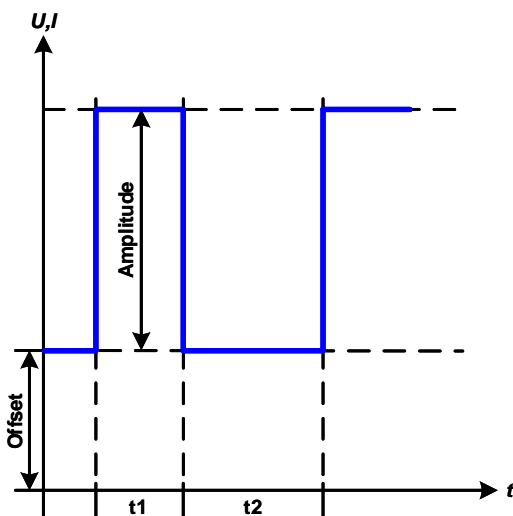

Application and result:

A rectangular or square wave signal for input current (direct) or input voltage (indirect) is generated. The intervals t1 and t2 define how long the value of the amplitude (pulse) and how long the value of the offset (pause) are effective.

The offset shifts the signal on the Y axis.

Intervals t1 and t2 can be used to define a duty cycle. The sum of t1 and t2 gives the period and its reciprocal is the frequency.

Example: a rectangular wave signal of 25 Hz and a duty cycle of 80% are required. The sum of t1 and t2, the period, is $1/25 \text{ Hz} = 40 \text{ ms}$. For a duty cycle of 80% the pulse time (t1) is $40 \text{ ms} \cdot 0.8 = 32 \text{ ms}$ and the pause time (t2) is 8 ms

3.10.8 Trapezoidal function

The following parameters can be configured for a trapezoidal curve function:

Value	Range	Description
I(A), U(A)	0...(Nominal value - (Offs)) of U, I	A = Amplitude of the signal to be generated
I(Offs), U(Offs)	0...(Nominal value - (A)) of U, I	Offs = Offset, based on the foot of the trapezium
t1	0.1 ms...36000 s	Time for the positive slope of the trapezoidal wave signal.
t2	0.1 ms...36000 s	Time for the top value of the trapezoidal wave signal.
t3	0.1 ms...36000 s	Time for the negative slope of the trapezoidal wave signal.
t4	0.1 ms...36000 s	Time for the base value (offset) of the trapezoidal wave signal

Schematic diagram:

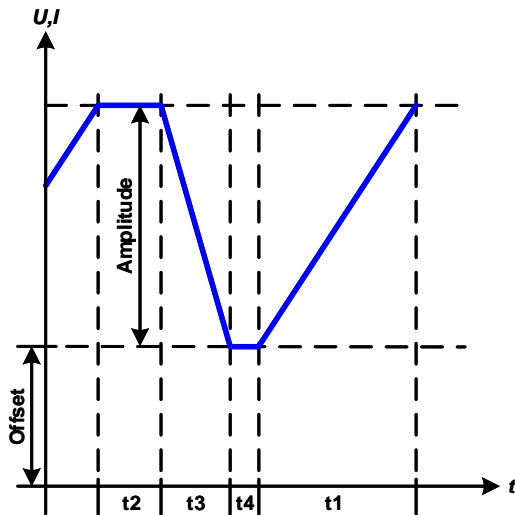

Application and result:

Here a trapezoidal signal can be applied to a set value of U or I. The slopes of the trapezium can be varied by setting different times for rise and fall.

The periodic duration and repetition frequency are the result of four time elements. With suitable settings the trapezium can be deformed to a triangular or rectangular wave. It has, therefore, universal use.

3.10.9 DIN 40839 function

This function is based on the curve defined in DIN 40839 / EN ISO 7637 (test impulse 4), and is only applicable to voltage. It shall replicate the progress of automobile battery voltage during engine starting. The curve is divided into 5 sequence points (see diagram below) which each have the same parameters. The standard values from the DIN are set already as default values for the five point.

The following parameters can be configured for the DIN40839 function:

Value	Range	Seq	Description
Ustart	0...Nominal value of U	1-5	Start voltage of the ramp
Uend	0...Nominal value of U	1-5	End voltage of the ramp
Seq.time	0.1 ms...36000 s	1-5	Time of the ramp
Seq.cycles	∞ or 1...999	-	Number of repetitions of the entire curve
Time t1	0.1 ms...36000 s	-	Time after cycle before repetition (cycle <> 1)

Schematic diagram:

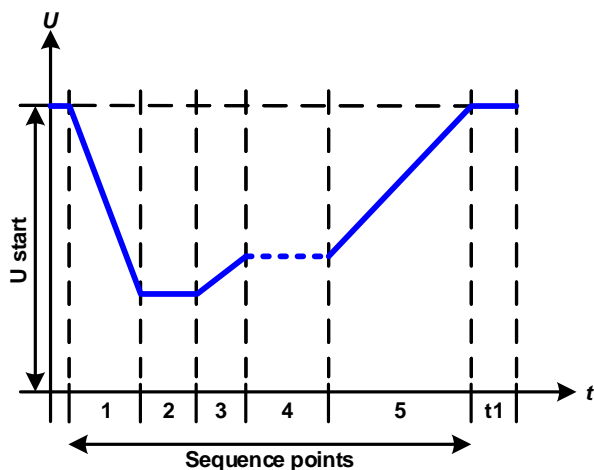

Application and result:

The function isn't suitable for standalone operation of a power supply, but optimal for a power supply operation in conjunction with an electronic load, for example one from ELR 9000 series. The load acts as a sink for the rapid fall of the output voltage of the power supply enabling the output voltage progress to follow the DIN curve.

The curve conforms to test impulse 4 of the DIN. With suitable settings, other test impulses can be simulated. If the curve in sequence point 4 should be a sine wave, then these 5 points would have to be transferred to the arbitrary generator.

3.10.10 Arbitrary function

The arbitrary, i. e. freely definable function offers the user a wider scope. There are 99 freely configurable sequence points available. While all have the same set of parameters, they can be configured differently so that a complex function process can be created. The 99 sequence points or a part of them can run one after another in a sequence point block and this block can then be repeated up to 999 times or infinitely. A sequence point or sequence point block is always assigned to either current or voltage, thus a mix of assignment to current or voltage isn't possible.

The arbitrary curve overlays a linear progression (DC) with a sine curve (AC), whose amplitude and frequency are shaped between start and end values. If the start frequency (f_s) = end frequency (f_e) = 0 Hz, the AC values have no impact and only the DC part is effective. Each sequence point is allocated a time in which the AC/DC curve from start to finish will be generated.

The following parameters can be configured for each sequence in the arbitrary function (the table lists parameters for current, for voltage it would be U_s , U_e etc.)

Value	Range	Description
Is(AC)	0...50% Nominal value of I	Start amplitude of the AC part of the curve
Ie(AC)	0...50% Nominal value of I	End amplitude of the AC part of the curve
fs(1/T)	0 Hz...10000 Hz	Start frequency of the AC part of the curve
fe(1/T)	0 Hz...10000 Hz	End frequency of the AC part of the curve
Angle	0°...359°	Start angle of the AC part of the curve
Is(DC)	Is(AC)...(Nominal value - Is(AC)) of I	Start value of the DC part of the curve
Ie(DC)	Ie(AC)...(Nominal value - Ie(AC)) of I	End value of the DC part of the curve
Seq.time	0.1 ms...36000 s	Time for the selected sequence



The sequence time (seq. time) and the start and end frequency are related. The minimum value for $\Delta f/s$ is 9.3. Thus, for example, a setting of $f_s = 1$ Hz, $f_e = 11$ Hz and Seq.time = 5 s would not be accepted as $\Delta f/s$ is only 2. A seq. time of 1 s would be accepted, or, if the time remains at 5 s, then $f_e = 51$ Hz must be set.



The amplitude change between start and end is related to the sequence time. A minimal change over an extended time isn't possible and in such a case the device will report an inapplicable setting.

After the settings for the selected sequence point are accepted with SAVE, further points can be configured. If the button NEXT is touched a second settings screen appears in which global settings for all 99 sequence points are displayed.

The following parameters can be set for the total run of an arbitrary function:

Value	Range	Description
Start seq.	1...End seq.	First sequence point in the block
End seq.	Start seq...99	Last sequence point in the block
Seq. Cycles	∞ or 1...999	Number of cycles of the block.

Schematic diagram:

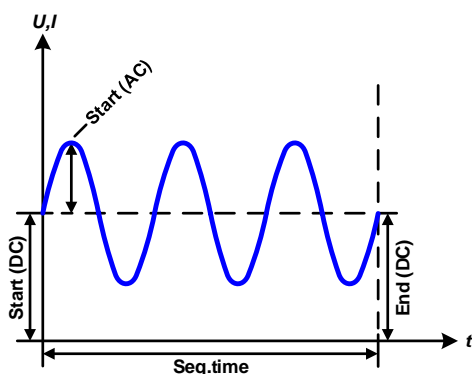

Applications and results:

Example 1

Focusing 1 cycle of 1 sequence point:

DC values for start and end are the same, also the AC amplitude. With a frequency >0 a sine wave progression of the set value is generated with a defined amplitude, frequency and offset (DC value at start and end).

The number of sine waves per cycle depend on the sequence point time and the frequency. If the time were 1 s and the frequency 1 Hz, there would be exactly 1 sine wave. If the time were 0.5 s at the same frequency, there would only be a half sine wave.

Schematic diagram:

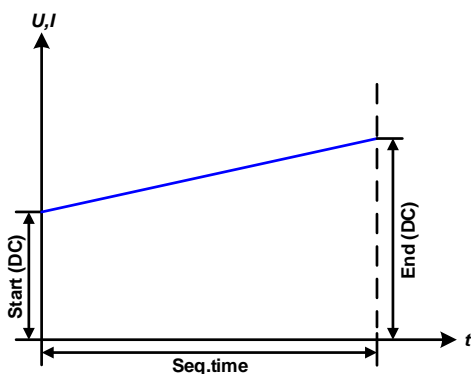
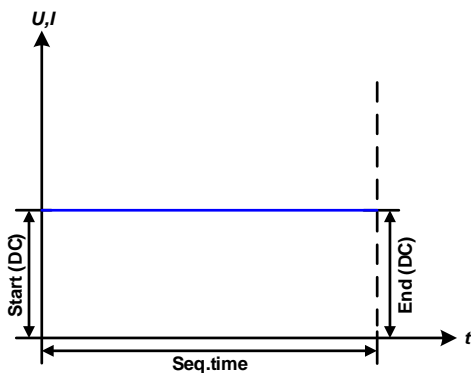
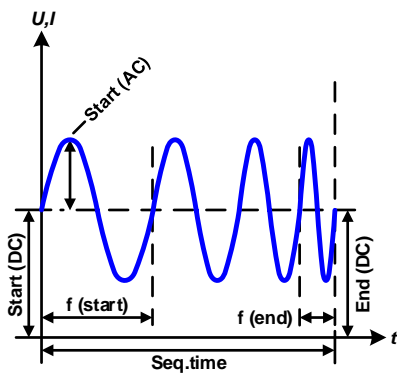
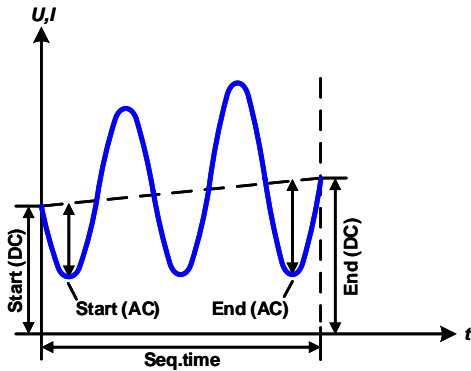
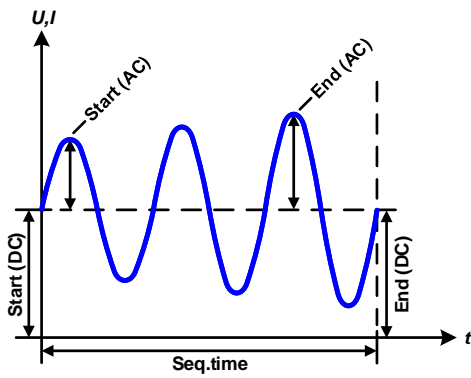

Applications and results:

Example 2

Focusing 1 cycle of 1 sequence point:

The DC values at start and end are the same but the AC (amplitude) not. The end value is higher than the start so that the amplitude increases with each new half sine wave continuously through the sequence. This, of course, only if the sequence time and frequency allow for multiple waves to be created. e.g. for $f=1$ Hz and Seq. time = 3 s, three complete waves would be generated (for angle = 0°) and reciprocally the same for $f=3$ s and Seq. time=1 s.

Example 3

Focusing 1 cycle of 1 sequence point:

The DC values at start and end are unequal, as are also the AC values. In both cases the end value is higher than the start so that the offset increases from start to end (DC) and the amplitude also with each new half sine wave.

Additionally the first sine wave starts with a negative half wave because the angle is set at 180° . The start angle can be shifted at will in 1° steps between 0° and 359° .

Example 4

Focusing 1 cycle of 1 sequence point:

Similar to example 1 but with another end frequency. Here this is shown as higher than the start frequency. This impacts the period of the sine waves such that each new wave will be shorter over the total span of the sequence time.

Example 5

Focusing 1 cycle of 1 sequence point:

Similar to example 1 but with a start and end frequency of 0 Hz. Without a frequency no sine wave part (AC) will be created and only the DC settings will be effective. A ramp with a horizontal progression is generated.

Example 6

Focusing 1 cycle of 1 sequence point:

Similar to example 1 but with a start and end frequency of 0 Hz. Without a frequency no sine wave part (AC) will be created and only the DC settings will be effective. Here start and end values are unequal and a steadily increasing ramp is generated.

By linking together a number of differently configured sequence points, complex progressions can be created. Smart configuration of the arbitrary generator can be used to match triangular, sine, rectangular or trapezoidal wave functions and thus, e.g. a sequence of rectangular waves with differing amplitudes or duty cycles could be produced.



Assignment to either U or I makes up to 99 sequence points available for either current or voltage but not a mix.

Schematic diagram:

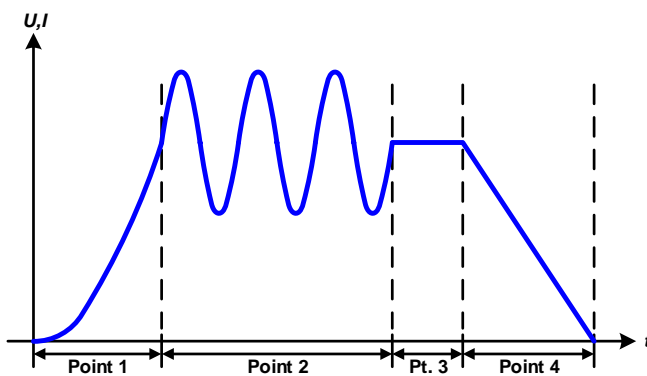
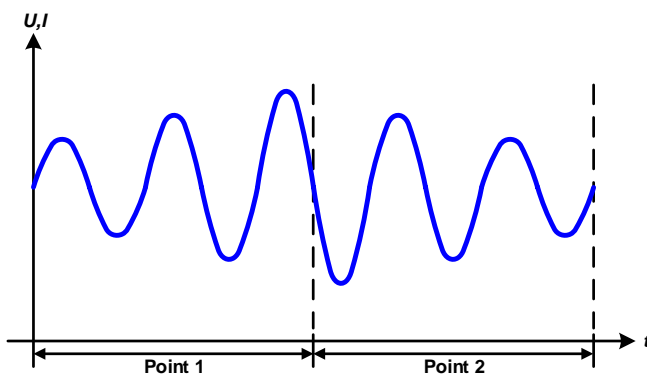
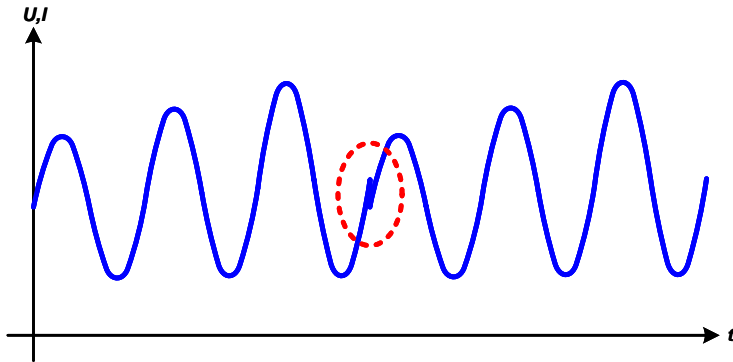

Applications and results:

Example 7

Focusing 2 cycles of 1 sequence point:

A sequence point, configured as in example 3, is run. Because the settings demand that the end offset (DC) is higher than the start, the second cycle will revert to the same start level as the first, regardless of the values achieved at the end of the first run. This can produce a discontinuity in the total progression (marked in red) which may only be compensated with careful choice of settings.

Example 8

Focusing 1 cycle of 2 sequence points:

Two sequences run consecutively. The first generates a sine wave with increasing amplitude, the second with a decreasing amplitude. Together they produce a progression as shown left. In order to ensure that the maximum wave in the middle occurs only once, the first sequence must end with a positive half wave and the second start with a negative half wave as shown in the diagram..

Example 9

Focusing 1 cycle of 4 sequence points:

Point 1: 1/4th sine wave (angle = 270°)

Point 2: Three sine waves (ratio of frequency to sequence point time: 1:3)

Point 3: Horizontal ramp ($f = 0$)

Point 4: Falling ramp ($f = 0$)

3.10.10.1 Loading and saving the arbitrary function

The 99 sequence points of the arbitrary function, which can be manually configured with the control panel of the device and which are applicable either to voltage (U) or current (I), can be saved to or loaded from a common USB stick via the front side USB port. Generally, all 99 sequence points are saved or loaded using a text file of type CSV (semicolon separator), which represents a table of values.

In order to load a sequence table for the arbitrary generator, following requirements have to be met:

- The table must contain 99 row (100 are also accepted for compatibility to previous firmwares), with 8 subsequent values in 8 columns and must not have gaps
- The column separator (semicolon, comma) must be as selected by MENU parameter “USB file separator format”; it also defines the decimal separator (dot, comma)
- The files must be stored inside a folder called HMI_FILES which has to be in the root of the USB stick
- The file name must always start with WAVE_U or WAVE_I (not case-sensitive)
- All values in every row and column have to be within the specified range (see below)
- The columns in the table have to be in a defined order which must not be changed

Following value ranges are given for use in the table, related to the manual configuration of the arbitrary generator (column headers like in Excel):

Column	Parameter	Range
A	AC start amplitude	0...50% U or I
B	AC end amplitude	0...50% U or I
C	Start frequency	0...10000 Hz
D	End frequency	0...10000 Hz
E	AC start angle	0...359°
F	DC start offset	0...(Nominal value of U or I) - AC Start
G	DC end offset	0...(Nominal value of U or I) - AC End
H	Sequence point time in μ s	100...36.000.000.000 (36 billion μ s)

For details about the parameter and the arbitrary function refer to „3.10.10. Arbitrary function“.

Example CSV:



	A	B	C	D	E	F	G	H
1	20,00	30,00	5	5	90	50,00	50,00	50000000
2	30,00	20,00	5	5	90	50,00	50,00	30000000
3	0,00	0,00	0	0	0	0,00	0,00	1000
4	0,00	0,00	0	0	0	0,00	0,00	1000
5	0,00	0,00	0	0	0	0,00	0,00	1000
6	0,00	0,00	0	0	0	0,00	0,00	1000

The example shows that only the first two sequences are configured, while all others are set to default values. The table could be loaded as WAVE_U or WAVE_I when using, for example, the model PSI 9080-170 3U, because the values would fit both, voltage and current. The file naming, however, is unique. A filter prevents you from loading a WAVE_I file after you have selected “Arbitrary --> U” in the function generator menu. The file would not be listed all.

► How to load a sequence point table from an USB stick:

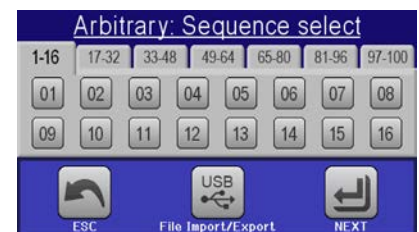
1. Do not plug the USB stick yet or remove it.
2. Access the function selection menu of the function generator with MENU -> Function Generator -> Arbitrary -> U/I, to see the main screen of sequence selector, as depicted to the right.



3. Tap touch area  File Import/Export, then  and follow the instructions on screen. If at least one valid files has been recognized (for file and path naming see above), the device will show a list of files to select from with .

4. Tap touch area  in the bottom right corner. The selected file is then checked and loaded, if valid. In case it's not valid, the device will show an error message. Then the file must be corrected and the steps repeated.

► How to save a sequence point table to an USB stick:

1. Do not plug the USB stick yet or remove it.
2. Access the function selection menu of the function generator via MENU -> Function Generator -> Arbitrary



3. Tap on **File Import/Export**, then **SAVE to USB**. The device will request you to plug the USB stick now.
4. After plugging it, the device will try to access the stick and find the folder HMI_FILES and read the content. If there are already WAVE_U or WAVE_I files present, they will be listed and you can either select one for overwriting with , otherwise select **-NEW FILE-** for a new file.



5. Finally save the sequence table with **SAVE to USB**.

3.10.11 Ramp function

The following parameters can be configured for a ramp function.

Value	Range	Description
Ustart / Istart	0...Nominal value of U, I	Start value (U,I)
Uend / Iend	0...Nominal value of U, I	End value (U, I)
t1	0,1 ms...36000 s	Time before ramp-up or ramp-down of the signal.
t2	0.1 ms...36000 s	Ramp-up or ramp-down time

Schematic diagram:

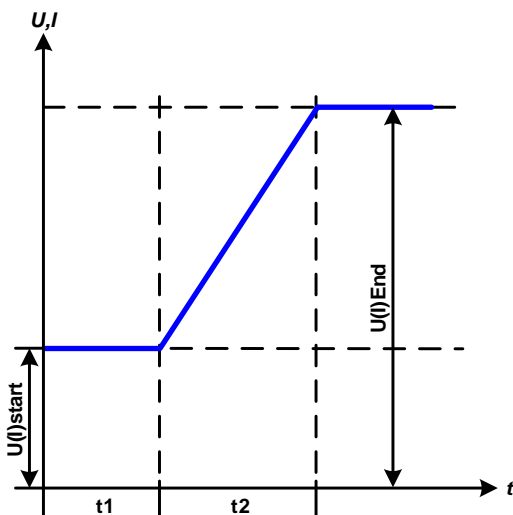

Application and result:

This function generates a rising or falling ramp between start and end values over the time t2. Time t1 creates a delay before the ramp starts.

The function runs once and stops at the end value. To have a repeating ramp, function Trapezoid would have to be used instead (see 3.10.8).

Important to consider are the static values of U and I which define the start levels at the beginning of the ramp. It's recommended that these values are set equal to those in Ustart/Istart, unless the load at the DC output should not be provided with voltage before the start of the ramp. In that case the static values should be set to zero.



10 hours after reaching the ramp end, the function will stop automatically (i.e. I = 0 A, in case the ramp was assigned to the current), unless it has been stopped manually before.

3.10.12 UI and IU table functions (XY table)

The UI and IU functions offer the user the possibility to set a DC output current dependant on the DC output voltage, or a DC output voltage dependant on the DC output current. The function is table driven with exactly 4096 values, which are distributed over the whole measured range of actual output voltage or output current in the range of 0...125% Unom or Inom. The table can either be uploaded from an USB stick through the front side USB port of the device or via remote control (ModBus protocol or SCPI). The functions are:

UI function: $U = f(I)$

IU function: $I = f(U)$

In the **UI function**, the equipment measuring circuit determines the level from 0 to maximum of the output current. For each of the 4096 possible values for output current a voltage value is maintained by the user in the UI table which can be any value between 0 and nominal value. The values uploaded from an USB stick will always be interpreted as voltage values even if the user calculated them as current values and incorrectly loaded them as an UI table. The UI function suits very good for the simulation of fuel cell characteristics.

In the **IU function** the assignment of the values is the other way round, the behaviour, however, the same.

Thus the behaviour of the load or the current and power consumption can be controlled with dependance on output voltage and step changes can be created.

The IU function suit very good for the simulation of solar panels in photovoltaics related tests.



Uploading of a table from an USB stick must use text files in CSV format (.csv). Plausibility is checked on loading (values not too high, number of values correct) and possible errors reported in which case the table will not be loaded.*



The 4096 values in the table are only checked for size and count. If all the values were to be graphically plotted, a curve would be created which could include significant step changes in current or voltage. That could lead to complications for connected loads if, for example, the internal current measurement in the power supply swings slightly so that the voltage jumps backwards and forwards between two values in the table, which, in the worst case, could be 0 V and the maximum voltage.

3.10.12.1 Loading UI and IU tables from USB stick

The so-called UI or IU value tables can be loaded from a file via a standard USB stick that is formatted as FAT32. In order to load the file, it has to meet following specifications:

- The file name always begins with IU or UI (not case-sensitive), depending on which of the two function you load the table for
- The file must be a text file of type Excel CSV (semicolon as separator) and must only contain one column with exactly 4096 values without gaps
- Values with decimal places must use decimal separator that matches the selection in the general setting “USB file separator format”, which also defines the decimal separator between dot and comma (US default should be dot)
- No value may exceed the nominal value of the device. For example, if you have an 80 V model and you are going to load a table with values for voltage, none of the 4096 values may be higher than 80 V (the adjustment limits from the device’s front panel do not apply here)
- The file(s) has/have to be put inside a folder named HMI_FILES in the root of the stick



If these specifications are not met, the device won’t accept the file and put out an error message in the display. Files with names beginning different to UI or IU are not recognized for this purpose. The USB stick may contain multiple UI/IU files with different names and list them for the selection of one.

► How to load an UI or IU table from an USB stick:

1. Do not plug the USB stick yet or pull it out if already plugged.
2. Open the function selection menu of the function manager with MENU -> Function Generator -> XY Table
3. In the next scree select the desired function with either „UI Table“ or „IU Table“.
4. Configure the global parameters for U, I and P, if necessary.



5. Tap touch area **LOAD from USB** and plug the USB stick when requested, in order to select one out of X compatible files from the drive. In case the file isn’t accepted, the device will report an error in the display and also tell what’s wrong with the file.
6. Once the file is accepted, you will be requested to remove the USB stick.



7. Submit and load the function with **LOAD** to start and control it as with other function (also see „3.10.4.1.

Function selection and control“).

3.10.13 Simple PV (photovoltaics) function

3.10.13.1 Preface

This function uses the standard XY generator to let the power supply simulate solar panels or solar cells with certain characteristics. The device calculates an IU table from four typical values.

While the function is running, the user can adjust a parameter "Irradiance" between 0% (darkness) and 100% (bright light) in 1% steps to simulate different light situations.

The most important characteristics of a solar cell are:

- the short-circuit current (I_{SC}), the maximum current at almost 0 V
- the open circuit voltage (U_{OC}), which almost reaches its maximum value even in low light situations
- the maximum power point (MPP), at which the solar panel can provide the maximum output power

The voltage of the MPP (here: U_{MPP}) lies typically 20% below U_{OC} , the current of the MPP (here: I_{MPP}) lies typically 5% below I_{SC} . In case there are no definite values for the simulated solar cell available, I_{MPP} and U_{MPP} can be set to this rule of thumb. The device limits the I_{MPP} value to I_{SC} as upper limit, the same applies to U_{MPP} and U_{OC} .



3.10.13.2 Safety notices



Due to high capacities on the DC outputs of the power supplies of this series, not every available solar inverter can be operated without problems. Check the technical specifications of the solar inverter and probably contact the manufacturer for an evaluation. In case option HS is installed in the device (see „1.9.5. Options“), the result of operating critical inverters can be optimised.

3.10.13.3 Usage

In the PV table function, which is based upon the XY generator with IU characteristics, the MPP is defined by the two adjustable parameters U_{MPP} and I_{MPP} (also see diagram below). These parameters are usually stated in data sheets of solar panels and have to be entered here.

The following parameters can be set for the PV table function:

Value	Range	Description
Uoc	U_{MPP} ...Nominal device voltage	Open circuit voltage at no load
Isc	I_{MPP} ...Nominal device current	Short-circuit current at max. load and low voltage
Umpp	0 V...Uoc	DC output voltage at the MPP
Imp	0 A...Isc	DC output current at the MPP

Schematic diagram:

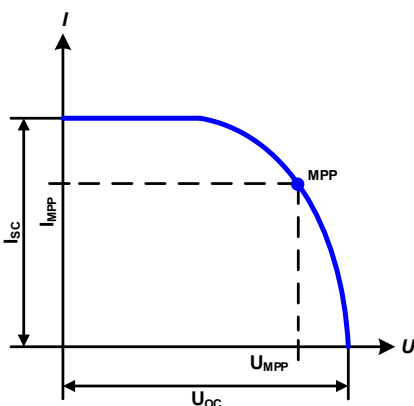

Application and result:



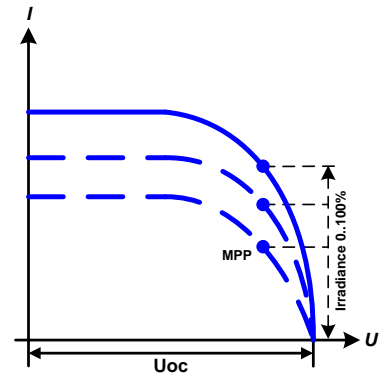

Adjust all four parameters on screen to the desired values. Whether the calculated IU and P curves, which result from those values, make sense or not can be verified with a tool (Excel table or small software), which is either included with the device on USB stick or can be obtained upon request. The tool visualises the curves as calculated from the adjusted values.

While the simulation is running, the user can see from the actual values (voltage, current, power) of the DC output, where the operating point of the power supply resp. of the simulated solar panel is. The adjustable value **Irradiance** (0%...100% in 1% steps, see screenshot below) helps to simulate different light situations from darkness (no power output) to the minimal amount of light that is required to make the panel provide full power.

Varying this parameter shifts the MPP and the PV curve along the Y axis. Also see diagram to the right. The value Irradiance is here used as a factor for the current I_{mpp} . The curve itself isn't permanently re-calculated.



► How to configure the PV table

- In the function generator menu tap on , then  and then .
- Adjust the four parameters as required for the simulation.
- Do not forget to adjust the global limits for voltage and power in the next screen which you can access with touch area . The voltage (U) setting should be at least as high as U_{oc} , or higher.
- After setting the values for the required signal generation, tap on touch area .

While loading, the IU function is calculated and sent to the internal XY generator. After this, the function is ready to run.

From the screen where the XY function generator is controlled manually (start/stop), you can go back to the first screen of PV table function and use the formerly locked touch area to save the table to USB stick. In order to do so, follow the on-screen instructions. The table can be used to analyze the values or to visualize it in Excel or similar tools.

► How to work with the PV table function

- With an appropriate load connected, for example a solar inverter, start the function as described in 3.10.4.1.
- Adjust value **Irradiance** with any rotary knob between 100% (default) and 0%, in order to reproduce different light situations for the simulated panel. The actual values on the display indicate the working point and can show whether the simulation has arrived at the MPP or not.
- Stop the function run anytime as described in 3.10.4.1.

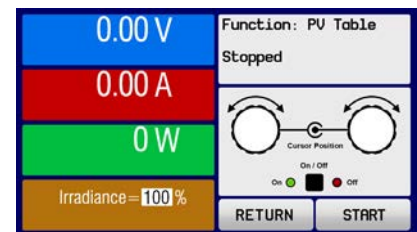

3.10.14 FC table function (fuel cell)

3.10.14.1 Preface

The FC table function is used to simulate the characteristics of voltage and current of a fuel cell. This is achieved by setting up some parameters which define points on a typical fuel cell curve, which is then calculated as UI table and passed to the internal function generator.

The user has to adjust value for four support points. The device will request to enter them step by step, indicating the actual point on screen with small graphics. When finished, these points will be used to calculate the curve.

Generally, following rules apply when setting up those values:

- $U_{Point1} > U_{Point2} > U_{Point3} > U_{Point4}$
- $I_{Point4} > I_{Point3} > I_{Point2} > I_{Point1}$
- Values of zero are not accepted

It means, the voltage has to decrease from point 1 to point 4, while the current has to increase. In case the rules are not followed, the device will reject the values with an error and reset them to 0.



3.10.14.2 Usage

The following parameters can be set for the FC table function:

Value	Range	Description
Point 1: Uoc	0 V...U _{Nom}	Open circuit voltage at no load
Point 2+3: U	0 V...U _{Nom}	Voltage and current define the position of these two points in the U-I coordinate system, which represent two supporting points on the curve to be calculated
Point 2+3: I	0 A...I _{Nom}	
Point 4: Isc	0 A...I _{Nom}	DC output current during short-circuit



All these parameters all freely adjustable and thus an unrealistic curve could result. In some situations, the device would show a "Calculation error" after you tapped LOAD and loading of the function will be aborted. In this situation, check your settings, probably revise and try again.

Schematic diagram:

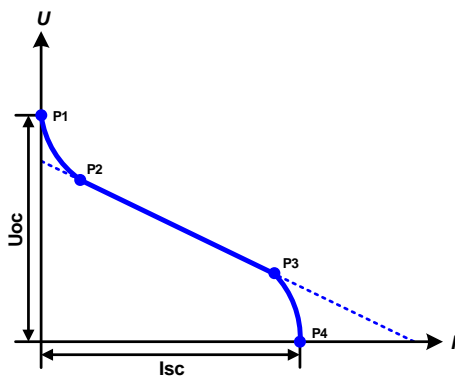





Application and result:

After setting up the four supporting points P1 thru P4, whereas P1 is at position Uoc and 0 A and P4 is at position Isc and 0 V, the device will calculate the function as UI table and load it to the XY generator.

Depending on the load current, which can be between 0 A and Isc, the device will set a variable output voltage, whose progress between 0 V and Uoc should result in a curve similar to the one depicted to the left.

The slope between P2 and P3 is depending on the values adjusted for P2 and P3 and can be freely modified as long as P3's voltage is lower than the one of P2 and P3's current is higher than the one of P2.

► How to configure the FC table

- In the function generator menu tap on , then  and then .
- Adjust the parameters of the four supporting points, as required for the simulation.
- Do not forget to adjust the global limits for voltage and power in the screen which you can access with touch area .
- After setting the values for the required signal generation, tap on touch area .

After the function has been loaded to the internal XY generator, the simulation is ready to start.



The function can be saved to USB stick as table, as well as read via any of the digital interfaces. In remote control, the function can't be loaded or controlled.

From the screen where the XY function generator is controlled manually (start/stop), you can go back to the first screen of the FC table function and use the formerly locked touch area to save the table to USB stick. In order to do so, follow the on-screen instructions. The table can be used to analyze the values or to visualize it in Excel or similar tools.

► How to work with the FC table function

- With an appropriate load connected, for example a DC-DC converter, start the function as described in 3.10.4.1.
- The output voltage will be set depending on the load current, which is defined by the connected load, and will decrease with increasing current. Without any load, the voltage will rise to the adjusted Uoc value.
- Stop the function run anytime as described in 3.10.4.1.

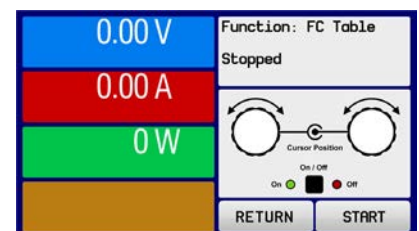

3.10.15 Extended PV function according to EN 50530

3.10.15.1 Introduction

This extended PV table function according to standard EN 50530 is used to simulate solar panels in order to test and rate solar inverters. It's available since firmware versions KE 2.19 and HMI 2.11 and offers manual configuration and control, as well as remote control. It's also based on the XY generator, same as the simple PV table function from 3.10.13, but enables more specific tests and evaluations due to adjustable parameters. Which parameters are available is explained below. The impact of the parameters on the PV curve and the simulation is described in the standard paper of EN 50530, which user can refer to in case more detailed description is required. This section only deals about configuration and control of the PV simulation.

3.10.15.2 Differences to the basic PV function

The extended PV function has five additional or different characteristics compared to the simple PV function:

- The simulation distinguishes between a single test run and an automatic test run, called day trend, which is based upon a user-defined curve built from up to 100,000 points
- There are two invariable and one variable panel technology available to choose from
- There are more parameters available to adjust during runtime
- It allows for data recording during runtime and to save the data either to USB stick or read via digital interface
- It allows to select between two different parameter sets to adjust during runtime

3.10.15.3 Technologies and technology parameters

When configuring the PV simulation it's required to select the solar panel technology to simulate. The technologies **cSI** and **Thin film** are invariable in their parameters, while technology **Manual** is variable in all parameters, but within specific limits. This allows for the variation of the simulation and when copying the fixed parameter values from **cSi** or **Thin film** to **Manual**, it even enables their variation as well.

One advantage of the invariable technologies is that their technology parameters are automatically set to their defined defaults in the configuration procedure.

Overview of the technology parameters used in the PV curve calculation and their defaults:

Abbr.	Name	Manual	cSI	Thin film	Unit
FFu	Fill factor for voltage	>0...1 (0.8)	0.8	0.72	-
FFi	Fill factor for current	>0...1 (0.9)	0.9	0.8	-
Cu	Scaling factor for U_{OC} ⁽¹⁾	>0...1 (0.08593)	0.08593	0.08419	-
Cr	Scaling factor for U_{OC} ⁽¹⁾	>0...1 (0.000109)	0.000109	0.0001476	m ² /W
Cg	Scaling factor for U_{OC} ⁽¹⁾	>0...1 (0.002514)	0.002514	0.001252	W/m ²
alpha	Temperature coefficient for I_{SC} ⁽²⁾	>0...1 (0.0004)	0.0004	0.0002	1/°C
beta	Temperature coefficient for U_{OC} ⁽¹⁾	-1...<0 (-0.004)	-0.004	-0.002	1/°C

(1 U_{OC} = Open circuit voltage of a solar panel)

(2 I_{SC} = Short-circuit current (=max. current) of a solar panel)

3.10.15.4 Simulation mode

Apart from the panel technology there is also a simulation mode to select. Four options:

Mode U/I	Controllable simulation. Voltage (U_{MPP} , in V) and current (I_{MPP} , in A) in the maximum power point (MPP) are variable during runtime. The purpose of this mode is to directly shift the MPP into various directions.
Mode E/T	Controllable simulation. During runtime, the irradiation (E from german "Einstrahlung", in W/m ²) and surface temperature (T, in °C) of the simulated solar panel are adjustable. This also impacts the curve and the resulting MPP. The purpose of this mode is to analyse the impact of temperature and/or irradiation on the performance of a solar panel.
Mode DAY U/I	Automatic simulation run, processing a day trend curve consisting of up to 100,000 points defined by values for U_{MPP} , I_{MPP} and time.
Mode DAY E/T	Automatic simulation run, processing a day trend curve consisting of up to 100,000 points defined by values for irradiation, temperature and time.

3.10.15.5 Day trend

The so-called day trend is a special simulation mode for long-term tests. It processes a curve consisting of up to 100,000 user-definable points. For every processed point on that curve, the PV curve is calculated anew.

Every point is defined by 3 values of which one is the dwell time. When defining long dwell times the day trend curve can be supported by an interpolation feature which can be optionally activated. It will calculate and set intermediate points between two succeeding curve points. Hence it should be considered to run the day trend with or without interpolation.

The day curve points have to be loaded into the device, either from a CSV file on USB stick or via digital interface. The user selects the number of points according to the requirements of the simulation.

Formats of the CSV files to load from USB stick when manually configuring the function:

- For **Mode DAY E/T** (required file name format: PV_DAY_ET_<arbitrary_text>.csv)

	A	B	C	D
1	1	100	25	300000
2	2	101	25	2000
3	3	102	25	2000
4	4	103	25	2000
5	5	104	25	2000
6	6	105	25	2000
7	7	106	25	2000
8	8	107	25	2000
9	9	108	25	2000

Column A = **Index**

An ascending number between 1 and 100,000 (the first empty index will cause the simulation to stop)

Column B = **Irradiation (E)** in W/m²

Allowed range: 0...1500

Column C = **Temperature (T)** in °C

Allowed range: -40...80

Column D = **Dwell time** in milliseconds (ms)

Allowed range: 500...1.800.000

- For **Mode DAY UI** (required file name format: PV_DAY_UI_<arbitrary_text>.csv)



Attention! The values in columns B and C are real values which must not exceed the ratings of the device or the device will neglect to load the file.

	A	B	C	D
1	1	63.5	120.3	500
2	2	63.6	121.1	500
3	3	63.7	121.9	500
4	4	63.8	122.7	500
5	5	63.9	123.5	500
6	6	64	124.3	500
7	7	64.1	125.1	500
8	8	64.2	125.9	500
9	9	64.3	126.7	500

Column A = **Index**

An ascending number between 1 and 100,000 (the first empty index will cause the simulation to stop)

Column B = **Voltage U_{MPP}** in V

Allowed range: 0...rated output voltage of the device

Column C = **Current I_{MPP}** in A

Allowed range: 0...rated output current of the device

Column D = **Dwell time** in milliseconds (ms)

Allowed range: 500...1.800.000



The number format and the column separator in the CSV files is determined by the regional settings of the PC or the software used to create the files. The format must match the selection for the device setting "USB file separator format" in the General Settings menu of the device, else the device would neglect loading the file. For example, an american Excel should by default use the dot as decimal separator and the comma as column separator, which would match the selection "USB file separator format = US".

3.10.15.6 Interpolation

The interpolation feature can calculate and set intermediate steps when running the PV function in day trend mode, i. e. **DAY E/T** or **DAY UI**. The calculation is always done between two succeeding points on the day trend curve. The dwell time of every curve point is adjustable between 500 and 1,800,000 milliseconds (see above, format of the day trend data file). While there are no extra points calculated when using the minimum time of 500 ms, following applies to higher dwell time definitions:

- The number of intermediate steps is determined from the dwell time and spread as equally as possible, where any of the steps can have its own dwell time between 500 and 999 ms
- The intermediate steps also respect the slope between the current and the next day trend curve point and thus every step also includes a corresponding value alteration

Visualisation:

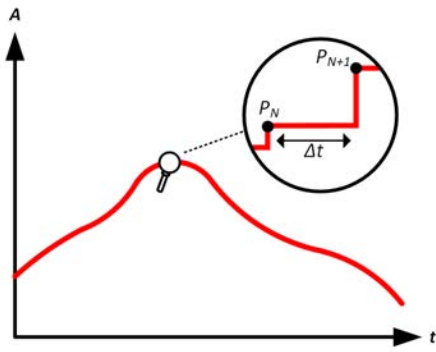

Without interpolation - the curve results in steps

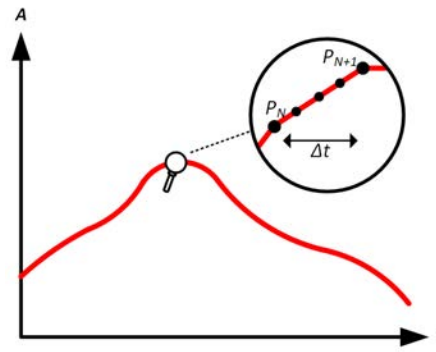

With interpolation - the curve remains linear

An example: the dwell time of the 3450th curve point is defined as 3 minutes, which is 180 seconds. There will be $180 / 0.5 - 1 = 359$ intermediate steps calculated and set until reaching the 3451st point. In mode DAY U/I the MPP voltage changes from 75 V to 80 V and the MPP current changes from 18 A to 19 A. When calculated, this would mean a $\Delta U/\Delta t$ of 27.7 mV/s and a $\Delta I/\Delta t$ of 5.5 mA/s. Depending on the device in use, such small steps in voltage or current may not be doable. However, the device would try to set the first intermediate step with 75.0138 V and 18.0027 A.

3.10.15.7 Data recording

There is the option to record data during the simulation run, in any mode. The data can be stored to USB stick once the simulation is finished or read via digital interface, which even allows for reading the data while the simulation is still running.

As long as the simulation is running, the device will record one data set every 100 ms into an internal buffer. This interval isn't adjustable. The max. number of data sets, here also called indexes, is 576,000. This results in a max. record time of 16 hours. The indexes are internally counted with every new record. When reaching the max. number, the index will restart from 1, overwriting former data. Every index will contain 6 values.

When configuring the PV simulation, the recording feature is locked at first (button greyed out). Only when stopping the simulation and leaving the control screen back to the configuration, the button becomes accessible. It then allows to store a CSV with a specific number of rows. This number depends on the current index counter. Contrary to remote control where it's possible to address every index of the max. 576,000 the save to USB feature will always store all indexes between 1 and the counter. Every next simulation run also resets the counter.

CSV file format when saving the recorded data to USB stick (in the example all values are with unit):

	A	B	C	D	E	F	G
1	Index	U actual	I actual	P actual	Umpp	Impp	Pmpp
2	1	0,29V	0,000A	0,0W	0,00V	0,000A	0,0W
3	2	0,29V	0,000A	0,0W	0,00V	0,000A	0,0W
4	3	0,29V	0,000A	0,0W	0,00V	0,000A	0,0W
5	4	0,29V	0,000A	0,0W	0,00V	0,000A	0,0W
6	5	0,30V	0,000A	0,0W	0,00V	0,000A	0,0W
7	6	0,28V	0,000A	0,0W	0,00V	0,000A	0,0W
8	7	0,28V	0,000A	0,0W	0,00V	0,000A	0,0W
9	8	0,28V	0,000A	0,0W	0,00V	0,000A	0,0W

Index = Ascending number

Uactual = Actual voltage on the DC output

Iactual = Actual current on the DC output

Pactual = Actual power on the DC output

Umpp / Impp / Pmpp = Voltage, current and power in the MPP of the currently calculated PV curve



The global parameter "USB logging with units (V,A,W)" in the General Settings of the device MENU selects whether the values in the CSV file are with or without physical unit. Default is with unit. Another parameter, "USB decimal point format" selects whether the device saves the CSV with comma (US) or semicolon (Standard) and defines the decimal point (dot and comma). The example CSV above shows the european format with decimal comma.

3.10.15.8 Configuration step by step



Starting point

In MENU->Function Generator->2nd page->XY-Table you will find the PV functions. Select **PV DIN EN 50530**.



Step 1: Technology selection

The extended PV function requires to select the panel technology of the solar panel which is going to be simulated. In case **cSI** or **Thin Film** don't match your requirements or you are not sure about their technology parameters, select **Manual**.

When selecting **Thin film** or **cSI** the configuration continues with **Step 2**.

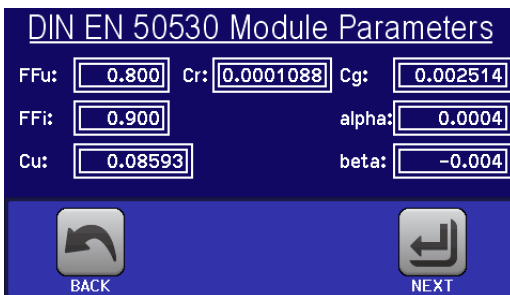

Step 1-1: Adjust technology parameters

If technology **Manual** was selected in the previous screen, all displayed technology parameters can be adjusted by tapping on them and entering the desired value. It's recommended to adjust these values very carefully, because wrong settings can result in a PV curve which doesn't work as expected.

When resetting the device, these values are reset to defaults which are the same as with technology **cSI**. Also see the overview in 3.10.15.3. It means they don't necessarily have to be adjusted. If any of the other technologies was selected, this screen would be skipped and these parameters set to the defined values.



Step 2: Enter the solar panel's base parameters

The open circuit voltage (U_{OC}), the short-circuit current (I_{SC}), as well as voltage (U_{MPP}) and current (I_{MPP}) in the expected MPP are the base parameters to calculate a PV curve from. U_{OC} and I_{SC} are upper limits which are usually read from the data sheet of a solar panel and entered here for the simulation. Two parameters each are connected via the fill factors:

$$U_{MPP} = U_{OC} \times FFu \quad / \quad I_{MPP} = I_{SC} \times FFi$$



Step 3: Select simulation mode

For a description of the available simulation modes see 3.10.15.4.

Furthermore, the recording feature can be enabled (=activated) here. The recorded data can later be stored to USB stick as CSV file with button **SAVE records to USB**, after returning to this screen from the simulation run. Also see section 3.10.15.7.

When selecting **E/T** or **U/I** the configuration continues with **Step 4**.

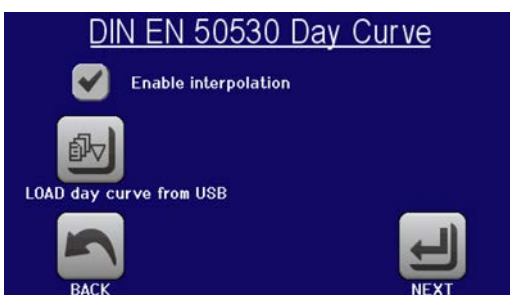

Step 3-1: Load day trend data

If mode **DAY E/T** or **DAY U/I** was selected this additional screen will appear where you can load the required day trend data (1-100,000 points) with button **LOAD day curve from USB** from USB stick and from a CSV file with a specific format (see 3.10.15.5) and name (see 1.9.6.5).

There is furthermore the option to enable (=activate) the interpolation feature (see 3.10.15.6).



Step 4: Global limits

This configuration screen allows to limit voltage and power globally for the simulation. The current, in this table based simulation, is taken from the calculated PV table which also is an IU table.

The output voltage of the power supply is already defined by setting up U_{oc} in step 2, so it's recommended to adjust value U to same or higher, else the PV curve may not be working as expected. The power should not be limited at all.

Recommendation: leave both values untouched

The configuration will be finished and the settings submitted with button . The function generator would then switch to control mode.

3.10.15.9 Controlling the simulation

After loading the configured parameters the FG will switch to control mode. Now the simulation can be started with either the "On/Off" button or touch area .

According to the configured simulation mode, the orange-brown display area would show the adjustable simulation parameters, which could only be modified via direct input, not by the rotary knobs, because with every step of the knob the curve would be re-calculated.

The screen example on the right shows simulation mode **E/T**.

In case any of the day trend modes would have been configured, the display area would be empty. These modes run automatically once started and will stop when the total time of all points' dwell time is reached. The other modes, **E/T** and **U/I**, would only stop by user interaction or due to a device alarm.

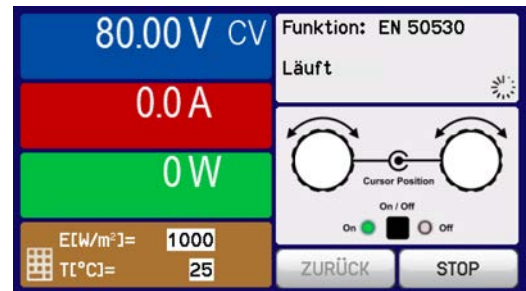

3.10.15.10 Stop criteria

The simulation run could unintentionally stop due to several reasons:

1. A device alarm occurred, which would switch off the DC output (PF, OVP, OCP, OPP)
2. An user event occurred whose action has been defined to cause an alarm, which means to switch off DC
3. Day trend mode has finished

Situation 2 can be avoided by carefully setting up other parameters, unrelated to the function generator. With the simulation stop in all three situation the data recording would also stop.

3.10.15.11 Test analysis

After simulation stop by whatever reason recorded data can be saved to USB stick or read via digital interface, of course only if data recording has been activated in the configuration. Activating the data recording feature during the simulation run isn't possible when manually controlling the FG, but in remote control. When saving to USB stick, it would always save all data recorded until the current index counter. Via digital interface there is the option to read any portion of the data, which will also have an impact on the time required to read the data.

The data can later be used to visualise, analyse and determine characteristics of the simulated solar panel and also of the solar inverter which is usually used as load when running such tests. More details can be found in the standard paper.

3.10.15.12 Reading the PV curve

The last PV curve (or table) which has been calculated during the simulation run can later be read from the device via digital interface (partly or completely) or stored to USB stick. This can serve to verify the adjusted parameters. When running mode DAY E/T or DAY U/I this makes less sense, because there the curve would be re-calculated with every processed index and the read curve would always be the one belonging to the last day trend curve point.

When reading the PV table, you will receive up to 4096 current values. The table data could be visualised in an XY diagram in tools like Excel.

3.10.16 Remote control of the function generator

The function generator can be remotely controlled, but configuration and control of the functions with individual commands is different from manual operation. The external documentation “Programming Guide ModBus & SCPI” on the included USB stick explains the approach. In general the following items apply:

- The function generator isn't directly controllable via the analog interface; the only impact to the function run can come from pin REM-SB switching the DC output off, which will pause the function, so it could continue later on with pin REM-SB switching the DC output on again and in case the function hasn't been stopped otherwise.
- The function generator is unavailable if R mode (resistance) is activated

3.11 Other applications

3.11.1 Parallel operation in master-slave (MS)

Multiple devices of same kind and model can be connected in parallel in order to create a system with higher total current and hence higher power. This can be done using the standard models with display and control panel or the new slave models (PSI 9000 3U Slave, available since January 2017). These models are intended to run as slave only and thus have no display and cheaper. Only disadvantage: the slave models are only available as 15 kW versions, so they only match the 15 kW standard models.

For parallel operation in master-slave mode the units are usually connected with their DC outputs, their Share bus and their master-slave bus, which is a digital bus that makes the system work as one big unit regarding adjusted values, actual values and status.

The Share bus is intended to balance the units dynamically in their output voltage, i.e. in CV mode, especially if the master unit runs a function like sine wave etc. In order for this bus to work correctly, at least the DC minus poles of all units have to be connected, because DC minus is the reference for the Share bus.

Principle view (without load):

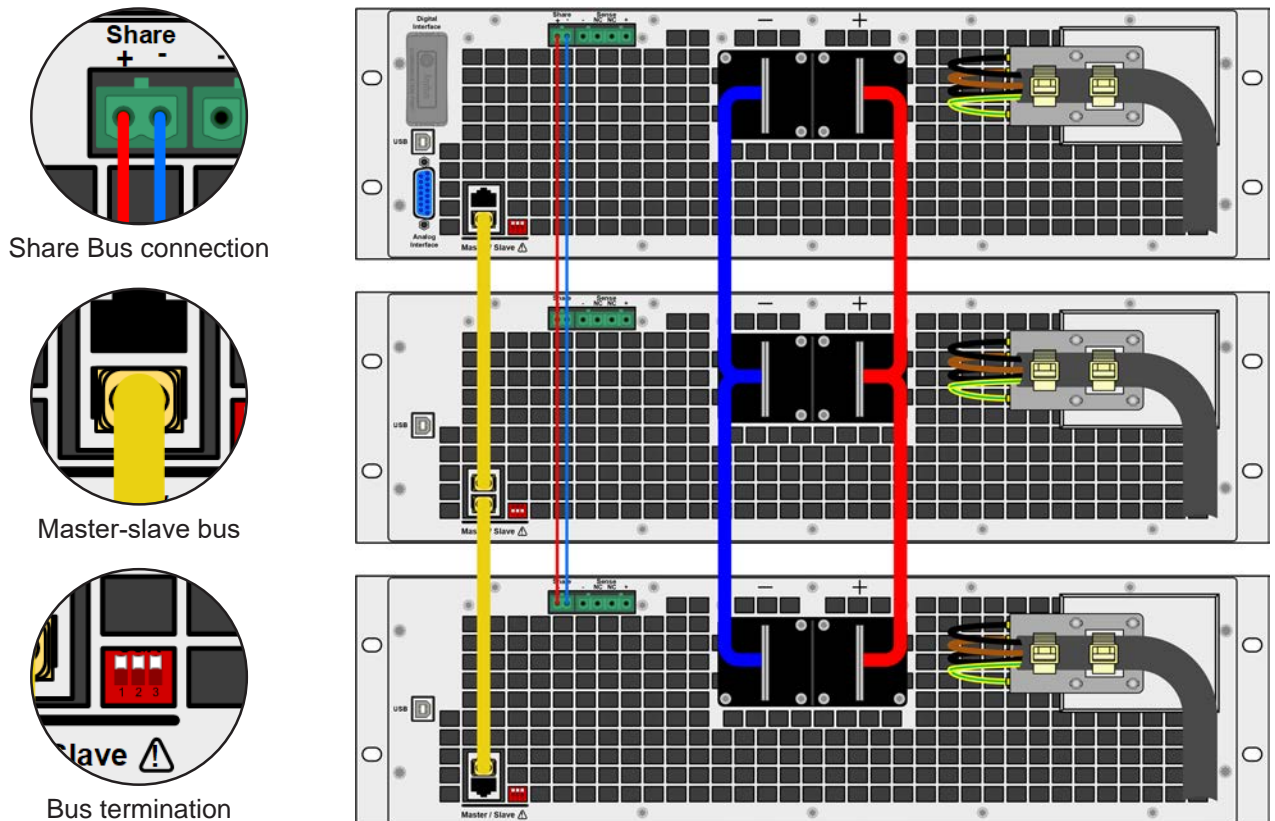

3.11.1.1 Restrictions

Compared to normal operation of a single device, master-slave operation has some *restrictions*:

- The MS system reacts partly different in alarm situations (see below in 3.11.1.6)
- Using the Share bus makes the system react as dynamic as possible, but it's still not as dynamic as single unit operation

3.11.1.2 Wiring the DC outputs

The DC output of every unit in the parallel operation is connected with correct polarity to the next unit, using cables or copper bars with a cross section according to the total system current and with short as possible length.



Share bus operation requires all involved cables, such as the DC cables between the DC outputs of the devices, to be as short as possible and with low inductance. Ideally, the parallel connection is accomplished with copper bars of high cross section.

3.11.1.3 Wiring the Share bus

The Share bus is wired from unit to unit with an ideally twisted pair of cables with non-critical cross section. We recommend to use 0.5 mm² to 1 mm².



- The Share bus is poled. Take care for correct polarity of the wiring!
- In order for the Share bus to work correctly it requires at least to connect all DC minus outputs of the devices



A max. of 16 units can be connected via Share bus.

3.11.1.4 Wiring and set-up of the digital master-slave bus

The master-slave connectors are built-in and can be connected via network cables (≥CAT3, patch cable). After this, MS can be configured manually (recommended) or by remote control. The following applies:

- A maximum of 16 units can be connected via the bus: 1 master and up to 15 slaves.
- Connection only between devices of same kind, i.e. power supply to power supply, and of the same model, such as PSI 9080-170 3U to PSI 9080-170 3U.
- Units at the end of the bus must be terminated (see below)



The master-slave bus must not be wired using crossover cables!

Later operation of the MS system implies:

- The master unit displays, or makes available to be read by the remote controller, the sum of the actual values of all the units
- The ranges for setting the values, adjustment limits, protections (OVP etc.) and user events (UVD etc.) of the master are adapted to the total number of units. Thus, if e.g. 5 units each with a power of 5 kW are connected together to a 25 kW system, then the master can be set in the range 0...25 kW.
- Slaves are no operable as long as being controlled by the master
- Slaves which haven't yet been initialized by the master will show the alarm "MSP" either in the display or via LED "Error" ('SLAVE' models from PSI 9000 3U Slave series). The same alarm is signaled upon MS bus errors.

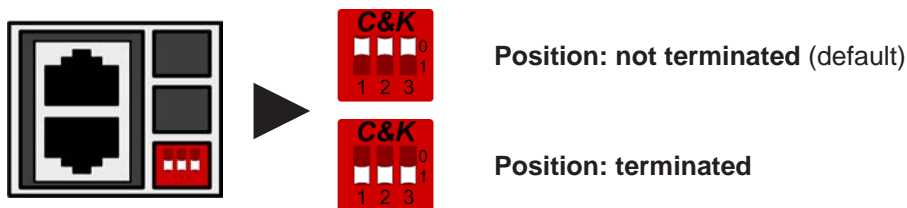

► How to connect the digital master-slave bus

1. Switch off all units that are to be connected and connect them with network cables (CAT3 or better, cables not included). It doesn't matter which of the two master-slave connection sockets (RJ45, backside) is connected to the next unit.
2. Depending on the desired configuration the units can then be connected at the DC side. The two units at the beginning and end of the chain should be terminated, if long connection cables are used. This is achieved using a 3-pole DIP switch which is positioned on the back side of the unit next to the MS connectors.



Now the master-slave system has to be configured on each other unit. It's recommended to configure all the slave units first and then the master unit.

► Step 1: Configuring all slave units (standard models with TFT display)



1. Enter **MENU** then GENERAL SETTINGS and press  until reaching the master-slave settings.
2. Activate the MS mode with touch area **SLAVE**. A warning requester will appear which has to be acknowledged with OK, otherwise the change will be reverted.
3. Accept the settings with the touch area  and return to the main page.

► Step 1: Configuring all slave units (PSI 9000 3U Slave series models without display)

1. Connect the Slave series model via the rear USB port to a PC.
2. Start the software EA Power Control (included with the device on USB stick) and let the software find the device.
3. Open the app “Settings” for the particular unit, switch to tab “Master-Slave” and set the parameter “Master-slave mode” to “SLAVE”.

The slave is then configured for master-slave. Repeat the procedure for all other slave units.

► Step 2: Configuring the master unit

1. Enter **MENU** then GENERAL SETTINGS and press  until reaching the master-slave settings.
2. Specify the unit as master with touch area **MASTER**. A warning requester will appear which has to be acknowledged with OK, otherwise the change will be reverted.
3. Accept the settings with the touch area  and return to the main page.

► Step 3: Initializing the master

The master unit and the whole master-slave system must now be initialized, which is done automatically after the master unit has been activated for MS. In the main page, after quitting the setting menus, a pop-up will appear:



Tapping INITIALIZE can be used to repeat the search again, in case the detected number of slaves is less than expected. This can be necessary if not all units are set as SLAVE or the cabling/termination is still not OK. The result window shows the number of slaves and the total current and power of the MS system.

In case there are no slaves found or not present, i.e. not powered, the master will still initialise the MS system with only itself.



The initialising process of the master and the master-slave system will, as long as MS mode is still activated, be repeated each time the units are powered. The initialization can be repeated anytime via the MENU in GENERAL SETTINGS.

3.11.1.5 Operating the master-slave system

After successful configuration and initialization of the master and slave units, they will show their status in the displays. While the master merely shows “Master” in the status area, the slave(s) will continuously show like this, as long they are in remote control by the master:

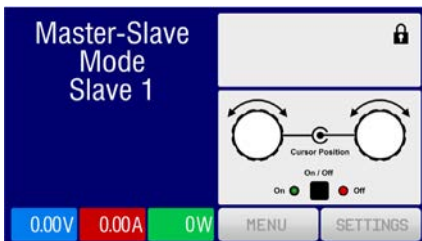

It means, as long as a slave unit is in control by the master, it won't display any set values, but actual values, and it will show the DC output status and possible alarms.

The slaves can no longer be controlled manually or remotely, neither via the analog nor via digital interfaces. They can, if needed, be monitored by reading actual values and status.

The display on the master unit changes after initialization and all set values are reset. The master now displays the set and actual values of the total system. Depending on the number of units, the total current and power will multiply. The following applies:

- The master can be treated like a standalone unit
- The master shares the set values across the slaves and controls them
- The master is remotely controllable via the analog or digital interfaces
- All settings for the set values U, I and P (supervision, limits etc.) should be adapted to the new total values
- All initialised slaves will reset any limits (U_{Min} , I_{Max} etc.), supervision thresholds (OVP, OPP etc.) and event settings (UCD, OVD etc.) to default values, so these don't interfere the control by the master. As soon as these values are modified on the master, they are transferred 1:1 to the slaves. Later, during operation, it might occur that a slave causes an alarm or event rather than the master, due to imbalanced current or slightly faster reaction.



In order to easily restore all these settings values to what was before activating MS operation, it's recommended to make use of the user profiles (see „3.9. Loading and saving a user profile“)

- If one or more slaves report an device alarm, it will be displayed on the master and must be acknowledged there so that the slave(s) can continue their operation. Since most alarms cause the DC outputs to be switched off and they can only be reinstated on the master unit, user interaction (operator) may be required or alarm handling by a remote control software.
- Loss of connection to any slave will result in shutdown of all DC outputs, as a safety measure, and the master will report this situation in the display with a pop-up “Master-slave security mode”. Then the MS system has to be re-initialised, either with or without re-establishing connection to the disconnected unit(s) before.
- All units, even the slaves, can be externally shut down on the DC outputs using the pin REM-SB of the analog interface. This can be used as some kind of emergency off, where usually a contact (maker or breaker) is wired to this pin on all units in parallel.

3.11.1.6 Alarms and other problem situations

Master-slave operation, due to the connection of multiple units and their interaction, can cause additional problem situations which do not occur when operating individual units. For such occurrences the following regulations have been defined:

- Generally, if the master loses connection to any slave, it will generate an MSP (master-slave protection) alarm, pop up a message on the screen and switch off its DC output. The slaves will fall back to single operation mode, but also switch off their DC output. The MSP alarm can be deleted by either initialising the master-slave system again. This can be done either in the MSP alarm pop-up screen or in the MENU of the master or via remote control. Alternatively, the alarm is also cleared by deactivating master-slave on the master unit
- If one or more slave units are cut from AC supply (power switch, blackout, supply undervoltage) and come back later, they're not automatically initialised and included again in the MS system. Then the init has to be repeated.
- If the master unit is cut from AC supply (power switch, blackout) and comes back later, the unit will automatically initialise the MS system again, finding and integrating all active slaves. In this case, MS can be restored automatically.
- If multiple units are defined as master the master-slave system can't be initialized

In situations where one or multiple units generate a device alarm like OVP etc. following applies:

- Any alarm of a slave is indicated on the slave's display and on the master's display
- If multiple alarms happen simultaneously, the master only indicates the most recent one. In this case, the particular alarms can be read from the slave units displays or via digital interface during remote control or remote supervision.
- All units in the MS system supervise their own values regarding overvoltage, overcurrent and overpower and in case of alarm they report the alarm to the master. In situations where the current is probably not balanced between the units, it can occur that one unit generates an OCP alarm though the global OCP limit of the MS system was not reached. The same can occur with the OPP alarm.

3.11.1.7 Important to know



- *In case one or several units of a parallel system are not going to be used and remain switched off, depending on the number of active units and the dynamics of the operation it may become necessary to disconnect the inactive units from the Share bus, because even when not powered the units can have a negative impact on the Share bus due to their impedance.*
- *Slave devices with a display have an extra option in the configuration page for master-slave which can be activated to switch off the back light of the display after some time. This can be helpful, because after initialization of the MS system the slaves' displays are not needed anymore. The feature itself is, however, identical to the option in the HMI settings.*

3.11.2 Series connection

Series connection of two or multiple devices is basically possible. But for reasons of safety and isolation, following restrictions apply:



- Both, negative (DC-) and positive (DC+) output poles, are connected to PE via type X capacitors
- None DC minus pole of any unit in the series connection must have a potential against ground (PE) higher than specified in the technical data! The maximum allowed potential shift varies from model to model and is different for DC plus and DC minus
- The Share Bus must not be wired and used!
- Remote sensing must not be used!
- Series connection is only allowed with devices of the same kind and model, i.e. power supply with power supply, like for example PS/PSI 9080-170 3U with PSI 9080-170 3U or PS 9080-170 3U

Series connection in Master-Slave mode isn't supported. It means, all units have to be controlled separately regarding set values and DC output status, whether it's manual control or remote control (digital or analog).

Due to the max. allowed potential shift on the DC output certain models are not allowed for series connection at all, like the 1000 V model, because the DC plus there is only isolated up to 1000 V. On the contrary, two 500 V models are eligible for series connection.

Analog interfaces on the units in serial connection can be connected in parallel, because they are galvanically isolated. It's also allowed to ground the GND pins of the analog interfaces connected in parallel, which may happen automatically, when connecting them to a controlling device such as a PC, where grounds are directly tied to PE.

3.11.3 Operation as battery charger

A power supply can be used as a battery charger, but with some restrictions, because it misses a battery supervision and a physical separation from the load in form of a relay or contactor, which is featured with some real battery chargers as a protection.

Following has to be considered:

- No false polarity protection inside! Connecting a battery with false polarity will damage the power supply severely, even if it's not powered.

3.11.4 Two quadrants operation (2QO)

3.11.4.1 Introduction

This way of operating refers to the use of a source, in this case a power supply of series PSI 9000 3U, and a sink, in this case a series ELR 9000 electronic load. The source and the sink function alternately in order to test a device, such as a battery, by deliberately charging and discharging it as part of a functional or final test.

The user can decide whether the system is operated manually or the power supply only as the dominant unit or both devices should be controlled by PC. We recommend to focus on the power supply, which is intended to control the load via the Share Bus connection. The two quadrants operation is only suitable for constant voltage operation (CV).

Clarification:

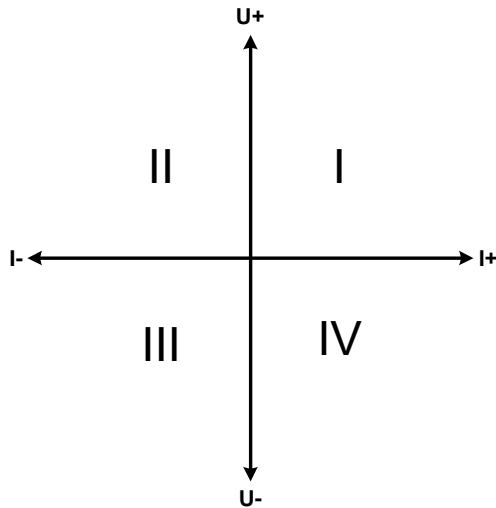
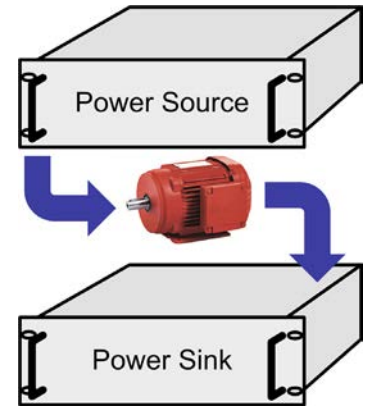

A combination of source and sink can only map the quadrants I + II. This means that only positive voltages are possible. The positive current is generated by the source or application and the negative current flows into the load..

The maximum approved limits for the application should be set in the power supply. This can be done via the interface. The electronic load should preferably be in operating mode CV. The load will then, using the Share Bus, control the output voltage of the power supply.

Typical applications:

- Fuel cells
- Capacitor tests
- Motor driven applications
- Electronic tests where a high dynamic discharge is required.

3.11.4.2 Connecting devices to a 2QO

There are several ways to connect source(s) and sink(s) to make a 2QO:

2QO uses the Share bus and Share bus operation requires short as possible cables with low inductance. It also concerns the distance between blocks of devices, below called "E-LOAD" and "PSU". These blocks must be as close as possible to each other to keep cables short.

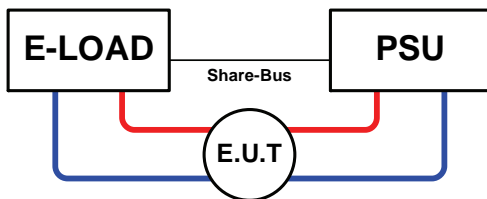

Configuration A:

1 e-load and 1 power supply, plus 1 test object (E.U.T).

This is the most common configuration for 2QO. The nominal values for U,I and P of the two devices should match, such as ELR 9080-170 and PSI 9080-170 3U. The system is controlled by the power supply, which has to be set to "Master" in the setup menu, even if there is no master-slave operation running.

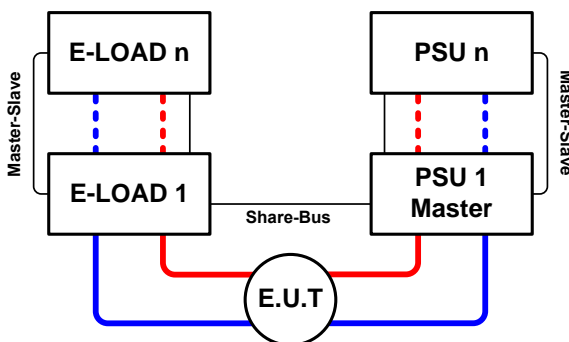

Configuration B:

Multiple e-loads and Multiple power supplies, plus 1 test object (E.U.T), for raising the total performance.

The combination of load units and power supply units each create a block, a system with certain power. Here it's also necessary to match the nominal values, but at least the voltage of the two systems, i.e an 80 V DC input of the loads to a max. 80 V DC output of the power supplies. The max. number of 16 units can't be exceeded. Regarding the Share bus connection, all e-load units have to be slaves, while one of the PSUs has to be set as master.

3.11.4.3 Settings on the devices

Regarding the 2QO operation where the Share bus connection is sufficient, the load unit(s) are required to be set as SLAVE or OFF (unless part of a MS system of loads) in the parameter “Master-slave mode”. The option “PSI/ELR system” has to be activated for the master load of a possibly configured MS system of loads.

On any of the power supplies, preferably PSU 1, master-slave mode must be activated (setting “MASTER”), even if there is only one power supply. Also see 3.4.3.1.

For safety of the connected E.U.T / D.U.T and to prevent damage, we recommend to adjust supervision thresholds like OVP, OCP or OPP on all units to the desired levels, which will then switch off the DC output resp. the DC input in case of excess.

3.11.4.4 Restrictions

After all electronic loads have been connected to the Sharebus with one power supply as master, they can't limit their input voltage anymore to what you adjust as “U set” on the device. The correct voltage level comes from the master unit and has to be adjusted there.

3.11.4.5 Application example

Charging and discharging a battery with 24 V/400 Ah, using configuration A from above.

- Power supply PSI 9080-170 3U with: $I_{\text{Set}} = 40 \text{ A}$ (charging current, 1/10 of capacity), $P_{\text{Set}} = 5000 \text{ W}$
- Electronic load ELR 9080-170 set to: $I_{\text{Set}} = \text{max. discharging current of the battery (eg. 100 A)}$, $P_{\text{Set}} = 3500 \text{ W}$, plus probably UVD = 20 V with event type “Alarm” to stop discharging at a certain low voltage threshold
- Assumption: battery has a voltage of 26 V at test start
- DC input(s) and DC output(s) of all units switched off



In this combination of devices it's recommended to always switch on the DC output of the source first and then the DC input of the sink.

Part 1: Discharge of the battery to 24 V

Setup: Voltage on the power supply set to 24 V, DC output of power supply and DC input of load activated

Reaction: the e-load will load the battery with a maximum current of 100 A in order to discharge it to 24 V. The power supply delivers no current at this moment, because the battery voltage is still higher than what is adjusted on the power supply. The load will gradually reduce the input current in order to maintain the battery voltage at 24 V. Once the battery voltage has reached 24 V with a discharge current of approx. 0 A, the voltage will be maintained at this level by charging from the power supply.



The power supply determines the voltage setting of the load via the Share bus. In order to avoid deep discharge of the battery due to accidentally setting the voltage on the power to a very low value, it's recommended to configure the undervoltage detection feature (UVD) of the load, so it will switch off the DC input when reaching minimum allowed discharge voltage. The settings of the load, as given via the Share bus, can't be read from the load's display.

Part 2: Charging the battery to 27 V

Setup: Voltage on the power supply set to 27 V

Reaction: the power supply will charge the battery with a maximum current of 40 A, which will gradually reduce with increasing voltage as a reaction to the changing internal resistance of the battery. The load absorbs no current at this charging phase, because it's controlled via the Share bus and set to a certain voltage, which is still higher than the actual battery voltage and the actual output voltage of the power supply. When reaching 27 V, the power supply will deliver only the current needed to maintain the battery voltage.

4. Service and maintenance

4.1 Maintenance / cleaning

The device needs no maintenance. Cleaning may be needed for the internal fans, the frequency of cleanse is depending on the ambient conditions. The fans serve to cool the components which are heated by the inherent power loss. Heavily dirt filled fans can lead to insufficient airflow and therefore the DC output would switch off too early due to overheating or possibly lead to defects.

Cleaning the internal fans can be performed with a vacuum cleaner or similar. For this the device needs to be opened.

4.2 Fault finding / diagnosis / repair

If the equipment suddenly performs in an unexpected way, which indicates a fault, or it has an obvious defect, this can't and must not be repaired by the user. Contact the supplier in case of suspicion and elicit the steps to be taken.

It will then usually be necessary to return the device to the supplier (with or without guarantee). If a return for checking or repair is to be carried out, ensure that:

- the supplier has been contacted and it's clarified how and where the equipment should be sent.
- the device is in fully assembled state and in suitable transport packaging, ideally the original packaging.
- optional extras such as an interface module is included if this is in any way connected to the problem.
- a fault description in as much detail as possible is attached.
- if shipping destination is abroad, the necessary customs papers are attached.

4.2.1 Firmware updates



Firmware updates should only be installed when they can eliminate existing bugs in the firmware in the device or contain new features.

The firmware of the control panel (HMI), of the communication unit (KE) and the digital controller (DR), if necessary, is updated via the rear side USB port. For this the software EA Power Control is needed which is included with the device or available as download from our website together with the firmware update, or upon request.

However, be advised not to install updates promptly. Every update includes the risk of an inoperable device or system. We recommend to install updates only if...

- an imminent problem with your device can be solved directly, especially if we suggested to install an update during a support case
- a new feature has been added which you definitely want to use. In this case, the full responsibility is transferred to you.

Following also applies in connection with firmware updates:

- Simple changes in firmwares can have crucial effects on the application the devices are use in. We thus recommend to study the list of changes in the firmware history very thoroughly.
- Newly implemented features may require an updated documentation (user manual and/or programming guide, as well as LabView VIs), which is often delivered only later, sometimes significantly later

4.3 Calibration

4.3.1 Preface

The devices of series PSI 9000 feature a function to re-adjust the most important DC output related values, which can help in case these have moved out of tolerance. The readjustment is intended to compensate small deviations of up to 1% or 2% rated value. There are several reasons which could make it necessary to readjust a unit: component aging, component deterioration, extreme ambient conditions, high frequent use.

In order to determine if a value is out of tolerance, the parameter must first be verified with measurement tools of high accuracy and with at least half the error of the PSI device. Only then a comparison between values displayed on the PSI device and true DC output values is possible.

For example, if you want to verify and possibly readjust the output current of model PSI 9080-510 3U which has 510 A maximum current, stated with a max. error of 0.2%, you can only do that by using a high current shunt with max. 0.1% error or less. Also, when measuring such high currents, it's recommended to keep the process short, in order to avoid the shunt heating up too much. It's furthermore recommended to use a shunt with at least 25% reserve.

When measuring the current with a shunt, the measurement error of the multimeter on the shunt adds to the error of the shunt and the sum of both must not exceed the max. error of the device under calibration.

4.3.2 Preparation

For a successful calibration and readjustment, a few tools and certain ambient conditions are required:

- A measurement device (multimeter) for voltage, with a max. error of half the PSI's voltage error. That measurement device can also be used to measure the shunt voltage when readjusting the current
- If the current is also going to be calibrated: a suitable DC current shunt, ideally specified for at least 1.25 times the max. output current of the PSI and with a max. error that is half or less than the max. current error of the PSI device to calibrate
- Normal ambient temperature of approx. 20-25°C
- Warmed up PSI unit, which has been run for at least 10 minutes under 50% power
- One or two adjustable loads, preferably electronic ones, which are capable of consuming at least 102% of the max. voltage and current of the PSI device and which are calibrated and precise

Before you can start calibrating, a few measures have to be taken:

- Let the PSI device warm up for at least 10 minutes under 50% load, in connection with the voltage / current source
- In case the remote sensing input is going to be calibrated, prepare a cable for the remote sensing connector to DC output, but leave it yet unconnected
- Abort any form of remote control, deactivate master-slave mode, deactivate resistance mode
- Install the shunt between PSI device and load and make sure the shunt is cooled somehow
- Connect external measurement device to the DC output or to the shunt, depending on whether the voltage is going to be calibrated first or the current

4.3.3 Calibration procedure

After the preparation, the device is ready to be calibrated. From now on, a certain sequence of parameter calibration is important. Generally, you don't need to calibrate all three parameters, but it's recommended to do so.

Important:



When calibrating the output voltage, input "Sense" on the rear of the device has to be disconnected.

The calibration procedure, as explained below, is an example with model PSI 9080-170 3U. Other models are treated the same way, with values according to the particular PSI model and the required load.

4.3.3.1 Calibrating the set values

► How to calibrate the output voltage

1. Connect a multimeter to the DC output. Connect a load and set its current to approx. 5% of the nominal current of the power supply, in this example ≈ 8 A, and 0 V (if the load is electronic).
2. While the DC output is switched off tap MENU on the display, then „**General Settings**“, then go down to “**Calibrate device**” and finally tap **START**.
3. In the next screen select: **Voltage calibration**, then **Calibrate output val.** and **NEXT**. The power supply will switch the DC output on, set a certain output voltage and show the measured value as **U-mon**.
4. The next screen requests you to enter the measured output voltage from the multimeter at **Measured value=**. Enter it using the keypad, that appears when tapping the value. Assure yourself the value is correct and submit with **ENTER**.
5. Repeat point 4. for the next three steps (total of four steps).

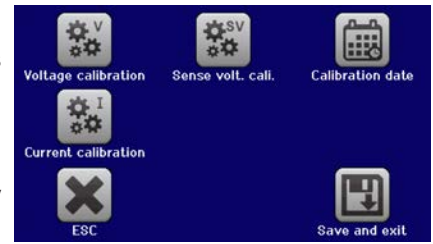

► How to calibrate the output current

1. Set the load to approx. 102% nominal current of the PSI device, for the example model with 170 A this would be 173.4 A, rounded to 174 A.
2. While the DC output is switched off tap MENU on the display, then „**General Settings**“, then go down to “**Calibrate device**” and finally tap **START**.
3. In the next screen select: **Current calibration**, then **Calibrate output val.** and **NEXT**. The device will switch on the DC output, set a certain current limit while loaded by the load/sink and show the measured output current as **I-mon**.
4. The next screen requests you to enter the output current **Measured value=** measured with your shunt. Enter it using the keypad and assure yourself the value is correct and submit with **ENTER**.
5. Repeat point 4. for the next three steps (total of four steps).

4.3.3.2 Calibrating the remote sensing

In case you are generally using the remote sensing feature, it's recommended to also calibrate this feature for best results. The procedure is identical to the calibration of voltage, except for it requires to have the sensing connector (Sense) on the rear to be plugged and connected with correct polarity to the DC output of the PSI.

► How to calibrate the output voltage for remote sensing

1. Connect a load and set its current to approx. 5% of the nominal current of the power supply, in this example ≈ 8 A, and 0 V (if the load is electronic). Connect a multimeter to the DC terminal of the load and connect the remote sensing input (Sense) to the DC terminal of the load with correct polarity.
2. While the DC output is switched off tap MENU on the display, then „**General Settings**“, then go down to “**Calibrate device**” and finally tap **START**.
3. In the next screen select: **Sense volt. cali.**, then **Calibrate output val.** and **NEXT**.
4. The next screen requests you to enter the measured sensing voltage **Measured value=** from your multimeter. Enter it using the keypad, that appears when tapping the value. Assure yourself the value is correct and submit with **ENTER**.
5. Repeat point 4. for the next three steps (total of four steps).

4.3.3.3 Calibrating the actual values

Actual values of output voltage (with and without remote sensing) and output current are calibrated almost the same way as the set values, but here you don't need to enter anything, just confirm the displayed values. Please proceed the above steps and instead of “**Calibrate output val.**” select “**Calibrate actual val.**” in the submenu. After the device shows measured values on display, wait at least 2s for measured value to settle and then tap **NEXT** until you are through all steps.

4.3.3.4 Save and exit

After calibration you may furthermore enter the current date as “calibration date” by tapping  in the selection screen and enter the date in format YYYY / MM / DD.

Last but not least save the calibration data permanently by tapping



 Leaving the calibration selection menu without tapping “Save and exit” will discard calibration data and the procedure would have to be repeated!

5. Contact and support

5.1 General

Repairs, if not otherwise arranged between supplier and customer, will be carried out by the manufacturer. For this the device must generally be returned to the manufacturer. No RMA number is needed. It’s sufficient to package the equipment adequately and send it, together with a detailed description of the fault and, if still under guarantee, a copy of the invoice, to the following address.

5.2 Contact options

Questions or problems with operation of the device, use of optional components, with the documentation or software, can be addressed to technical support either by telephone or e-Mail.

Address	e-Mail	Telephone
US: Intepro Systems America, LP 14662 Franklin Ave Suite E Tustin, CA 92780 UK: Intepro UK Ltd. 9 Lakeside Business Park Swan Lane, Sandhurst Berkshire GU479DN / UK China: Intepro Power Block 7 Fourth Industrial Area Nanyou, Nanshan District Shenzhen, China 518052	Technical support: service@inteproate.com All other issues: sales@inteproate.com	US Support: +1.714.953.2686 UK Support: +44.012.5287.5600 China Support: +0086 755 86500020

Contact Us

sales@inteproate.com

Americas

Intepro Systems America, LP
14662-E Franklin Ave
Tustin, CA 92780
Tel: 1 714 953 2686
sales@inteproate.com
www.inteproate.com

service@inteproate.com

Europe & Africa

Intepro UK Ltd.
9 Lakeside Business Park
Swan Lane, Sandhurst Berkshire
GU47 9DN / UK
Tel: 44 012 5287 5600

www.inteproate.com

Asia & Oceania

Intepro Power Electronics
(Shenzhen) Co., Ltd
No. 828, Block 7,
Fourth Industrial Area
Nanyou, Nashan District
Shenzhen, China 518052
Tel: 0086 755 86500020